



buffet | tabletop | bar

GASTRONOMIE- UND SERVIERARTIKEL

FOOD SERVICE EQUIPMENT
EQUIPAMIENTOS PROFESIONALES
EQUIPEMENT PROFESSIONNEL



2023

SINCE 1933

90
years

run by family

APS – Werkstatt und Bühne für den Genuss

APS – Workshop and stage for enjoyment



family-run company
since 1933

managing director Reinhold Pott | Bastian Becker



- Eigene Produktion in Deutschland
- 25.000 Euro-Palettenlagerplätze
- own production in Germany
- 25,000 Euro pallet storage spaces



buffet | tabletop | bar

Assheuer + Pott GmbH & Co. KG
Talweg 11 | 59846 Sundern
Germany

Phone: +49 (0) 2933 / 97 35 - 0
E-Mail: info@aps-germany.de
aps-germany.de



Keep in touch! [aps_germany](https://www.aps-germany.de)



Visit our website!



Ihr Mehrwert: Inspiration & Service

- ✓ aktuellste Nonfood-Trends im Sortiment
- ✓ hohe Warenverfügbarkeit

Your added value: Inspiration & Service

- ✓ latest nonfood-trends in the range
- ✓ high availability of goods



p. 36



p. 59



p. 99



p. 144



p. 177



p. 207



p. 234



p. 252



p. 276



p. 308



p. 320



p. 324



p. 334



p. 352



p. 364



p. 372



p. 385



p. 414



p. 438



p. 456



p. 475



p. 484



p. 487



p. 491



Buffet & Display

Buffet & Tableware
Melamin

Tableware &
Table Presentation

Baskets

Chafing Dish,
GN Container & Transport

Bar, Café & Drinkware

Kitchen & Servingtools

Covers & Accessories

APS – KNOW-HOW

We only work with the raw material manufacturer who has the best technology in the industry.



MELAMINE

- ✓ 100% pure melamine
- ✓ BPA free, urea free
- ✓ perfect for serving dishes
- ✓ extremely break and shock resistant
- ✓ sustainable due to durability and robustness
- ✓ hygienic surfaces
- ✓ environmentally friendly due to low processing temperature
- ✓ 100% dishwasher safe
- ✓ useable up to max. 70°C

STAINLESS STEEL

Chrome-nickel steel is used in a wide variety of products due to its attractive appearance, as a brightly polished, ground or brushed variant.

- ✓ hygienic surface
- ✓ durable and easy to clean
- ✓ recyclable
- ✓ good temperature conductor
- ✓ 100% dishwasher safe

PLASTIC PP - PS - SAN - TRITAN

- ✓ crystal clear
- ✓ BPA free
- ✓ hygienic surface
- ✓ high resistance to heat
- ✓ easy to clean
- ✓ durable, no disposable plastic
- ✓ recyclable



WOOD

acacia-beech-oak-olive



PORCELAIN



Präzisionsarbeit und Design für Ihren Erfolg

Precision work and design for your success

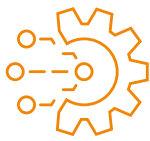

state-of-the-art
manufacturing
technology



eco-friendly



high
professional
usability

QUALITÄT

- ✓ Jedes Produkt muss mehr als zwei Qualitätskontrollen bestehen.
- ✓ Wir verwenden nur 100% reines Material.
- ✓ Jedes Rohmaterial wird streng geprüft.

QUALITY

- ✓ Each product must pass more than two quality checks.
- ✓ We only use 100% pure material.
- ✓ Each raw material is strictly tested.

DESIGN

- ✓ Unsere eigenständig entwickelten Produkte verfügen über zahlreiche Design-Patente im In- und Ausland.
- ✓ Wir entwickeln Produktlösungen für jeden individuellen Kundenbedarf.

DESIGN

- ✓ Our independently developed products have rich / multi design patents at home and abroad.
- ✓ We develop product solutions for every individual customer need.



APS production | Made in Germany



Design team

DEUTSCH

Artikel Seite

A

Abräumwagen	360, 364-365
Abtropfmatte	409
Adapter / Zwischensteg	354, 356
Allzweckgießer	368-369, 416
Antirutschmatte	36, 383
Aschenbecher	427-430
Aufstrichmesser	461
Auslagenplatte	135, 289, 311
Ausgießer	50-51, 260-263, 265-266, 369, 400, 411-412, 470
Ausstellblech	251, 469
Austernmesser	458

B

Backblech	111, 251, 360
Backform	469, 478-479
Backhandschuhe	478
Baquette Korb	92, 310, 316
Bain-Marie	335-336, 338-340, 343-346, 348, 466
Bar-Caddy	409
Barlöffel	399
Barmaß	397, 398
Barmatte	409
Barsieb	400, 464

Becher

39-40, 123, 218, 240, 270, 280, 305, 385, 387-396, 427-432, 434, 467-468, 497	
Becher Emaille	280
Behälter	294-296, 312, 368, 401
Bento Box	156-157
Beschriftungsetiketten	304
Beschriftungskarten	298-301
Besteckablage	218, 351
Besteckbehälter	21, 137-138, 295, 312, 366-367
Besteckkorb	294, 317
Besteckständer	294
Bestecktaschen	277

Beton

141, 168, 260, 272, 274-275, 298, 381, 384
--

Bierglasträger

131, 423

Blattschale Melamin

176, 217, 490

Bonleiste

473

Bonspieß

473

Brennpastenbehälter Edelstahl

350

Brezel- oder Wurstständer

84

Brotstation

88

Brotkorb

88, 93, 318-319, 326-327

Brotscneiderbrett

59, 88, 130

Brötchenschütze

215

Brötchenspender Edelstahl

93

Brottasche

320-322

Buffet Box

70

Buffet Kühlset

18, 112

Buffet-Set

93

Buffetbrett

52, 117-118, 129

Buffetgestell

93

Buffetkorb

16, 93, 314-315, 319

Buffetleiter

77, 78, 80-81, 93

Buffetschilder

20, 45, 304, 495

Buffetständer

61, 66, 69, 74-75, 91, 96-98, 118, 157, 184, 217, 287

Buffetständer Edelstahl

98

Buffetständer Holz

61, 66, 74-75, 98

Buffetständer Metall

69, 96-97, 118, 157, 184, 287

Buffetvitrine

25-28, 34

Buffetvitrine Edelstahl

25-26, 28, 34

Butterdose

270

Butterservierer

270

Bürste Bar

412

C

Caddy	126, 141, 246, 272-273, 296, 409
-------	----------------------------------

Cerealenspender

21, 59-62

Cerealenspender Edelstahl

21, 59-62

Chafing Dish

334-346

Chafing Dish Rolltop

348

Champagnerkühler

376-378

Cocktailmesser

401

D

Darioform	469
-----------	-----

Deckel

65, 77, 209-210, 214, 225, 286, 355-358, 480, 493-495

Deckel Edelstahl

355-356

Dekoriermesser

401, 458

Dip-Schälchen

196, 202, 213, 221, 223, 229, 237-239

Dispenser Saft

20, 41, 43-45

Dispenser Milch

20, 44-46

Dosier- & Vorratsflasche

411, 475-476

Dosierer Zucker

267-268, 417-418

Dosierpumpe

477

Dosierspender

477

Dressingtopf Edelstahl

73

Dressingtopf Melamin

73

Dressingtopf Porzellan

73

E

Eier-Box	368, 477
----------	----------

Eierbecher

218, 270

Eierkorb

311

Eierschneider

462

Eimer

369

Eis-Kugel-Former

404

Eisbox

405

Eiseimer

373, 405-406

Eisportionierer

474

Eisschaufel

406

Eiswaffel-Ständer

474

Eiswasserröhre

36, 52-53, 383

Eiswürfelform

404

Eiszange

407

Eiszerkleinerer

406

Emaille-Artikel

211, 270, 279-280, 287

Entkerner

457

Etagère

67-68, 82-87, 116, 186, 216

F

Fadenschneider	456
----------------	-----

Fast-Food Tablett	133
-------------------	-----

Feuerzangenbowle-Set	271, 347
----------------------	----------

Fingerfood-Löffel	200, 219-220
-------------------	--------------

Flambierbrenner	474
-----------------	-----

Flasche	52-53, 266, 281, 411, 413, 433, 475-476
---------	---

Flaschenhalter Wein	382
---------------------	-----

Flaschenkühler	54, 56, 228, 372, 375-376, 379-382, 388, 410
----------------	--

Flaschenöffner	56, 413
----------------	---------

Folien-Abreißvorrichtung	473
--------------------------	-----

Fondue-Set	271, 347
------------	----------

Frischhaltedeckel	19, 286
-------------------	---------

G

Gabel Fleisch	439, 442-443
---------------	--------------

Gabel Salat	438, 441, 454
-------------	---------------

Spitzsieb	464
-----------	-----

Gebäckpalette	459
---------------	-----

Gebäckzange	446-447, 450-451
-------------	------------------

Gemüsehobel	466
-------------	-----

Getränkenspender	36-40, 383-384
------------------	----------------

Getränkewanne	55, 377
---------------	---------

Gewürzständer	265
---------------	-----

Gewürzstreuer	258
---------------	-----

Gläsereschiene	392
----------------	-----

Glasumrandler	409
---------------	-----

Glocke	292, 426
--------	----------

Gourmetlöffel	240, 453
---------------	----------

GN Abtropfgitter	356, 358
------------------	----------

GN Behälter	100, 224-225, 353-354, 357-359, 361-363
-------------	---

GN Behälter Edelstahl	100, 353-354
-----------------------	--------------

GN Besteckbehälter

137-138, 312, 360, 367

GN Buffetgestell

316

GN Buffetleiter

80-81

GN Buffetständer

157

GN Buffetvitrine Edelstahl

25-26, 28

GN Chafing Dish

335-336, 338-339, 343-346

GN Deckel

225, 355-358, 362

GN Haube

17, 99-100, 316, 318, 348, 484-487

GN Korb

16, 309, 312-314, 324

GN Korb Metall

324

GN Korb Polypropylen

16, 309, 312-314

GN Naturschieferplatte

24, 250

GN Partyplatte

108

GN Rost

360

GN Schale Melamin

153-154, 182, 224-225

GN Servierbrett

424

GN Serviergestell

17

GN Tablett

153, 156, 159, 161, 166, 169-170, 173, 183, 185, 188, 193, 202, 204, 206-207
--

GN Tablett Edelstahl

15, 29, 99-101, 204

GN Tablett Melamin

24, 66, 153, 156, 159, 161, 166, 169-170, 173, 183, 185, 188, 193, 202, 204, 206-207
--

GN Tablett Porzellan

15, 360

GN Wanne

15, 24

Gourmetgläser

285

H

Häkelkorb	322
-----------	-----

Haube

Salatzange	445-449	Stößel	402
Salat-Löffel	441	Stövchen	58
Salzmühle	252-257, 266	Streichpalette	459
Sauciere	291-292	Streuer	257-258, 465
Schälchenspender	79	Streuer Pfeffer	257, 465
Schale Aluminium	237, 323	Streuer Salz	257-258, 465
Schale Beton	74	Superbox	21-24, 330-331
Schale Edelstahl	19, 102, 229, 232, 235-237, 327	Suppenkelle	441, 443, 445
Schale Emaille	279-280, 287	Suppentopf	337, 345-346
Schale Glas	77, 106	Sushiboard Holz	124, 247
Schale Holz	69, 119, 127-128, 241-242, 495	Sushiboard Melamin	147-148, 198
Schale Melamin	145-154, 156, 160, 162-165, 167-169, 172, 174, 176, 179, 181-186, 190-191, 194-199, 201-223, 493	T	
Schaufel Eis	406	Tablet Caddy	126, 128, 141, 246, 272-273
Schaufel Mehl	470, 481	Tablett 14-15, 24, 27, 29, 35, 72, 83, 88, 94, 99-106, 109-111, 124-125, 131-133, 144, 146-148, 153, 156, 159-161, 163, 166, 169-174, 179, 183, 185-189, 192-194, 198, 200, 202, 204, 206-207, 210, 215, 217, 360, 423, 426	
Schaumlöffel	440, 445	Tablett Edelstahl	14-15, 34-35, 99-106, 109-111, 228, 251, 293, 420-422, 426
Schaumspeisering	468	Tablett Fast Food	133, 425
Schiefer	24, 28, 87, 112-116, 120-121, 244, 249-250, 256	Tablett Holz	83, 88, 94, 107, 124-125, 132, 243, 246-247, 424
Schilder	297-299, 304, 495	Tablett Melamin	83, 88, 144, 146-148, 153, 156, 159-161, 163, 166, 169-174, 179, 183, 185-189, 192-194, 198, 200, 202, 204, 206-207, 210, 215, 217, 363
Schlüsselschnur	410	Teebox	58
Schneebesen	462	Teebrühsieb	418
Schneidbrettständer	474	Teekanne ASIA	57, 419
Schneidebrett	15, 88-89, 130, 401	Teigbehälter	368, 480
Schöpflöffel	438, 440, 442-443, 445	Teigschaber / Abstecher	461, 480
Schutzmantel	48	Teller Emaille	279
Sektkühler	55, 372-375, 377-378	Teller Fingerfood	204
Senftöpfchen	261	Teller Melamin	144, 146-148, 160, 162, 164, 175, 192, 194, 198, 204, 208, 217, 222
Servierbox	187	Thermometer	415
Serviertöpfchen	106, 232-233	Thermo Tablett-Set	35
Servier- / Tortenplatte Edelstahl	105, 135, 289	Thermo-Set	30
Servier- / Tortenplatte Holz	122, 134-135, 288-289	Tischrestehälter	295-296
Servier- / Tortenplatte Melamin	134, 216, 288	Tischaufsteller	300, 304
Servierbrett	83, 119-126, 128-129, 242-249	Tischkartenhalter	297-302
Servierfrittierkorb	114, 234	Tischkrümelentferner	292, 426
Serviergabel	438-439, 442-443, 453	Tischsets	276-278
Serviergestell	79, 84-86, 286	Tortenheber	439, 441
Servierkelle	230, 441	Tortenmesser	439
Servierkorb	234, 237	Tortenplatte	105, 115, 122, 134-135, 216, 288-289
Servierlöffel	218, 438, 440-443, 445	Tortenring	469
Servierpfanne	102, 232-233	To-Go Becher	305, 432, 497
Servierpfanne Gusseisen	231	Transportwagen	364-365
Servierset	150-151	Tretbeutelhalter	431
Serviertablett	109-111, 125, 131-132, 246, 251, 421-424	Trichter	369, 466, 471
Servierwagen	364-365	Trinkbecher	39-40, 385, 387
Servierzange	446	Trinkflasche	433
Serviettenhalter	139-141	Trinkglas	38, 386
Serviettenringe	293	Trinkhalme	408
Serviettentaschen	277	Tropfenschale Melamin	37, 39, 384
Shaker	395-396	U	
Sieb	400-401, 418, 463-464	Universalbox	65
Snackbox	126-127, 230, 243	Universalkanne	414-415
Snackholder	232-239	Untersetzer Edelstahl	293
Snackpresenter	92	Untersetzer Kork	40
Snackspender	240, 393	Untersetzer Naturschiefer	114, 250, 256
Spachtel	461	V	
Spaghettizange	445, 449	Vase	275
Spargelzange	486	Verschluss Wein / Champagner	412
Sparschäler	456	Vorspeisenzange	449
Speisenwärmer	350	Vorratsglas	63-64
Spießständer / Spieße	271	W	
Spritzflasche	266, 411	Wachspapier	111, 114, 126, 236, 251, 420
Standascher	430	Wanne	15, 368
Ständer	61, 66, 69, 74-75, 84, 96-98, 157, 179-180, 184, 216-217, 271, 287, 328, 474	Warenträger	108, 276
Ständer Wein- / Sektkühler	374	Wärme-Kies	351
Staubkappen	410		
Stielkasserolle	233		
Stift	304		

Warnschild	477, 496
Wasserbadschüssel	466
Wasserkanne	50, 52-53
Wasserspender	36-40, 383-384
Weck Gläser	65, 282-286
Weinkühler	55, 372-375, 377-378, 382
Weinkühlerständer	374
Wender	439-440, 443-444, 459-460
Windaschenbecher	427-429
Windlicht	274

Z	
Zange	407, 445-452
Ziseliermesser	456
Zitronenschnitzelpresse	418
Zitruspresse	403, 472
Zuckerdosierer	267-268, 417-418
Zuckerkuigel	267, 417
Zuckerspender	267-268, 417-418
Zutatenbehälter	401

ENGLISH

item	page
A	
adapter	354, 356
air pot	47
airtight cover	19, 286
ashtray	427-430
asparagus tongs	486
B	
baguette basket	92, 310, 316
Bain-Marie	335-336, 338-340, 343-346, 348, 466
baking mittens	478
baking pan	469, 478-479
baking sheet	111, 251, 360
bar caddy	409
bar knife	401
bar spoon	399
bar strainer	400, 464
barrel mug	39-40, 123, 218, 240, 270, 280, 305, 385, 387-396, 427-432, 434, 467-468, 497
basket metal	234, 323-325, 327-328
basket polypropylene	294, 308-319
basket stainless steel	234, 326-327
beaker	280
beer rack	131, 423
Bento Box	156-157
beverage dispenser	36-40, 383-384
beverage tub	55, 377
bill presenter	293, 426
bill rail	473
bill spike	473
bottle	52-53, 266, 281, 411, 413, 433, 475-476
bottle cooler	54, 56, 228, 372, 375-376, 379-382, 388, 410
bottle fuel	350
bottle opener	56, 413
bowl aluminium	237, 323
bowl concrete	74
bowl enamel	279-280, 287
bowl glass	77, 106
bowl holder	79
bowl melamine	145-154, 156, 160, 162-165, 167-169, 172, 174, 176, 179, 181-186, 190-191, 194-199, 201-223, 493
bowl stainless steel	19, 102, 229, 232, 235-237, 327
bowl wood	69, 119, 127-128, 241-242, 495
bread basket	320-322
bread station	88
Breadbox	88, 93, 318-319, 326-327
breeding set	472
brush	272, 281

bucket	369
buffet basket	16, 93, 314-315, 319
buffet box	70
buffet ladder	77, 78, 80-81, 93
buffet set	93
buffet signs	20, 45, 304, 495
buffet stand	61, 66, 69, 74-75, 91, 93, 96-98, 118, 157, 184, 217, 287
buffet stand metal	69, 96-97, 118, 157, 184, 287
buffet stand stainless steel	98
buffet stand wood	61, 66, 74-75, 98
Buffett-board	52, 117-118, 129
butter dish	270
butter dish	270
C	
caddy	126, 141, 246, 272-273, 296, 409
cake lifter	439, 441
cake plate melamine	134, 216, 288
cake plate stainless steel	105, 135, 289
cake plate wood	122, 134-135, 288-289
cake setting ring	469
cake slice	439
cake stand	105, 115, 122, 134-135, 216, 288-289
candle holder	274
cap bowl	56
cast iron pan	231
caviar cooler	106, 271
cereal dispenser	21, 59-62
cereal dispenser stainless steel	21, 59-62
Chafing Dish	334-346
Chafing Dish Rolltop	348
chalk marker	304
champagne bowl	55, 372-375, 376-378
cheese dish	264-265
cheese slicer	458
chefs blow torch	474
chopping board	15, 88-89, 130, 401
cleaning brush	412
clingfilm tear-off dispenser	473
cloche / dome cover	292, 426
coaster cork	40
coaster natural slate	114, 250, 256
coaster stainless steel	293
coffee cup	280, 305, 432
coffee dispenser stainless steel	47, 348
coffee pot	415
concrete	141, 168, 260, 272, 274-275, 298, 381, 384
confectionery funnel	466
conference bottle cooler	410
conical strainer	464
container	294-296, 312, 368, 401
cool collar	382
cooler	27-34, 42, 496
cooling bowl	19, 31-33
cooling box	18, 28-30, 54, 112
cooling carafe	50
cooling plates	14, 27, 29
corer	457
corkscrew	413
cornet stand	474
cover	14, 16-17, 65, 77, 94, 99-102, 104-107, 122, 136, 166, 170, 180, 209-210, 214, 217, 225, 286, 290, 316, 318, 348, 355-358, 480, 484-497
cover holder	94
cover stainless steel	355-356
crochet rope basket	322
crumber	292, 426
curler	84, 458, 466
cutlery bag	277
cutlery basket	294
cutlery dispenser	294, 317

cutlery organizer	21, 137-138, 295, 312, 366-367	GN-container	100, 224-225, 353-354, 357-359, 361-363	peeler	456	spice rack	265
cutlery rest	218, 351	GN-drainer	356, 358	pen	304	spice shaker	258
cutting board	59, 88, 130	GN-lid	225, 355-358, 362	pepper mill	252-257, 266, 465	spider spoon	465
cutting board rack	474	gourmet glasses	285	pitcher	45-50, 52-54, 57, 235, 269, 380, 414-416, 419	spoon	218-220, 240, 399, 438-445, 453, 455, 465
C		graduated jug	467-468	pizza cutter	457, 462, 480	squeeze bottle	266, 411, 475-476
Dariol moulds	469	gravy boat	291-292	pizza dish	478-480	stainless steel frame for induction plate	336-338, 349
decorating knife	401, 458	H		pizza peel	479	stand for wine / champagne bowl	374
decorator / zester	456	heating unit	47, 348-350	placemat	276-278	standing ashtray	430
delicatessen spoon	453	honey spoon	455	plate enamel	279	stirring cup	468
designation cards	298-301	hygienic cover	84, 90, 93	plate melamine	144, 146-148, 160, 162, 164, 175, 192, 194, 198, 204, 208, 217, 222	strainer	400-401, 418, 463-464
dip bowl	196, 202, 213, 221, 223, 229, 237-239	I		plate tray	292	straws	408
dispenser	477	ice ball former	404	plate warmer	350	superbox	21-24, 330-331
dispenser sugar	267-268, 417-418	ice box	405	porcelain	46, 338, 340	sushiboard melamine	147-148, 198
display plate	135, 289, 311	ice bucket	373, 405-406	pourer	368-369, 416	sushiboard wood	124, 247
display tray	251, 469	ice cream scoop	474	pourers 50-51, 260-263, 265-266, 369, 400, 411-412, 470		swivel peeler	457
dosing pump	477	ice crusher	406	pouring container	411, 475-476	T	
dough container	368, 480	ice cube cooling tube	36, 52-53, 383	pretzel-/ sausage stand	84	table caddy	126, 128, 141, 246, 272-273
dough scraper	461, 480	ice cube maker	404	protective coat	48	table garbage bin	295-296
dressing pot melamine	73	ice scoop	406	R		table stands	297-302, 304
dressing pot porcelain	73	ice tong	407	refrigerated buffet display	18, 112	tea-box	58
dressing pot stainless steel	73	induction plate	76, 334, 336-338, 340-341, 349	reusable cup	305, 432, 497	teapot ASIA	57, 419
dressing/sauce spoon	441, 453, 481	insulated dispenser	41	ring bell	426	teapot warmer	58
drinking bottle	433	J		roll / bun basket	215	thermo set	30
drinking cups	38-40, 385-387	jigger	397, 398	roll dispenser stainless	93	thermo tray	35
drip mat	39, 389	jug	414-415	rolltop cover	16-17, 25-30, 102, 112, 129, 217, 315, 348, 487	thermometer	415
drip tray melamine	37, 39, 404	juice dispenser	20, 41, 43-45	rolltop set	30, 106, 115	To-Go cup	305, 432, 497
dust & fly cap	410	juice pitcher	50, 52-53	rolltop-cover stainless steel	348	tray	14-15, 24, 27, 29, 35, 67-68, 72, 82-88, 94, 99-106, 109-111, 116, 124-125, 131-133, 144, 146-148, 153, 156, 159-161, 163, 166, 169-174, 179, 183, 185-189, 192-194, 198, 200, 202, 204, 206-207, 210, 215-217, 246, 251, 360, 421-424, 426
E		K		S		tray melamine	83, 88, 144, 146-148, 153, 156, 159-161, 163, 166, 169-174, 179, 183, 185-189, 192-194, 198, 200, 202, 204, 206-207, 210, 215-217, 246, 251, 360, 421-424, 426
egg basket	311	key cord	410	salad fork	438, 441, 454	tray stainless steel	14-15, 34-35, 99-106, 109-111, 228, 251, 293, 420-422, 426
egg cutter	462	L		salad spoon	218, 438, 441, 454	tray wood	83, 88, 94, 107, 124-125, 132, 243, 246-247, 424
egg holder	218, 270	labeling labels	304	salad spoon + fork	438, 454	trolley	365
eggs box	368, 477	labels	297-299, 304, 495	salad tong	445-449	turner	439, 444
enamel articles	211, 270, 279-280, 287	ladle	438, 440, 442-443, 445	salt mill	252-258, 266, 465	tweezer	407, 452
F		leaf melamine	176, 217, 490	sandwich knife	461	U	
fingerfood plate	204	lime press	403, 472	sauté pan / mini sauce pan	233	universal box	65
fire punch bowl set	271, 347	lobster cracker	462	scoop	248, 454-455	V	
flower vase	275	lunch bag	322, 434	scoop flour	470, 481	vacuum jug	47-49
fondue set	271, 347	lunchbox	329, 435	scraper	461	W	
fork	438-439, 442-443, 453	M		service trolley	364-365	waiter's corkscrew	413
free flow pourer	412	magnetic knife rack	473	serving basket	234, 237	whisk	462
fry baskets	114, 234	mandolin	466	serving board	83, 119-126, 128-129, 242-249	winebottle-stand	382
fry dripping tray	465	mandolin	466	serving box	187	woodbox	128, 246, 272-273
funnel	369, 466, 471	meatfork	439, 442-443	serving cup	232-239		
G		melon baller	456	serving set	150-151		
glass carafe	50-53	menage	256, 259-266	serving spoon	218, 438, 440-443, 445		
glass rack	392	milk dispenser	20, 44-46, 235, 269, 414-416	serving stand	61, 66, 69, 74-75, 79, 84-86, 96-98, 157, 179-180, 184, 216-217, 271, 286-287, 328, 474		
glass rimmer	409	milk jug	235, 269	skimmer	440, 445		
GN basket	16, 309, 312-314, 324	mini bowl	212, 220-221, 232-233, 235, 257, 269, 394, 416, 411	skimmer spoon	465		
GN basket metal	324	mixing glass	411	slate	24, 28, 87, 112-116, 120-121, 249-250, 256		
GN basket polypropylene	16, 309, 312-314	Moscow Mule barrel mug	388-390	small serving pot	106, 232-233		
GN bowl melamine	153-154, 182, 224-225	mousse ring	468	snack dispenser	240, 393		
GN buffet display stainless steel	25-26, 28	muddler	402	snack tray	133, 425		
GN buffet ladder	80-81	multi rack stainless steel	95	snackbox	126-127, 230, 243		
GN buffet stand	157, 316	multibox	58	snackpresenter	92		
GN Chafing Dish	335-336, 338-339, 343-346	mussel pot	287	snap mesh tea ball	418		
GN cover	17, 99-100, 316, 318, 348, 484-487	mustard glass	261	soup ladle	441, 443, 445		
GN cutlery organizer	137-138, 312, 360, 367	N		soup pot	337, 345-346		
GN grid	360	napkin bag	277	spaghetti spoon	440		
GN natural slate tray	24, 250	napkin holder	139-141	spaghetti tong	445, 449		
GN pan stainless steel	100, 353-354	napkin rings	293	spatula	459		
GN partytray	108	natural slate tray	24, 87, 112-116, 120-121, 249-250, 256				
GN serving board	424	non slip mat	36, 383				
GN serving stand	17	oyster knife	458				
GN tray	15, 24, 153, 156, 159, 161, 166, 169-170, 173, 183, 185, 188, 193, 202, 204, 206-207	P					
GN tray melamine	24, 66, 153, 156, 159, 161, 166, 169-170, 173, 183, 185, 188, 193, 202, 204, 206-207	palm leaf melamine	176, 190, 214				
GN tray porcelain	15, 360	pan	102, 231-233				
GN tray stainless steel	15, 29, 99-101, 204	pan	102, 232-233				
		party spoon	200, 219-220, 240, 453				
		partytray	108				
		pastry spatula	459				
		pastry tongs	446-447, 450-451				
		pedal bin	431				

artículos **pág.**

A	
abridor	56, 413
adaptador	354, 356
aro anti-goteo melamina	37, 39, 384
aro de tarta	469
aro redondo para semifríos	468
artículos esmaltados	211, 270, 279-280, 287
azucarero	267-268, 417-418
B	
bajo plato	292
bandeja	14-15, 24, 27, 29, 35, 72, 83, 88, 94, 99-106, 109-111, 124-125, 131-133, 144, 146-148, 153, 156, 159-161, 163, 166, 169-174, 179, 183, 185-189, 192-194, 198, 200, 202, 204, 206-207, 210, 215, 217, 246, 251, 360, 421-423, 426
bandeja acero inoxidable	14-15, 34-35, 99-106, 109-111, 228, 251, 293, 420-422, 426
bandeja autoservicio y snacks	133
bandeja autoservicio y snacks	133, 425
bandeja con alturas	67-68, 82-87, 116, 186, 216
bandeja de pizarra natural	24, 87, 112-116, 120-121, 249-250, 256
bandeja isotérmica	30
bandeja madera	83, 88, 94, 107, 124-125, 132, 243, 246-247, 424
bandeja para sushi de madera	124, 247
bandeja para sushi melamina	147-148, 198
bandeja pastelera	251, 469
bandeja tartas acero inoxidable	105, 135, 289
bandeja tartas madera	122, 134-135, 288-289
bandeja tartas melamina	134, 216, 288
bandeja termo	35
bandejas refrigeradas	14, 27, 29
baño María	335-336, 338-340, 343-346, 348, 466
barra magnética para cuchillos	473
barreño botellines	55, 377
Bento Box	156-157
bolsa cubiertos	277
bolsa de almuerzo	322, 434
bolsa de servilletas	277
bomba dosificadora	477
bote	63-64
bote dosificador flexible	475-476
bote vertedor universal	368-369, 416
botella	52-53, 266, 281, 411, 413, 433, 475-476
botella de combustible líquido	350
botella exprimible	266, 411
botes especieros	258
brocha	272, 281
C	
caballetes buffet	20, 45, 304, 495
caballetes de mesa	300, 304
cacerola	102, 231-233
caddy de mesa	126, 128, 141, 246, 272-273
cafetera	415
caja comida	187
caja de buffet	70
caja de pan para buffet	88, 93, 318-319, 326-327
caja dispensadora	65
caja madera	128, 246, 272-273
caja para huevos	368, 477
caja para té	58
calentador de tetera	58
campana	14, 16-17, 94, 99-102, 104-107, 122, 136, 166, 170, 180, 217, 290, 316, 318, 348, 484-497
campana esférica	292, 426
campana rolltop	16-17, 25-30, 102, 112, 129, 217, 315, 348, 487
campana rolltop acero inoxidable	348
candelabro	274
cantimplora	433
carro	365
carro de servicio	360, 364-365
cazo recto bajo	233
cenicero	427-429
cenicero de pie	430
cepillo de limpieza	412
cesta acero inoxidable	234, 326-327
cesta de baguette	92, 310, 316
cesta de buffet	16, 93, 314-315, 319
cesta de cuerda de ganchillo	322
cesta de huevos	311
cesta metal	234, 323-325, 327-328
cesta para bollos	215
cesta para servir	234, 237
cesta polipropileno	294, 308-319
Chafing Dish	334-346
Chafing Dish Rolltop	348
champañera	376-378
coctelera	395-396
colador	400-401, 418, 463-464
colador cónico	464
colador de cóctel	400, 464
conjunto aperitivo	256, 259-266
corta huevos	462
corta pasta	461, 480
cortador de pizza	457, 462, 480
cubeta	15, 368
cubierta higiénica antialiento	84, 90, 93
cubitera	405
cubitera isotérmica	373, 405-406
cubitera para cava	55, 372-375, 377-378
cubitera para vino	55, 372-375, 377-378, 382
cubo	369
cuchara	218-220, 240, 399, 438-445, 453, 455, 465
cuchara de espaguetis	440
cuchara de miel	455
cuchara gourmet	240, 253
cuchara para ensalada	218, 438, 441, 454
cuchara para helado	474
cuchara para hornear	465
cuchara para servir	218, 438, 440-443, 445
cuchara party	200, 219-220
cucharilla de cóctel	399
cucharón	438, 440, 442-443, 445
cucharón de salsa/aliño	441, 453, 481
cucharón de sopa	441, 443, 445
cuchillo acanalador	401, 458
cuchillo de decoración cincelador	456
cuchillo para cóctel	401
cuchillo para untar	461
cuenco acero inoxidable	19, 102, 229, 232, 235-237, 327
cuenco aluminio	237, 323
cuenco de vidrio	77, 106
cuenco esmaltado	279-280, 287
cuenco hormigón	74
cuenco melamina	145-154, 156, 160, 162-165, 167-169, 172, 174, 176, 179, 181-186, 190-191, 194-199, 201-223, 493
cuenco mini	212, 220-221, 232-233, 235, 257, 269, 394, 416,
cuenco para chapas	56
cuenco para dip	196, 202, 213, 221, 223, 229, 237-239
D	
descorazonador	457
dispensador buffet en escalera	77, 78, 80-81, 93
dispensador de bebidas	36-40, 383-384
dispensador de bocadillos	92
dispensador de cereales	21, 59-62
dispensador de cereales acero inoxidable	21, 59-62
dispensador de film	473
dispensador de leche	20, 44-46, 235, 269, 414-416
dispensador de snacks	240, 393
dispensador de zumo	20, 41, 43-45
dispensador en escalera acero inoxidable	95
dispensador isotérmico	41
E	
embudo	369, 466, 471
embudo dosificador	466
enfriador de caviar	106, 271
enfriador múltiple	410
escurridor de fritos	465
espátula	439-440, 443-444, 459-460
espátula plancha	461
especiero	265
espumadera	440, 445
espumadera para fritos	465
estación de empanado	472
estación pan	88
esterilla antideslizante	36, 383
esterilla escurridora	409
etiquetas	297-299, 304, 495
expositor	108, 276
expositor buffet	93
expositor buffet frío	18, 28-30, 54, 112
expositor de buffet	61, 66, 69, 74-75, 91, 96-98, 118, 157, 184, 217, 287
expositor de buffet acero inoxidable	98
expositor de buffet madera	61, 66, 74-75, 98
expositor de buffet metal	69, 96-97, 118, 157, 184, 287
expositor para tartas	135, 289, 311
exprimidor cítricos	403, 472
F	
fiambreira	329, 435
flaneras	469
florero	275
fuelle en forma de hoja de palmera	
melamina	176, 190, 214
fuelle en forma de hoja melamina	176, 217, 490
fuelle para la mesa	102, 232-233
funda de frío	382
funda protectora	48
G	
GN bandeja	153, 156, 159, 161, 166, 169-170, 173, 183, 185, 188, 193, 202, 204, 206-207
GN bandeja acero inoxidable	15, 29, 99-101, 204
GN bandeja de pizarra natural	24, 250
GN bandeja melamina	24, 66, 153, 156, 159, 161, 166, 169-170, 173, 183, 185, 188, 193, 202, 204, 206-207
GN bandeja party	108
GN bandeja porcelana	15, 360
GN campana	17, 99-100, 316, 318, 348, 484-487
GN cesta	16, 309, 312-314, 324
GN cesta metal	324
GN cesta polipropileno	16, 309, 312-314
GN Chafing Dish	335-336, 338-339, 343-346
GN cubeta	15, 24
GN cubeta acero inoxidable	100, 353-354
GN cuenco melamina	153-154, 182, 224-225
GN dispensador buffet en escalera	80-81
GN escurridor	356, 358
GN expositor buffet acero inoxidable	25-28

GN porta cubiertos	137-138, 312, 360, 367
GN rejilla	360
GN soporte buffet	17, 316
GN soporte para buffet	157
GN tapa	225, 355-358, 362
granulado térmico	351
H	
hormigón	141, 168, 260, 272, 274-275, 298, 381, 384
huevo	218, 270
I	
infusor de té, pinza con malla	418
J	
jarra	45-50, 52-54, 57, 235, 269, 380, 414-416, 419
jarra de agua	50, 52-53
jarra de leche	235, 269
jarra de vidrio	50-53
jarra de zumo	50, 52-53
jarra enfriadora	50
jarra graduada	467-468
jarra termo	47-49
juego de cucharas medidoras	451
L	
llavero enrollable	410
M	
mandolina	466
manoplas de panadero	478
mantelín	276-278
mantequera	270
mantequillera	270
marco de acero inoxidable para placa de inducción	336-338, 349
marco pastelero	469, 478-479
marmita	337, 345-346
medidor jigger	397, 398
mejillonera	287
molde de cubitos de hielo esféricos	404
molde de pizza	478-480
molde para cubitos de hielo	404
molinillo de pimienta	252-258, 266, 465
molinillo de sal	252-258, 266, 465
mortero	402
Moscow Mule taza	388-390
O	
organizador de bar	409
P	
pajas	408
pala	248, 454-455
pala de hielo	406
pala de pizza	479
pala de tartas	439, 441
pala para harina	470, 481
paleta para servir	230, 441
paleta pastelera	459
panera	320-322
papel alimenticio	111, 114, 126, 236, 251, 420
papelera de sobremesa	295-296
pelador reversible	457
picadora de hielo	406
pie porta champañera / vino	374
pie porta vino	374
pinchanotas	473
pinza	407, 445-452
pinza bogavante	462
pinza de emplatar	407, 452
pinza ensalada	445-449
pinza exprime limón	418
pinza para aperitivos	449
pinza para cubitos de hielo	407
pinza para pasteles	446-447, 450-451
pinza universal	446
pizarra	24, 28, 87, 112-116, 120-121, 244, 249-250, 256

placa de inducción	76, 334, 336-338, 340-341, 349	tapa hermética	19, 286
plato esmaltado	279	tapete escurridor	409
plato melamina	144, 146-148, 160, 162, 164, 175, 192, 194, 198, 204, 208, 217, 222	tapón antipolvo	410
plato para el aperitivo	204	tapón vertedor	412
polvoreador	257-258, 465	tartijas	298-301
porcelana	46, 338, 340	tarros gourmet	285
porcionador de pastel	439	taza	39-40, 123, 218, 240, 270, 280, 305, 385, 387-396, 427-432, 434, 467-468, 497
porta cubiertos	21, 137-138, 295, 312, 366-367	taza de café	280, 305, 432
porta cubiertos	294, 317	tenedor de carne	439, 442-443
porta cuenta	293, 426	tenedor de ensalada	438, 441, 454
porta menú	297-302	termómetro	415
porta vasos de cerveza	131, 423	tetera ASIA	57, 419
portafichas	473	timbre	426
porta-tartijas	297-302	tubo enfriador para cubitos	36, 52-53, 383
portavelas antiviento	274	V	
posavasos acero inoxidable	293	vaciador de melón redondo	456
posavasos pizarra natural	114, 250, 256	vaso	38, 386
prensa de limón	403, 472	vaso agitador	468
R		vaso coctelero	280
rack de copas	392	vaso mezclador vertedor	411
rack dispensador de cuencos	79	vaso para servir	232-239
rebanador de queso	458	vaso reutilizable	305, 432, 497
recipiente de ingredientes	401	vaso To-Go	305, 432, 497
recipiente organizador	294-296, 312, 368, 401	vasos	39-40, 385, 387
recipiente para masa	368, 480	vertedor continuo	412
recogemigas	292, 426	vertedores	50-51, 260-263, 265-266, 369, 400, 411-412, 470
reposa cuchara	218, 351	vitrina de buffet	25-28, 34
resistencia	47, 348-350	vitrina de buffet acero inoxidable	25-26, 28, 34
ribeteador de vasos	409	W	
rizador	84, 458, 466	Weck-botellas	65, 282-286
rotulador de tiza	304		
S			
sacacorchos	413		
sacacorchos de camarero	413		
salsera	291-292		
salsera acero inoxidable	73		
salsera melamina	73		
salsera porcelana	73		
sartén de hierro fundido	231		
Servidor de ensalada	438, 454		
servilletero	139-141		
servilleteros/aros	293		
set de buffet	93		
set de buffet refrigerado	18, 112		
set para fondue	271, 347		
set para servir	150-151		
set rolltop	30, 106, 115		
snackbox	126-127, 230, 243		
soplete de cocina para flambeo	474		
soporte	61, 66, 69, 74-75, 84, 96-98, 157, 179-180, 184, 216-217, 271, 287, 328, 474		
soporte a pedal	431		
soporte campana	94		
soporte cucurucho	474		
soporte de pretzels o salchichas	84		
soporte para botella de vino	382		
soporte para brochetas	371		
soporte para pastel	105, 115, 122, 134-135, 216, 288-289		
soporte para tablas de cortar	474		
soporte platos	79, 84-86, 286		
superbox	21-24, 330-331		
T			
tabla de corte	59, 88, 130		
tabla de servir	83, 119-126, 128-129, 242-249		
tabla para cortar	15, 88-89, 130, 401		
tabla para el buffet	52, 117-118, 129		
tapa	65, 77, 209-210, 214, 225, 286, 355-358, 480, 493-495		
tapa acero inoxidable	355-356		

FRANÇAIS

item	pág.
A	
accumulateur de froid	27-34, 42, 496
adaptateur	354, 356
anneaux à serviettes	293
ardoise	24, 28, 87, 112-116, 120-121, 244, 249-250, 256
articles en email	211, 270, 279-280, 287
assiette de présentation	292
assiette email	279
assiette mélamine	144, 146-148, 160, 162, 164, 175, 192, 194, 198, 204, 208, 217, 222
assiette pour apéritif	204
B	
Bain-Marie	335-336, 338-340, 343-346, 348, 466
barre aimantée pour couteaux	473
barre porte-bons	473
base bois	128, 246, 272-273
bassine à glace	55, 377
Bento Box	156-157
béton	141, 168, 260, 272, 274-275, 298, 381, 384
beurrer	270
boîte à lunch	329, 435
boîte à œufs	368, 477
boîte à pain pour le buffet	88, 93, 318-319, 326-327
boîte à thés et infusions	58
boîte de buffet	70
boîte-repas	187
bol acier inox	19, 102, 229, 232, 235-237, 327
bol aluminium	237, 323
bol béton	74
bol bois	69, 119, 127-128, 241-242, 495
bol email	279-280, 287
bol en verre	77, 106
bol mélamine	145-154, 156, 160, 162-165, 167-169, 172, 174, 176, 179, 181-186, 190-191, 194-199, 201-223, 493
bol mélangeur	280
bol mini	212, 220-221, 232-233, 235, 257, 269, 394, 416,
bol récupérateur de capsules	56
bol réfrigéré	19, 31-33
bordeur à verres	409
bouchon anti-poussières et anti-insectes	410
bouchons verseurs	50-51, 260-263, 265-266, 369, 400, 411-412, 470
boule à thé avec pince	418
bouteille	52-53, 266, 281, 411, 413, 433, 475-476
bouteille store & pour	411, 475-476
bouteille de combustible liquide	350
bouteille isotherme	47-49
bouteille verseuse souple	475-476
brosse lave	412
broyeur à glaçons	406
C	
caddy	126, 141, 246, 272-273, 296, 409
caddy de table	126, 128, 141, 246, 272-273
cadre support inox pour plaque induction	336-338, 349
caisson thermo	35
carafe en verre	50-53
casserole	102, 231-233
casserole à moules	287
cendrier	427-430
cendrier sur pied	430
cercle à gâteaux	469
cercle à mousse rond	468
Chafing Dish	334-346
Chafing Dish Rolltop	348
chalumbeau e cuisine	474
chandelier	274
chariot	365
chariot de service	360, 364-365
chauffe-plat	350
chauffe-théière	58
chevalets de table	300, 304
chinois	464
cloche	14, 16-17, 94, 99-102, 104-107, 122, 136, 166, 170, 180, 217, 290, 316, 318, 348, 484-497
cloche demi-sphère	292, 426
cloche rolltop	16-17, 25-30, 102, 112, 129, 217, 315, 348, 487
cloche rolltop acier inox	348
coquetier	218, 270
corbeille	320-322
corbeille à baquette	92, 310, 316
corbeille à petits pains	215
corbeille acier inox	234, 326-327
corbeille de buffet	16, 93, 314-315, 319
corbeille de service	234, 237
corbeille métal	234, 323-325, 327-328
corbeille polypropylène	294, 308-319
coupe-œufs	462
coupe-pâte	461, 480
coupe-pizza	457, 462, 480
couteau à huitres	458
couteau à tarte	439
couteau à tartiner	461
couteau cannelé	401, 458
couteau cocktail	401
couteau tranche-fromage	458
couteau zesteur	456
couvercle	65, 77, 209-210, 214, 225, 286, 355-358, 480, 493-495
couvercle acier inox	355-356
couvercle hermétique	19, 286
couvert à salade	438, 454
cuillère	218-220, 240, 399, 438-445, 453, 455, 465
cuillère à cocktail	399
cuillère à glace	474
cuillère à miel	455
cuillère à salade	218, 438, 441, 454
cuillère à sauce	441, 453, 481
cuillère à spaghettis	440
cuillère de service	218, 438, 440-443, 445
cuillère gourmet	240, 453
cuillère party	200, 219-220
cuillère party	2000, 219-220
cuillère pâtisserie	465
D	
décapsulateur	56, 413
dénoyauteur	457
dérouleur de film	473
distributeur de petits pains acier inox	93
distributeur à jus	20, 41, 43-45
distributeur à lait	20, 44-46, 235, 269, 414-416
distributeur de boisson isothermique	41
distributeur de boissons	36-40, 383-384
distributeur de café acier inox	47, 348
distributeur de céréales	21, 59-62
distributeur de céréales acero inox	21, 59-62
distributeur de snacks	240, 393
doseur à sauce	477
E	
écumoire	440, 445
égouttoir à friture	465
entonnoir à piston	466
étagère	67-68, 82-87, 116, 186, 216
étiquettes	297-301, 304, 495
F	
flacon pulvérisateur	266, 411

forme à gateaux	469, 478-479	pelle à gâteaux	439, 441	pot à épices	257-258, 465	tapis égouttoir	409
fouet	462	pelle à glaçons	406	pot à sauce acier inox	73	tasse à café	280, 305, 432
fourchette à salade	438, 441, 454	pelle à pizza	479	pot à sauce mélamine	73	tasse à remuer	468
fourchette à viande	439, 442-443	petits chevaux de buffet	20, 45, 304, 495	pot à sauce porcelaine	73	tasse réutilisable	305, 432, 497
fourchette de service	438-439, 442-443, 453	pichet	45-50, 52-54, 57, 235, 269, 380, 414-416, 419	pot de moutarde	261	tasse To-Go	305, 432, 497
frisette	84, 458, 466	pichet à café	415	pot verseur universel	368-369, 416	théière ASIA	57, 419
G		pichet à jus de fruit	50, 52-53	poubelle de table	295-296	thermomètre	415
gants de boulanger	478	pichet à lait	235, 269	présentoir à assiettes	79, 84-86, 286	tire-bouchons	413
GN bac	15, 24, 100, 224-225, 353-354, 357-359, 361-363	pichet gradué	467-468	présentoir à gâteaux	105, 115, 122, 134-135, 216, 288-289, 311	truille de service	230, 441
GN bac acier inoxydable	100, 353-354	pichet rafraîchisseur	50	présentoir à sandwiches	92	tube pour glaçons	36, 52-53, 383
GN bol mélamine	153-154, 182, 224-225	pied pour seau à champagne / vin	374	présentoir buffet	61, 66, 69, 74-75, 91, 93, 96-98, 118, 157, 184, 217, 287	V	
GN Chafing Dish	335-336, 338-339, 343-346	pilon muddler	402	présentoir buffet acier inox	98	verre mélangeur	411
GN cloche	17, 99-100, 316, 318, 348, 484-487	pince à asperges	486	présentoir buffet bois	61, 66, 74-75, 98	verres gourmet	285
GN corbeille	16, 309, 312-314, 324	pince à dresser	407, 452	présentoir buffet en escalier	77, 78, 80-81, 93	verseurs continus	412
GN corbeille métal	324	pince à gâteaux	446-447, 450-451			vitrine de buffet	25-28, 34
GN corbeille polypropylène	16, 309, 312-314	pince à glaçons	407			vitrine de buffet acier inox	25-26, 28, 34
GN couvercle	225, 355-358, 362	pince à homard	462				
GN égouttoir	356, 358	pince à salade	445-449				
GN grille	360	pince à spaghetti	445, 449				
GN planche de service	424	pince universelle	446				
GN plateau	153, 156, 159, 161, 166, 169-170, 173, 183, 185, 188, 193, 202, 204, 206-207	pinceau pâtissier	272, 281				
GN plateau acier inox	15, 29, 99-101, 204	pique-bons	473				
GN plateau ardoise naturelle	24, 250	planche à découper	15, 59, 88-89, 130, 401				
GN plateau buffet acier inox	25-26, 28	planche à découper buffet	52, 117-118, 129				
GN plateau mélamine	24, 66, 153, 156, 159, 161, 166, 169-170, 173, 183, 185, 188, 193, 202, 204, 206-207	planche de service	83, 119-126, 128-129, 242-249				
GN plateau party	108	plaque à induction	76, 334, 336-338, 340-341, 349				
GN plateau porcelaine	15, 360	plaque à pâtisserie	251, 469				
GN présentoir buffet	157, 316	plaque à pâtisserie	111, 251, 360				
GN présentoir buffet en escalier	80-81	plat à gâteau acier inox	105, 135, 289				
GN range couverts	137-138, 312, 360, 367	plat à gâteau bois	122, 134-135, 288-289				
GN support buffet	17	plat à gâteau mélamine	134, 216, 288				
gobelet	39-40, 123, 218, 240, 270, 280, 305, 385, 387-396, 427-432, 434, 467-468, 497	plat à sauter	233				
gobelet à apéritif	232-239	plat ardoise naturelle	24, 87, 112-116, 120-121, 249-250, 256				
H		plat pour la table	102, 232-233				
housse de protection	48	plateau	14-15, 24, 27, 29, 35, 72, 83, 88, 94, 99-106, 109-111, 124-125, 131-133, 144, 146-148, 153, 156, 159-161, 163, 166, 169-174, 179, 183, 185-189, 192-194, 198, 200, 202, 204, 206-207, 210, 215, 217, 246, 251, 360, 421-424, 426				
housse isotherme	382	plateau acier inox	14-15, 34-35, 99-106, 109-111, 228, 251, 293, 420-422, 426				
J		plateau bois	83, 88, 94, 107, 124-125, 132, 243, 246-247, 424				
jeu de cuillère à mesure	451	plateau feuille de palme mélamine	176, 190, 214				
L		plateau feuille mélamine	176, 217, 490				
louche	438, 440, 442-443, 445	plateau mélamine	83, 88, 144, 146-148, 153, 156, 159-161, 163, 166, 169-174, 179, 183, 185-189, 192-194, 198, 200, 202, 204, 206-207, 210, 215, 217, 363				
louche de service	441, 443, 445	plateau party	108				
M		plateau self-service et snacks	133, 425				
mandoline	466	plateau sushi en bois	124, 247				
marmite	337, 345-346	plateau sushi mélamine	147-148, 198				
marmite petite de servir	106, 232-233	plateaux réfrigérés	14, 27, 29				
marqueur à la craie liquide	304	plucheur droitier/gaucher	457				
mesure jigger	397, 398	pochette à serviettes	277				
Moscow Mule gobelet	388-390	pochette couverts	277				
moule à boule ronde simple	456	poêle en fonte	231				
moule à glaçons	404	pompe de dosage	477				
moule à glaçons en boules	404	porcelaine	46, 338, 340				
moule à pizza	478-480	porte verres à bière	131, 423				
moules à flan	469	porte-addition	293, 426				
moulin à poivre	252-257, 266, 465	porte-bols	79				
moulin à sel	252-258, 266, 465	porte-bouteille à vin	382				
multibox	58	porte-cartes	297-302				
N		porte-clés avec câble à enroulement	410				
organisateur bar caddy	409	porte-épices	265				
P		porte-épices	265				
panier à œufs	311	porte-serviettes	139-141				
panier en corde au crochet	322	pose-cuillère	218, 351				
panier pour le service sur table	114, 234						
pare-haleine	84, 90, 93						
passoire	463-464						
peleur	456						
pelle	248, 454-455						
pelle à farine	470, 481						





Buffet & Display

FRAMES	14
BRIDGE	18
SUPERBOX	22
COOLING DISPLAYS	25
BEVERAGE DISPENSERS	36
VACUUM JUGS	48
CARAFES	50
BEVERAGE BOWLS	54
TEAPOTS	57
CEREAL DISPENSERS	59
CANISTERS	63
BUFFET DISPLAY	66
ETAGERES	82
CUTTING BOARDS	88
BUFFET GUARDS SHOWCASES	90
MULTI RACKS	95
BUFFET STANDS	96
TRAYS BOARDS	99
SERVING BOARDS NATURAL SLATE	112
SERVING BOARDS WOOD	117
TRAYS	131
FAST FOOD TRAYS	133
CAKE STANDS	134
SUPER DOME	136
CUTLERY BOXES	137
NAPKIN HOLDERS	139

FRAMES



Die reduzierte, archetypische Formsprache von FRAMES nimmt sich elegant zurück und lässt damit viel Raum für die Inszenierung der Buffet-Speisen. Ein scheinbarer Widerspruch löst sich auf: das Design ist zeitgemäß und zeitlos zugleich.

Design in detail – The classic minimalist visual style of FRAMES is elegantly understated, leaving plenty of potential for creating appealing buffet arrangements. Its design transcends what at first seems to be an irreconcilable paradox, being at once both timeless and highly contemporary.

Diseño en detalle - El estilo visual clásico y minimalista de FRAMES es elegantemente sobrio, dejando mucho potencial para crear atractivas composiciones para el buffet. Su diseño supera lo que a primera vista parece una paradoja irreconciliable, siendo a la vez intemporal y muy contemporáneo.

Le design dans le détail - Le style visuel minimaliste classique de FRAMES est élégamment discret, laissant beaucoup de potentiel pour créer des arrangements de buffet attrayants. Son design transcende ce qui semble à première vue être un paradoxe irréconciliable, étant à la fois intemporel et très contemporain.



Kühltablets SET 1 „FRAMES“

cooling plates
bandejas refrigeradas
plateaux réfrigérés



GN 1/1 Basiselement, GN 1/1 Edelfstahl Tablett 18/10, Kühlakku

GN 1/1 base element, GN 1/1 stainless steel platter 18/10, cooler
elemento básico GN 1/1, bandeja GN 1/1 de acero inoxidable 18/10, acumulador de frío
élément de base GN 1/1, plateau GN 1/1 en acier inox 18/10, accumulateur de froid

	cm	↑ cm	GN	Farbe / Colour		€
12940	53 x 32,5	8,5	1/1	stainless steel		246,00
14940	53 x 32,5	8,5	1/1	wenge wood		249,00
13940	53 x 32,5	8,5	1/1	maple wood		249,00



Kühltablets SET 2 „FRAMES“

cooling plates
bandejas refrigeradas
plateaux réfrigérés



GN 1/1 Basiselement, GN 1/1 Edelfstahl Tablett 18/10, Rolltophaube, Kühlakku

GN 1/1 base element, GN 1/1 stainless steel platter, rolltop cover, cooler
elemento básico GN 1/1, bandeja GN 1/1 de acero inoxidable 18/10, campana rolltop, acumulador de frío
élément de base GN 1/1, plateau GN 1/1 en acier inox 18/10, cloche rolltop, accumulateur de froid

	cm	↑ cm	GN	Farbe / Colour		€
12941	53 x 32,5	27,5	1/1	stainless steel		310,00
14941	53 x 32,5	27,5	1/1	wenge wood		314,00
13941	53 x 32,5	27,5	1/1	maple wood		314,00



Schneidebrett „FRAMES“

cutting board
tabla de cortar
planche à découper

Ahorn, massiv
maple wood, solid
madera de arce, maciza
bois d'érable, massif



	cm	↑ cm	GN	€
13955	53 x 32,5	2,5	1/1	58,00



Schneidebrett „FRAMES“

cutting board
tabla de cortar
planche à découper



	cm	↑ cm	GN	€
17910	53 x 32,5	2,5	1/1	63,00



82355
GN 1/1

GN Tablett „FRAMES“

GN tray
GN bandeja
GN plateau



	cm	↑ cm	GN	€
82355	53,0 x 32,5	2	1/1	46,00
82356	32,5 x 26,5	2	1/2	26,00
82357	32,5 x 17,6	2	1/3	22,00



11119

11118

GN Edelstahl Tablett „FRAMES“

GN stainless steel platter
GN bandeja acero inoxidable
GN plateau acier inox



	cm	↑ cm	GN	€
11119	53,0 x 32,5	2	1/1	33,00
11118	32,5 x 26,5	2	1/2	18,40



84046

GN Tablett „FRAMES“

GN tray
GN bandeja
GN plateau



	cm	↑ cm	GN	€
84046	53,0 x 32,5	2	1/1	33,00
84047	32,5 x 26,5	2	1/2	18,40
84048	32,5 x 17,6	2	1/3	12,60



GN Wanne „FRAMES“

GN tray
GN bandeja
GN plateau



	cm	↑ cm	GN	€
17922	53 x 32,5	8	1/1	60,00

FRAMES



Korb „GN LINE“

GN basket

GN cesta

GN corbeille



stabile Ausführung mit Edelstahldraht im Rand zur Stabilisierung

very solid with stainless steel wire frame to stabilize the basket

muy resistente con alambre de acero inoxidable en el borde para la estabilización

très résistante avec fil d'acier inox dans le bord pour la stabilisation

	cm	↑ cm	GN	€
40291	53,0 x 32,5	6,5	1/1	26,00
40290	32,5 x 26,5	6,5	1/2	15,80
40293	53,0 x 32,5	10,0	1/1	31,40
40292	32,5 x 26,5	10,0	1/2	18,80



Buffetkorb „ECONOMIC“

basket

cesta

corbeille



Polyrattan, mit Haubenschiene (ohne Haube)

polyrattan, with frame to fix the cover (without cover)

polyrattan, con fijación para campana (sin campana)

polyrattan, avec fixation pour la cloche (sans cloche)

	cm	↑ cm	€
40294	56,5 x 36,0	10	33,00



Buffetkorb „ECONOMIC“

buffet basket

cesta de buffet

corbeille de buffet



Polyrattan, mit Haubenschiene (ohne Haube)

polyrattan, with frame to fix the cover (without cover)

polyrattan, con fijación para campana (sin campana)

polyrattan, avec fixation pour la cloche (sans cloche)

	Ø cm	↑ cm	€
40295	40	12,5	23,00



Rolltophaube

rolltop cover

campana abatible

cloche basculante



	Ø cm	↑ cm	€
18389	38	20	23,00



Eisbox „FRAMES“

ice box

bandeja para hielo

caisse à glaçons



3-teilig: 1 Basiselement Wenge + 1 Polystyrolwanne + 1 Tropfmitter

3 pcs. set: 1 box wenge + 1 plastic deep tray + 1 drainer plate

set de 3: 1 cajón color wengué + 1 cubeta plástico + 1 rejilla

set de 3: 1 caisson couleur wengé + 1 bac plastique + 1 plaque perforée

	cm	↑ cm	GN	Farbe / Colour	€
14970	53 x 32,5	12,5	1/1		189,00



vielseitig einsetzbar für alle GN 1/1 Artikel



11008
2x 85146
GN 1/2

passendes Kühltablett Set

Gestell für GN 1/1 „FRAMES“

serving stand GN 1/1
soporte para GN 1/1
support pour GN 1/1

Buche massiv, Wenge
solid beech, colour wenge
haya maciza, color wengué
hêtre massif, couleur wengé



	cm	↑ cm	Farbe / Colour	€
14953	57,5 x 27,5	22		76,00



84047
GN 1/2

84047
GN 1/2

passendes Kühltablett Set



14956

14953

passende Besteck / Universal-Box GN 1/1



14954

Einsatz / insert

Besteck- / Universal-Box, 2-teilig „FRAMES“

cutlery tray, 2 pcs.
cubertero o cajón multi-usos, set de 2
caisson à couverts ou multi-usages, set de 2

Buche massiv, Wenge, 4 Fächer, inklusive herausnehmbaren Einsatz
solid beech, colour wenge, 4 compartments, including removable insert
haya maciza, color wengué, 4 compartimentos, con separador extraíble
hêtre massif, couleur wengé, 4 compartiments, avec insert amovible



	cm	↑ cm	GN	Farbe / Colour	€
14956	53 x 32,5	11	1/1		184,00

Einsatz für GN 1/1 „FRAMES“ / insert for GN1/1 / separador para GN1/1 / insert pour GN1/1

	cm	↑ cm	Farbe / Colour	€
14954	48,5 x 28	8		44,00



GN 1/1 Rolltophaube

GN 1/1 rolltop cover
GN 1/1 campana abatible
GN 1/1 cloche basculante

verchromter Zinkdruckguss-Griff
chrome plated metal handle
mango cromado de fundición a presión de zinc
poignée en zinc moulé sous pression chromé



	cm	↑ cm	GN	€
11018	53 x 32,5	17	1/1	64,00



GN 1/1 Rolltophaube

GN 1/1 rolltop cover
GN 1/1 campana abatible
GN 1/1 cloche basculante

patentiert, passend für GN-Behälter, -Tablets, etc., leichtgängig auf- und zuklappbar 90°
patented, suitable for GN containers, trays, etc., solid quality, 90° opening
patentada, para contenedores, bandejas GN, apertura 90°
brevetée, pour bacs, plateaux GN, ouverture 90°



	cm	↑ cm	GN	€
11008	53 x 32,5	17	1/1	64,00



BRIDGE

Mit hohem Anspruch an Design und Funktionalität haben wir das Buffet-System „Bridge“ für Sie entwickelt. Die in den Holzoberflächen Ahorn und Wenge erhältlichen Artikel sind in ihren Höhen und ihren Volumina optimal aufeinander abgestimmt und gewährleisten einen einfachen und sicheren Umgang in Ihrem Gastronomiealltag.

The collection "Bridge" is bringing perfectly coordinated components for an uncomplicated and organized buffet system, finalizing in a unique buffet scenery. All pieces combine perfectly with one another in their variations of sizes and volumes. The wooden items are available in 2 colors, maple or wenge. A simple and safe handling is guaranteed.

Una colección universal para un buffet único: un Sistema funcional y fácil de componer, asociado a la elegancia de su exclusivo diseño. Los elementos se combinan a la perfección entre variaciones de Alturas y volúmenes, realizando sus propuestas y composiciones culinarias y modelando el paisaje del buffet. Las piezas están disponibles en 2 colores, wengué o arce. Manejo sencillo y seguro.

Une collection universelle pour une présentation unique de votre buffet: fonctionnel et facile à composer, ce système est à la fois pratique, simple et spectaculaire par son élégant design. Les différents éléments se marient à la perfection pour construire sans difficulté différentes compositions, variant les hauteurs et les volumes et mettant en valeur vos créations culinaires. Les pièces sont disponibles en deux couleurs, bois wengé ou érable.



Kühlbox „BRIDGE“ refrigerated buffet display set de buffet refrigerado présentoir buffet froid



Set bestehend aus: 1 Gestell aus Ahorn oder Wenge, 1 Behälter aus Kunststoff, 1 GN1/1 Tablett aus Melamin, 1 Kühlakku, 1 Rolltophaube (fix montiert)

set consists of: 1 base element maple or wenge, 1 plastic insert black, 1 GN1/1 tray melamine, 1 cooler, 1 cover (fixed)

set compuesto por: 1 soporte de madera arce o wengué, 1 cubeta de plástico, 1 bandeja de melamina GN 1/1, 1 acumulador de frío, 1 campana rolltop (fija)

set composé de: 1 support en bois érable ou wengé, 1 bac plastique, 1 plat en mélamine GN 1/1, 1 accumulateur de froid, 1 cloche rolltop (fixe)

	cm	↑ cm	Farbe / Colour	€
13990	63,5 x 42,5	31	ahorn wood	370,00
14990	63,5 x 42,5	31	wenge wood	370,00

**Kühlschale „BRIDGE“**cooling bowl
bol refrigerado
bol réfrigéré**4-teilig: 1 Gestell aus Ahorn oder Wenge, 1 Behälter aus Edelstahl,
1 Schale aus Melamin (Ø 14 cm o. 23 cm), 1 Kühlakku**4 pcs.: 1 base element maple or wenge, 1 bowl stainless steel,
1 bowl melamine (Ø 14 or 23 cm), 1 coolerset de 4: 1 soporte de madera arce o wengué, 1 cuenco
de acero inoxidable, 1 cuenco de melamina (Ø 14 cm o 23 cm), 1 acumulador de fríoset de 4: 1 support en bois érable ou wengé, 1 bol en acier inox, 1 bol en mélamine
(Ø 14 cm ou 23 cm), 1 accumulateur de froid

	cm	↑ cm	ltr.	Farbe / Colour	€
13980	18,5 x 18,5	10	0,5		59,00
13981	27,5 x 27,5	14	2,5		114,00

	cm	↑ cm	ltr.	Farbe / Colour	€
14980	18,5 x 18,5	10	0,5		59,00
14981	27,5 x 27,5	14	2,5		114,00

**Edelstahlschale „BRIDGE“**stainless steel bowl
cuenco acero inoxidable
bol acier inox

	Ø cm	↑ cm		€
30050	14	8,5		26,00
30052	23	13,5		58,00

**Schale „CASUAL MAXI“**bowl
cuenco
bol

	Ø cm	↑ cm	ltr.	Farbe / Colour	€
83700	14	6,5	0,5		4,90
83702	23	10,5	2,5		11,80

	Ø cm	↑ cm	ltr.	Farbe / Colour	€
83701	14	6,5	0,5		4,90
83703	23	10,5	2,5		11,80

**Frischhaltecover**airtight cover
tapa hermética
couvre-cle hermétique

	Ø cm		€
10890	14		10,40
10887	23		19,00

Kühlakku / cooler / acumulador de frío / accumulateur de froid

	Ø cm	↑ cm	€
10661	10,5	2,0	3,40
10777	15,0	2,5	5,40



Milchdispenser „BRIDGE“

milk dispenser
dispensador de leche
distributeur à lait



Edelstahl Dispenser mit 1 Kühlakku im Standfuß inklusive touchless adapter

stainless steel dispenser with 1 cooling element in stand including touchless adapter
dispensador de acero inoxidable con 1 acumulador de frío en la base y con adaptador sin contacto para grifo
distributeur en acier inox avec 1 accumulateur de froid dans le socle et avec adaptateur sans contact manuel

	cm	↑ cm	ltr.	Farbe / Colour		€
10836	31 x 20	39	3		Ahorn / maple	279,00
10838	39 x 22	45	5		Ahorn / maple	444,00



Milchdispenser „BRIDGE“

milk dispenser
dispensador de leche
distributeur à lait



Edelstahl Dispenser mit 1 Kühlakku im Standfuß inklusive touchless adapter

stainless steel dispenser with 1 cooling element in stand including touchless adapter
dispensador de acero inoxidable con 1 acumulador de frío en la base y con adaptador sin contacto para grifo
distributeur en acier inox avec 1 accumulateur de froid dans le socle et avec adaptateur sans contact manuel

	cm	↑ cm	ltr.	Farbe / Colour		€
10837	31 x 20	39	3		Buche / beech	279,00
10839	39 x 22	45	5		Buche / beech	444,00



Saftdispenser „BRIDGE“

juice dispenser
dispensador de zumo
distributeur à jus



Kühlung durch 2 Kühlakkus von oben und unten

cooling with 2 cooling elements from the top and base
2 acumuladores de frío: 1 en la base y 1 en la tapa
2 accumulateurs de froid: 1 dans le couvercle et 1 dans le socle

	cm	↑ cm	ltr.	Farbe / Colour		€
10870	31,0 x 20	42	4		Ahorn / maple	239,00
10871	35,5 x 22	50	6		Ahorn / maple	279,00

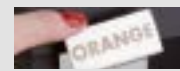

inklusive 3 Magnetschilder: ORANGE, APPLE, GRAPEFRUIT
including 3 magnetic signs: ORANGE, APPLE, GRAPEFRUIT



Saftdispenser „BRIDGE“

juice dispenser
dispensador de zumo
distributeur à jus



Kühlung durch 2 Kühlakkus von oben und unten

cooling with 2 cooling elements from the top and base
2 acumuladores de frío: 1 en la base y 1 en la tapa
2 accumulateurs de froid: 1 dans le couvercle et 1 dans le socle

	cm	↑ cm	ltr.	Farbe / Colour		€
10872	31,0 x 20	42	4		Wenge / wenge	239,00
10873	35,5 x 22	50	6		Wenge / wenge	279,00



inklusive 3 Magnetschilder: ORANGE, APPLE, GRAPEFRUIT
including 3 magnetic signs: ORANGE, APPLE, GRAPEFRUIT



4,5 ltr.

Cerealienspender „BRIDGE“

cereal dispenser
dispensador de cereales
distributeur de céréales



Behälter herausnehmbar, „Feierabend-Deckel“ für das aromadichte Lagern, Portionieren durch einfaches Drehen

removable canister, special lid to keep the cereals fresh, easy to use, rotate the button to get the muesli

contenedor extraíble, tapa especial para mantener los cereales frescos, fácil de usar, se gira el pomo para servir los cereales

réceptif amovible, couvercle spécial pour conserver les céréales, usage facile en tournant le bouton

	cm	↑ cm	ltr.	Farbe / Colour		€
13987	21 x 20	55,5	4,5		Ahorn / maple	109,00



4,5 ltr.

Cerealienspender „BRIDGE“

cereal dispenser
dispensador de cereales
distributeur de céréales



Behälter herausnehmbar, „Feierabend-Deckel“ für das aromadichte Lagern, Portionieren durch einfaches Drehen

removable canister, special lid to keep the cereals fresh, easy to use, rotate the button to get the muesli

contenedor movible, tapa especial para mantener los cereales frescos, fácil de usar, se gira el pomo para servir los cereales

réceptif amovible, couvercle spécial pour conserver les céréales, usage facile en tournant le bouton

	cm	↑ cm	ltr.	Farbe / Colour		€
14987	21 x 20	55,5	4,5		Buche / beech	109,00

**Besteckbehälter „BRIDGE“**

cutlery organizer
cajón para cubiertos
bac à couverts



2 teiliges Set: 1 Gestell, 1 Besteckbehälter (Nr. 11955), herausnehmbar

2 pcs.: 1 base element, 1 removable plastic container (item 11955)

set de 2: 1 soporte, 1 cajón para cubiertos (ref. 11955) extraíble

set de 2: 1 support, 1 bac à couverts (réf. 11955) amovible

	cm	↑ cm	Farbe / Colour		€
13995	57,5 x 37	12		Ahorn / maple	88,00

**Besteckbehälter „BRIDGE“**

cutlery organizer
cajón para cubiertos
bac à couverts



2 teiliges Set: 1 Gestell, 1 Besteckbehälter (Nr. 11955), herausnehmbar

2 pcs.: 1 base element, 1 removable plastic container (item 11955)

set de 2: 1 soporte, 1 cajón para cubiertos (ref. 11955) extraíble

set de 2: 1 support, 1 bac à couverts (réf. 11955) amovible

	cm	↑ cm	Farbe / Colour		€
14995	57,7 x 37	12		Buche / beech	88,00

SUPERBOX



Die stapelbaren Wendeboxen lassen sich rutschfest stapeln und mit flachen GN Platten verbinden und einzeln nutzen. Individuell können Buffet-landschaften gebaut werden.

The stackable and non-slip reversible boxes can be connected to flat GN trays and can also be used individually. Different and individual buffet sceneries can be built up.

Las cajas girables y apilables son antideslizantes y se pueden conectar con bandejas planas GN o utilizar individualmente. Se pueden construir diferentes paisajes de buffet muy individuales.

Les boîtes de tournage empilables sont antiglissantes et peuvent être connectées avec des plateaux plats GN ou utilisées individuellement. Des paysages de buffet très personnalisés peuvent être construits.



11626

11721

GN 1/1 „SUPERBOX“



Akazienholz / acacia wood / madera de acacia / bois d'acacia

	cm	↑ cm	GN	Farbe / Colour	€
11620	55,5 x 35,0	10,5	1/1		46,00
11626	55,5 x 35,0	10,5	1/1		46,00
11721	55,5 x 35,0	20,0	1/1		69,00
11723	55,5 x 35,0	20,0	1/1		69,00



11623

GN 2/4 „SUPERBOX“



Akazienholz / acacia wood / madera de acacia / bois d'acacia

	cm	↑ cm	GN	Farbe / Colour	€
11623	55,5 x 18,5	10,5			36,00
11629	55,5 x 18,5	10,5			36,00



11627

11724

GN 1/2 „SUPERBOX“



Akazienholz / acacia wood / madera de acacia / bois d'acacia

	cm	↑ cm	GN	Farbe / Colour	€
11621	35,0 x 29,0	10,5	1/2		29,00
11627	35,0 x 29,0	10,5	1/2		29,00
11722	35,0 x 29,0	20,0	1/2		44,00
11724	35,0 x 29,0	20,0	1/2		44,00



GN 1/4 „SUPERBOX“

Akazienholz / acacia wood / mader de acacia / bois d'acacia



	cm	↑ cm	Farbe / Colour	€
11622	29 x 18,5	10,5		23,00
11628	29 x 18,5	10,5		23,00



GN „SUPERBOX VINTAGE“

Akazienholz
acacia wood
mader de acacia
bois d'acacia

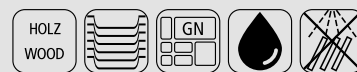

	cm	↑ cm	GN	Farbe / Colour	€
11715	55,5 x 35,0	10,5	1/1		46,00
11716	35,0 x 29,0	10,5	1/2		29,00
11717	29,0 x 18,5	10,5	1/4		23,00
11718	55,0 x 18,5	10,5	2/4		36,00



Präsentationsmöglichkeiten
presentation examples



Buffetgestell

buffet stand
soporte para buffet
présentoir buffet



Metall, schwarz, passend für GN Boxen, mit Antrutschfüßchen
metal, black, suitable for GN boxes, with non-slip feet
metal, negro, apto para cajas GN, con pies antideslizantes
métal, noir, pour boîtes GN, avec pieds antidérapants

	cm	↑ cm	suitable for	€
30331	49 x 38,5	48	GN 1/1, GN1/2 boxes	48,00



Präsentationsmöglichkeit
presentation example



GN Tablett „ZERO“

GN tray
GN bandeja
GN plateau



	cm	↑ cm	GN	Farbe / Colour	€
84185	53,0 x 32,5	1,5	1/1		41,40
84186	32,5 x 26,5	1,5	1/2		22,40
84188	26,5 x 16,2	1,5	1/4		12,60
84189	53,0 x 16,2	1,5	2/4		24,60



mit Antirutschfüßchen
with non-slip feet



GN Naturschieferplatten

GN natural slate tray
GN bandeja de pizarra natural
GN plat ardoise naturelle



	cm	GN	€
00990	53,0 x 32,5	1/1	15,80
00991	32,5 x 26,5	1/2	8,80
00993	26,5 x 16,2	1/4	5,00
00973	53,0 x 16,2	2/4	6,50



GN Einsatz „SUPERBOX“

GN insert
GN bandeja
GN bac supérieur



	cm	↑ cm	GN	fits to	€
11616	53,0 x 32,5	8,5	1/1	11620, 11626, 11715	30,00
11617	32,5 x 26,5	8,5	1/2	11621, 11627, 11716	25,00



NEW **4 tlg. 4 pcs.**



11546



11075

Buche, wasserfest lackiert
beech wood lacquered



10791

Kühlakku halten Ihre Speisen bis zu 6 Stunden kühl
cooling system keeps the food cool for up to 6 hours

Buffetvitrine „TOP FRESH GN 1/1“
refrigerated buffet display
expositor buffet frío
plateau buffet froid



4-teilig: 1 Box aus Buchenholz mit Kunststoffwanne + 1 Edelstahl-Tablett GN 1/1 + 2 Kühlakkus, ohne Haube

4 pcs.: 1 beech wood box with plastic insert + 1 stainless steel tray GN 1/1 + 2 coolers, without cover

set de 4: 1 caja de madera de haya con bandeja de plástico + 1 bandeja de acero inoxidable GN 1/1 + 2 acumuladores de frío, sin campana

set de 4: 1 boîte en bois de hêtre avec bac en plastique + 1 plateau en acier inox GN 1/1 + 2 accumulateurs de froid, sans cloche

	cm	↑ cm	€
11546	60 x 41	5	189,00

GN Rolltophaube mit schwarzem Griff / GN rolltop cover with black handle / GN campana rolltop con mango negro / GN cloche rolltop avec poignée noir

	cm	↑ cm	GN	€
11075	53 x 32,5	19	1/1	62,00

GN Rolltophaube mit Chromgriff / GN rolltop cover with chrome handle / GN campana rolltop con asa cromada / GN cloche rolltop avec poignée chromée

	cm	↑ cm	GN	€
11010	53 x 32,5	19	1/1	62,00

Kühlakku / cooler / acumulador de frío / accumulateur de froid

	cm	↑ cm	€
10791	25 x 19	2,5	7,90

NEW **12 tlg. 12 pcs.**



11547

Buche, wasserfest lackiert
beech wood lacquered



10791

Kühlakku halten Ihre Speisen bis zu 6 Stunden kühl
cooling system keeps the food cool for up to 6 hours

Buffetvitrine „DOPPELDECKER GN 1/1“
refrigerated buffet display
expositor buffet frío
plateau buffet froid



12-teilig: 2 Boxen aus Buchenholz mit Kunststoffwanne + 2 Edelstahl-Tabletts GN 1/1 + 4 Kühlakkus + 4 verchromte Stangen, ohne Hauben

12 pcs.: 2 beech wood boxes with plastic insert + 2 stainless steel trays GN 1/1 + 4 coolers + 4 chrome-plated bars, without covers

set de 12: 2 cajas de madera de haya con bandeja de plástico + 2 bandejas de acero inoxidable GN 1/1 + 4 acumuladores de frío + 4 barras cromadas, sin campanas

set de 12: 2 boîtes en bois de hêtre avec bac en plastique + 2 plateaux en acier inox GN 1/1 + 4 accumulateurs de froid + 4 barres chromées, sans cloches

	cm	↑ cm	€
11547	60 x 41	36	348,00

GN Rolltophaube mit schwarzem Griff / GN rolltop cover with black handle / GN campana rolltop con asa negra / GN cloche rolltop avec poignée noir

	cm	↑ cm	GN	€
11075	53 x 32,5	19	1/1	62,00

GN Rolltophaube mit Chromgriff / GN rolltop cover with chrome handle / GN campana rolltop con asa cromada / GN cloche rolltop avec poignée chromée

	cm	↑ cm	GN	€
11010	53 x 32,5	19	1/1	62,00

Kühlakku / cooler / acumulador de frío / accumulateur de froid

	cm	↑ cm	€
10791	25 x 19	2,5	7,90

COOLING DISPLAYS

4 tlg.
4 pcs.



11540



11010

Buche, wasserfest lackiert
beech wood lacquered



10791

Kühlakku halten Ihre Speisen bis zu 6 Stunden kühl
cooling system keeps the food cool for up to 6 hours

Buffetvitrine „TOP FRESH GN 1/1“

refrigerated buffet display
expositor buffet frío
plateau buffet froid



4-teilig: 1 Box aus Buchenholz mit Kunststoffwanne + 1 Edelstahl-Tablett GN 1/1 + 2 Kühlakku, ohne Haube

4 pcs.: 1 beech wood box with plastic insert + 1 stainless steel tray GN 1/1 + 2 coolers, without cover

set de 4: 1 caja de madera de haya con bandeja de plástico + 1 bandeja de acero inoxidable GN 1/1 + 2 acumuladores de frío, sin campana

set de 4: 1 boîte en bois de hêtre avec bac en plastique + 1 plateau en acier inox GN 1/1 + 2 accumulateurs de froid, sans cloche

	cm	↑ cm	€
11540	60 x 41	5	189,00

GN Rolltophaube mit Goldgriff / GN rolltop cover with gold handle / GN campana rolltop con asa dorada / GN cloche rolltop avec poignée en or

	cm	↑ cm	GN	€
11008	53 x 32,5	19	1/1	62,00

GN Rolltophaube mit Chromgriff / GN rolltop cover with chrome handle / GN campana rolltop con asa cromada / GN cloche rolltop avec poignée chromée

	cm	↑ cm	GN	€
11010	53 x 32,5	19	1/1	62,00

Kühlakku / cooler / acumulador de frío / accumulateur de froid

	cm	↑ cm	€
10791	25 x 19	2,5	7,90

12 tlg.
12 pcs.



11541

Buche, wasserfest lackiert
beech wood lacquered



10791

Kühlakku halten Ihre Speisen bis zu 6 Stunden kühl
cooling system keeps the food cool for up to 6 hours

Buffetvitrine „DOPPELDECKER GN 1/1“

cooling buffet display
expositor buffet frío
vitrine buffet



12-teilig: 2 Boxen aus Buchenholz mit Kunststoffwanne + 2 Edelstahl-Tabletts GN 1/1 + 4 Kühlakku + 4 verchromte Stangen, ohne Hauben

12 pcs.: 2 beech wood boxes with plastic insert + 2 stainless steel trays GN 1/1 + 4 coolers + 4 chrome-plated bars, without covers

set de 12: 2 cajas de madera de haya con bandeja de plástico + 2 bandejas de acero inoxidable GN 1/1 + 4 acumuladores de frío + 4 barras cromadas, sin campanas

set de 12: 2 boîtes en bois de hêtre avec bac en plastique + 2 plateaux en acier inox GN 1/1 + 4 accumulateurs de froid + 4 barres chromées, sans cloches

	cm	↑ cm	€
11541	60 x 41	36	348,00

GN Rolltophaube mit Goldgriff / GN rolltop cover with gold handle / GN campana rolltop con asa dorada / GN cloche rolltop avec poignée en or

	cm	↑ cm	GN	€
11008	53 x 32,5	19	1/1	62,00

GN Rolltophaube mit Chromgriff / GN rolltop cover with chrome handle / GN campana rolltop con asa cromada / GN cloche rolltop avec poignée chromée

	cm	↑ cm	GN	€
11010	53 x 32,5	19	1/1	62,00

Kühlakku / cooler / acumulador de frío / accumulateur de froid

	cm	↑ cm	€
10791	25 x 19	2,5	7,90

3 tlg.
3 pcs.



11542

Buche, wasserfest lackiert
beech wood lacquered



18388

11542



10791

Kühlakkus halten Ihre Speisen
bis zu 6 Stunden kühl
cooling system keeps the food
cool for up to 6 hours

Kühltablett „TOP FRESH RUND“

refrigerated buffet display
expositor buffet frío redondo
présentoir buffet



3-teilig: 1 Box aus Buchenholz mit Kunststoffwanne + 1 Edelstahl-Tablett Ø 38 cm + 1 Kühlakku, ohne Haube

3 pcs.: 1 beech wood box with plastic insert + 1 stainless tray Ø 38 cm + 1 cooler, without cover

set de 3: 1 caja de madera de haya con bandeja de plástico + 1 bandeja de acero inoxidable Ø 38 cm + 1 acumulador de frío, sin campana

set de 3: 1 boîte en bois de hêtre avec bac en plastique + 1 plateau en acier inox Ø 38 cm + 1 accumulateur de froid, sans cloche

	Ø cm	↑ cm	€
11542	48	6	189,00

Rolltophaube mit verchromtem Kugelgriff / rolltop cover with chrome-plated ball handle / campana abatible con asa de bola cromada / cloche basculante avec poignée boule chromée

	Ø cm	↑ cm	€
18388	38	20	24,00

Rolltophaube mit vergoldetem Kugelgriff / rolltop cover with gold-plated ball handle / campana abatible con asa de bola dorada / cloche basculante avec poignée boule plaquée or

	Ø cm	↑ cm	€
18387	38	20	24,00

Kühlakku / cooler / acumulador de frío / accumulateur de froid

	cm	↑ cm	€
10791	25 x 19	2,5	7,90

11 tlg.
11 pcs.



18388

18388

11543

Buche, wasserfest lackiert
beech wood lacquered



10791

Kühlakkus halten Ihre Speisen
bis zu 6 Stunden kühl
cooling system keeps the food
cool for up to 6 hours

Buffetvitrine „DOPPELDECKER“

double refrigerated buffet display
expositor de buffet redondo doble
présentoir buffet froid, double



11-teilig: 2 Boxen aus Buchenholz mit Kunststoffwanne + 2 Edelstahl-Tablets Ø 38 cm + 2 Kühlakkus + 2 Kunststoffschalen + 3 verchromte Stangen, ohne Hauben

11 pcs.: 2 beech wood boxes with plastic tray + 2 stainless steel trays Ø 38 cm, 2 coolers + 3 chrome-plated bars, without covers

set de 11: 2 cajas de madera de haya con bandeja de plástico + 2 bandejas de acero inoxidable Ø 38 cm + 2 acumuladores de frío + 2 bandejas de plástico + 3 barras cromadas, sin campanas

set de 11: 2 boîtes en bois de hêtre avec bac en plastique + 2 plateaux en inox Ø 38 cm + 2 accumulateurs de froid + 2 plateaux en plastique + 3 barres chromées, sans cloches

	Ø cm	↑ cm	€
11543	48	38	312,00

Rolltophaube mit verchromtem Kugelgriff / rolltop cover with chrome-plated ball handle / campana abatible con asa de bola cromada / cloche basculante avec poignée boule chromée

	Ø cm	↑ cm	€
18388	38	20	24,00

Rolltophaube mit vergoldetem Kugelgriff / rolltop cover with gold-plated ball handle / campana abatible con asa de bola dorada / cloche basculante avec poignée boule plaquée or

	Ø cm	↑ cm	€
18387	38	20	24,00

Kühlakku / cooler / acumulador de frío / accumulateur de froid

	cm	↑ cm	€
10791	25 x 19	2,5	7,90

COOLING DISPLAYS



Kühlbox „SLATE“ refrigerated buffet display expositor buffet frío plateau buffet froid

3-teilig, bestehend aus: 1 Basis aus schwarzem Polystyrol,
1 Naturschieferplatte, 1 Kühlakku (ohne Haube)

3 pcs., set consists of: 1 base made of black polystyrene, 1 natural slate tray, 1 cooler (without cover)

set de 3 compuesto por: 1 soporte de poliestireno negro, 1 bandeja de pizarra natural, 1 acumulador de frío (sin campana)

set de 3 composé de: 1 support en polystyrène noir, 1 plateau en ardoise naturelle, 1 accumulateur de froid (sans couvercle)



	cm	↑ cm	€
11645	58 x 38	6,5	80,00

Naturschieferplatte / natural slate tray / bandeja de pizarra natural / plateau ardoise naturelle

	cm	✂ mm	€
00979 <small>NEW</small>	58 x 38	6 - 9	19,00

Kühlakku / cooler / acumulador de frío / accumulateur de froid

	cm	↑ cm	€
10782	41 x 21	2,5	16,00

GN Rolltophaube mit schwarzem Griff / GN rolltop cover with black handle / GN campana rolltop con mango negro / GN cloche rolltop avec poignée noire

	cm	↑ cm	GN	€
11075 <small>NEW</small>	53 x 32,5	19	1/1	62,00



Buffetvitrine „TOP FRESH GN 1/1“ cooling buffet display expositor buffet frío présentoir buffet

5-teilig: 1 Edelstahl-Tablett GN 1/1 + 2 Kühlakkus + 1 Edelstahl-Schale + 1 Acrylrahmen, ohne Haube

5 pcs.: 1 stainless steel tray GN 1/1 + 2 coolers + 1 stainless steel tray + 1 acrylic frame, without cover

set de 5: 1 bandeja de acero inoxidable GN 1/1 + 2 acumuladores de frío + 1 bandeja de acero inoxidable, 1 marco acrílico, sin campana

set de 5: 1 plateau en acier inox GN 1/1 + 2 accumulateurs de froid + 1 plateau inox - 1 cadre acrylique, sans cloche



	cm	↑ cm	€
11510	61 x 38	8	224,00

Buffetvitrine „DOPPELDECKER GN1/1“ cooling buffet display expositor buffet frío présentoir buffet

14-teilig: 2 Edelstahl-Tabletts GN 1/1 + 4 Kühlakkus + 2 Edelstahl-Schale + 2 Acrylrahmen + 4 verchromte Stangen, ohne Hauben

14 pcs.: 2 stainless steel trays GN 1/1 + 4 coolers + 2 stainless steel trays, 2 acrylic frame + 4 chrome-plated bars, without covers

set de 14: 2 bandejas de acero inoxidable GN 1/1 + 4 acumuladores de frío + 2 bandejas de acero inoxidable + 2 marcos acrílicos, 4 barras cromadas, sin campana

set de 14: 2 plateaux en acier inox GN 1/1 + 4 accumulateurs de froid, 2 bacs en acier inox + 2 cadres en acrylique + 4 barres chromées, sans cloches



	cm	↑ cm	€
11514	61 x 38	33	398,00

GN Rolltophaube / GN rolltop cover / GN campana rolltop / GN cloche rolltop

	cm	↑ cm	GN	€
11010	53 x 32,5	19	1/1	62,00

Kühlakku / cooler / acumulador de frío / accumulateur de froid

	cm	↑ cm	€
10791	25 x 19	2,5	7,90

4 tlg.
4 pcs.

18388

11512

18388

11101

Kühlakkus halten Ihre Speisen bis zu 6 Stunden kühl
cooling system keeps the food cool for up to 6 hours

Kühltablett „TOP FRESH RUND“

cooling plate
expositor buffet frío
présentoir buffet



4-teilig: 1 Edelstahl-Tablett Ø 38 cm + 2 Kühlakkus + 1 Edelstahl-Schale + 1 Acrylrahmen, ohne Haube

4 pcs.: 1 stainless steel tray Ø 38 cm + 2 coolers + 1 stainless steel tray + 1 acrylic frame, without cover

set de 4: 1 bandeja de acero inox Ø 38 cm + 2 acumuladores de frío + 1 bandeja de acero inox + 1 marco acrílico, sin campana

set de 4: 1 plateau en acier inox Ø 38 cm + 2 accumulateurs de froid + 1 cadre acrylique, sans cloche

	Ø cm	↑ cm	€
11512	43,5	5,5	184,00

Rolltophaube mit verchromtem Kugelgriff / rolltop cover with chrome-plated ball handle / campana abatible con asa de bola cromada / cloche basculante avec poignée boule chromée

	Ø cm	↑ cm	€
18388	38	20	24,00

Kühlakku / cooler / acumulador de frío / accumulateur de froid

	cm	↑ cm	pcs.	€ / set
11101	16 x 7,5	2	4	6,60

4 tlg.
4 pcs.

11010

11503

11100

11505

11010

11505

10791

Kühlakkus halten Ihre Speisen bis zu 6 Stunden kühl
cooling system keeps the food cool for up to 6 hours

Kühlbox „TOP FRESH GN 1/1“

cooling plate
bandeja de frío
présentoir buffet réfrigéré



4-teilig: 1 Kühlbox + 1 Tablett GN 1/1 + 2 Kühlakkus, ohne Haube

4 pcs.: 1 box + 1 tray GN 1/1 + 2 coolers, without cover

set de 4: 1 caja + 1 bandeja GN 1/1 + 2 acumuladores de frío, sin campana

set de 4: 1 caisson + 1 plateau GN 1/1 + 2 accumulateurs de froid, sans cloche

	cm	↑ cm	Farbe / Colour	€
11503	56,5 x 35	6,5	White	104,00
11505	56,5 x 35	6,5	Black	104,00

GN Rolltophaube mit vergoldetem Kreuzgriff / GN rolltop cover with gold-plated cross handle / GN campana rolltop con asa en cruz dorada / GN cloche rolltop avec manche en croix plaqué or

	cm	↑ cm	GN	€
11008	53,0 x 32,5	19	1/1 mit vergoldetem Kreuzgriff	62,00

GN Rolltophaube mit verchromtem Kreuzgriff / GN rolltop cover with chrome-plated cross handle / GN campana rolltop con asa en cruz cromada / GN cloche rolltop avec manche en croix chromée

	cm	↑ cm	GN	€
11010	53 x 32,5	19	1/1 mit verchromtem Kreuzgriff	62,00

Kühlakku / cooler / acumulador de frío / accumulateur de froid

	cm	↑ cm	€
10791	25 x 19	2,5	7,90

GN Edelstahl-Tablett „PROFI LINE“ / GN tray / GN bandeja / GN plateau

	cm	↑ cm	GN	€
11100	53 x 32,5	1,5	1/1	31,00

COOLING DISPLAYS



18388

11538

10791

Kühlakkus halten Ihre Speisen bis zu 6 Stunden kühl
cooling system keeps the food cool for up to 6 hours

Kühlbox „TOP FRESH SET“

cooling plate
bandeja de frío
set frigorifère



3-teilig: 1 Box + 1 Tablett Ø 38 cm + 1 Kühlakku, ohne Haube

3 pcs.: 1 box + 1 tray Ø 38 cm + 1 cooler, without cover

set de 3: 1 caja + 1 bandeja Ø 38 cm + 1 acumulador de frío, sin campana

set de 3: 1 caisson + 1 plateau Ø 38 cm + 1 accumulateur de froid, sans cloche

	Ø cm	↑ cm	Farbe / Colour	€
11538	42	6		84,00
11533	42	6		84,00

Rolltophaube mit verchromtem Kugelgriff / rolltop cover with chrome-plated ball handle / campana abatible con asa de bola cromada / cloche basculante avec poignée boule chromée

	Ø cm	↑ cm	€
18388	38	20	24,00

Kühlakku / cooler / acumulador de frío / accumulateur de froid

	cm	↑ cm	€
10791	25 x 19	2,5	7,90



18388

09082

11101

Kühlakkus halten Ihre Speisen bis zu 6 Stunden kühl
cooling system keeps the food cool for up to 6 hours

Thermo-Set

thermo set
bandeja isotérmica
set thermo



5-teilig: 1 Tablett tief + 1 Tablett flach + 2 Kühlakkus + 1 Rolltophaube

5 pcs.: 1 deep tray + 1 tray + 2 cooler + 1 rolltop cover

set de 5: 1 1 bandeja honda + 1 bandeja plana + 2 acumuladores frío + 1 campana rolltop

set de 5: 1 plateau creux + 1 plateau plat + 2 accumulateurs de froid + 1 cloche rolltop

	Ø cm	↑ cm	€
09082	38	24	52,00

Rolltophaube mit verchromtem Kugelgriff / rolltop cover with chrome-plated ball handle / campana abatible con asa de bola cromada / cloche basculante avec poignée boule chromée

	Ø cm	↑ cm	€
18388	38	20	24,00

Kühlakku / cooler / acumulador de frío / accumulateur de froid

	cm	↑ cm	pcs.	€ / set
11101	16 x 7,5	2	4	6,60



4 tlg.
4 pcs.

09083

11101

Kühlakkus halten Ihre Speisen bis zu 6 Stunden kühl
cooling system keeps the food cool for up to 6 hours

Thermo-Set

thermo set
porta tartas refrigerado
porte-gâteau réfrigéré



4-teilig: 1 Tablett tief auf Fuß + 1 Tablett flach + 2 Kühlakkus

4 pcs.: 1 deep tray with feet + 1 tray + 2 coolers

set de 4: 1 bandeja honda con pie + 1 1 bandeja plana + 2 acumuladores de frío

set de 4: 1 plateau creux avec pied + 1 plateau plat + 2 accumulateurs de froid

	Ø cm	↑ cm	€
09083	38	14,5	52,00

Rolltophaube mit verchromtem Kugelgriff / rolltop cover with chrome-plated ball handle / campana abatible con asa de bola cromada / cloche basculante avec poignée boule chromée

	Ø cm	↑ cm	€
18388	38	20	24,00

Kühlakku / cooler / acumulador de frío / accumulateur de froid

	cm	↑ cm	pcs.	€ / set
11101	16 x 7,5	2	4	6,60



4 tlg.
4 pcs.

9 cm

11812 0,6 ltr.



11,5 cm

11813 1 ltr.



10661

Kühlakkus halten Ihre Speisen bis zu 6 Stunden kühl
cooling system keeps the food cool for up to 6 hours

Kühlschale Mini Holz „TOP FRESH“

cool bowl mini holz
bol refrigerado mini madera
bol réfrigéré mini bois



4-teilig: 1 Fuß Buchenholz versiegelt + 1 Schale + 1 Kühlakku + 1 klappbarer Deckel mit Beschriftungsschild

4 pcs.: 1 foot beech wood + 1 bowl + 1 cooler + 1 hinged cover with label

set de 4: 1 base de madera de haya + 1 cuenco + 1 acumulador de frío + 1 tapa abatible con etiqueta

set de 4: 1 pied en hêtre + 1 bac + 1 accumulateur de froid + 1 couvercle à charnière avec étiquette

	Ø cm	↑ cm	ltr.	€
11812	14	9,0	0,6	44,00
11813	14	11,5	1,0	48,00

Ersatzschale / spare bowl / cuenco de recambio / bol de rechange

	Ø cm	↑ cm	€
11811	14	6,5	18,20
11816	14	9,0	25,40

Schutzdeckel mit Löffelaussparung / cover / tapa / couvercle

	Ø cm	€
11868	14,5	12,00

Kühlakku / cooler / acumulador de frío / accumulateur de froid

	Ø cm	↑ cm	€
10661	10,5	2	3,40



4 tlg.
4 pcs.

14 cm

11817 2,5 ltr.



18 cm

11818 4 ltr.

Kühlschale Maxi Holz „TOP FRESH“

cool bowl maxi holz
bol refrigerado maxi madera
bol réfrigéré maxi bois



4-teilig: 1 Fuß Buchenholz versiegelt + 1 Schale + 1 Kühlakku + 1 klappbarer Deckel mit Beschriftungsschild

4 pcs.: 1 foot beech wood + 1 bowl + 1 cooler + 1 hinged cover with label

set de 4: 1 base de madera de haya + 1 cuenco + 1 acumulador de frío + 1 tapa abatible con etiqueta

set de 4: 1 pied en hêtre + 1 bac + 1 accumulateur de froid + 1 couvercle à charnière avec étiquette

	Ø cm	↑ cm	ltr.	€
11817	22	14	2,5	104,00
11818	22	18	4,0	112,00

Ersatzschale / spare bowl / cuenco de recambio / bol de rechange

	Ø cm	↑ cm	€
11846	22	8	41,00
11848	22	12	54,00

Schutzdeckel mit Löffelaussparung / cover / tapa / couvercle

	Ø cm	€
11878	23,5	12,60

Kühlakku / cooler / acumulador de frío / accumulateur de froid

	Ø cm	↑ cm	€
10777	15	2,5	5,40

COOLING DISPLAYS

4 tlg.
4 pcs.

9 cm

11812 0,6 ltr.

11,5 cm

11815 1 ltr.

10661

Kühlakku halten Ihre Speisen bis zu 6 Stunden kühl
cooling system keeps the food cool for up to 6 hours

Kühlschale Mini „TOP FRESH“

cool bowl mini
bol refrigerado mini
bol réfrigéré mini



4-teilig: 1 Edelstahlgefäß matt + 1 Kühlakku + 1 Schale + 1 klappbarer Deckel mit Beschriftungsschild

4 pcs.: 1 stainless steel bowl matt + 1 bowl + 1 cooler + 1 hinged cover with label

set de 4: 1 recipiente de acero inoxidable mate + 1 cuenco + 1 acumulador de frío + 1 tapa abatible con etiqueta

set de 4: 1 récipient en acier inox mat + 1 bac + 1 accumulateur de froid + 1 couvercle à charnière avec étiquette

	Ø cm	↑ cm	ltr.	€
11810	14	9,0	0,6	48,00
11815	14	11,5	1,0	50,00

Ersatzschale / spare bowl / cuenco de recambio / bol de rechange

	Ø cm	↑ cm	€
11811	14	6,5	18,20
11816	14	9,0	25,40

Schutzdeckel mit Löffelaussparung / cover / tapa / couvercle

	Ø cm	€
11868	14,5	12,00

Kühlakku / cooler / acumulador de frío / accumulateur de froid

	Ø cm	↑ cm	€
10661	10,5	2	3,40

4 tlg.
4 pcs.

14 cm

11847
2,5 ltr.

18 cm

11849
4 ltr.

Kühlschale Maxi „TOP FRESH“

cool bowl maxi
bol refrigerado maxi
bol réfrigéré maxi



4-teilig: 1 Edelstahlgefäß hochglanzpoliert + 1 Kühlakku + 1 Schale + 1 klappbarer Deckel mit Beschriftungsschild

4 pcs.: 1 stainless steel bowl matt + 1 bowl + 1 cooler + 1 hinged cover with label

set de 4: 1 recipiente de acero inoxidable mate + 1 cuenco + 1 acumulador de frío + 1 tapa abatible con etiqueta

set de 4: 1 récipient en acier inox mat + 1 bac + 1 accumulateur de froid + 1 couvercle à charnière avec étiquette

	Ø cm	↑ cm	ltr.	€
11847	22	14	2,5	108,00
11849	22	18	4,0	112,00

Ersatzschale / spare bowl / cuenco de recambio / bol de rechange

	Ø cm	↑ cm	€
11846	22	8	41,00
11848	22	12	54,00

Schutzdeckel mit Löffelaussparung / cover / tapa / couvercle

	Ø cm	€
11878	23,5	12,60

Kühlakku / cooler / acumulador de frío / accumulateur de froid

	Ø cm	↑ cm	€
10777	15	2,5	5,40

4 tlg.
4 pcs.



11845
2,5 ltr.



11875

Kühlschale Maxi „TOP FRESH“

cool bowl maxi
cuenco refrigerado maxi
bol réfrigéré maxi



4-teilig: 1 Gefäß hochglanzpoliert + 1 Kühlakku + 1 Glasschale + 1 klappbarer Deckel mit Beschriftungsschild

4 pcs.: 1 stainless steel bowl mirror polished + 1 cooler + 1 glass bowl + 1 hinged cover with label

set de 4: 1 recipiente de acero inoxidable pulido brillante + 1 acumulador de frío + 1 cuenco de vidrio + 1 tapa abatible con etiqueta

set de 4: 1 récipient en acier inox poli mat + 1 accumulateur de froid + 1 bol en verre + 1 couvercle à charnière avec étiquette

	Ø cm	↑ cm	ltr.	€
11845	23	14	2,5	84,00

Ersatzschale / spare bowl / cuenco de recambio / bol de rechange

	Ø cm	↑ cm	ltr.	€
11875	23	10,5	2,5	6,40

Schutzdeckel mit Löffelaussparung / cover / tapa / couvercle

	Ø cm	€
11878	23,5	12,60

Kühlakku / cooler / acumulador de frío / accumulateur de froid

	Ø cm	↑ cm	€
10777	15	2,5	5,40

Schale „CASUAL MAXI“

bowl
cuenco
bol



83696



83705



83920

	Ø cm	↑ cm	ltr.	Farbe / Colour	€
83696	10	4,5	0,15		3,50
83698	12	5,5	0,25		4,20
83700	14	6,5	0,50		4,90
83704	20	9,2	1,80		10,40
83702	23	10,5	2,50		11,80

	Ø cm	↑ cm	ltr.	Farbe / Colour	€
83697	10	4,5	0,15		3,50
83699	12	5,5	0,25		4,20
83701	14	6,5	0,50		4,90
83705	20	9,2	1,80		10,40
83703	23	10,5	2,50		11,80

Deckel „FLOAT“ mit Löffelaussparung / cover, with notched for spoons / tapa, con espacio para la cuchara / couvercle, avec encoche pour la louche

	Ø cm	↑ cm	fits to	€
83920	20,5	1,3	83704, 83705	9,20

COOLING DISPLAYS

09100

09102

90902

11101

Kühlakkus halten Ihre Speisen bis zu 6 Stunden kühl
cooling system keeps the food cool for up to 6 hours

Buffetvitrine showcase vitrina de buffet vitrine de buffet



5-teilig: 1 transparente Rolltophaube beidseitig aufklappbar + 1 Schale (ABS)
+ 1 Edelstahl-Tablett 39 x 28 cm + 2 Kühlakkus

5 pcs.: 1 transparent rolltop cover + 1 tray (ABS) + 1 stainless tray 39 x 28 cm + 2 coolers
set de 5: 1 tapa abatible, por ambos lados, transparente + 1 bandeja (ABS) + 1 bandeja de
acero inoxidable 39 x 28 cm + 2 acumuladores de frío

set de 5: 1 cloche transparente ouverture 2 côtés + 1 caisson (ABS) + 1 plateau en acier inox
39 x 28 cm + 2 accumulateurs de froid

	cm	↑ cm	Farbe / Colour	€
09100	44 x 32	20,5		48,00
09102	44 x 32	20,5		48,00
09104	44 x 32	20,5		48,00

Kühlakku / cooler / acumulador de frío / accumulateur de froid

	cm	↑ cm	pcs.	€ / set
11101	16 x 7,5	2	4	6,60

Edelstahl-Tablett / stainless steel tray / bandeja de acero inoxidable / plateau inox

	cm	↑ cm	€
90902	39,5 x 28,5	1	9,60



Servierbeispiel
presentation example

09200

09202

09204

Buffetvitrine „DOPPELDECKER“ showcase vitrina de buffet, 2 alturas vitrine de buffet double



2 transparente Rolltophauben beidseitig aufklappbar + 2 Schalen (ABS) + 2 Edelstahl-Tabletts
39 x 28 cm + 4 Kühlakkus, platzsparend lagerbar

2 transparent rolltop cover + 2 trays (ABS) + 2 tray 39 x 28 cm + 4 coolers, space saving
2 campanas abatibles por ambos lados transparentes + 2 bandejas (ABS) + 2 bandejas de acero
inoxidables 39 x 28 cm + 4 acumuladores de frío, almacenamiento en poco espacio

2 cloches transparentes abattantes 2 côtés + 2 caissons (ABS) + 2 plateaux en acier inox
39 x 28 cm + 4 accumulateurs de froid, peut encombrant à stocker

	cm	↑ cm	Farbe / Colour	€
09200	44 x 32	44		96,00
09202	44 x 32	44		96,00
09204	44 x 32	44		96,00

Kühlakku / cooler / acumulador de frío / accumulateur de froid

	cm	↑ cm	pcs.	€ / set
11101	16 x 7,5	2	4	6,60

Edelstahl-Tablett / stainless steel tray / bandeja de acero inoxidable / plateau inox

	cm	↑ cm	€
90902	39,5 x 28,5	1	9,60



6 tlg.
6 pcs.



09091



09090

Thermo Tablett-Set, 6-teilig

thermo tray, 6 pcs.

bandeja térmica, set de 6

plateau thermique, set de 6



6-teilig:

- 1 Schale
- 1 Edelstahltablett
- 2 Kühlakkus
- 1 transparente Frischhaltehaube
- 1 Transport- und Tragegurt aus Silikon

6 pcs.:

- 1 plastic tray
- 1 stainless steel tray
- 2 coolers
- 1 transparent cover
- 1 silicone transport and carrying strap

set de 6:

- 1 bandeja de plástico
- 1 bandeja de acero inoxidable
- 2 acumuladores de frío
- 1 campana transparente
- 1 correa de silicona para cierre y transporte

set de 6:

- 1 plateau plastique
- 1 plateau en acier inox
- 2 accumulateurs de froid
- 1 cloche transparente
- 1 sangle en silicone pour fermeture et transport

inklusive
Transport- und
Tragegurt!

	cm	↑ cm	Farbe / Colour	€ / set
09091	43 x 29	14		27,00
09090	43 x 29	14		27,00



inklusive 2 Kühlakkus
including 2 coolers



6 tlg.
6 pcs.



09094



09093

Thermo Tablett-Set, 6-teilig

thermo tray, 6 pcs.

bandeja térmica, set de 6

plateau thermique, set de 6



6-teilig:

- 1 Schale
- 1 Edelstahltablett
- 2 Kühlakkus
- 1 transparente Frischhaltehaube
- 1 Transport- und Tragegurt aus Silikon

6 pcs.:

- 1 plastic tray
- 1 stainless steel tray
- 2 coolers
- 1 transparent cover
- 1 silicone transport and carrying strap

set de 6:

- 1 bandeja de plástico
- 1 bandeja de acero inoxidable
- 2 acumuladores de frío
- 1 campana transparente
- 1 correa de silicona para cierre y transporte

set de 6:

- 1 plateau plastique
- 1 plateau en acier inox
- 2 accumulateurs de froid
- 1 cloche transparente
- 1 sangle en silicone pour fermeture et transport

inklusive
Transport- und
Tragegurt!

	cm	↑ cm	Farbe / Colour	€ / set
09094	35	15		27,00
09093	35	15		27,00



inklusive 2 Kühlakkus
including 2 coolers



BEVERAGE DISPENSERS



Getränkespender „INDUSTRIAL“

beverage dispenser
dispensador de bebidas
distributeur de boissons

Black
is
beautiful

GLAS
GLASS

EDELSTAHL
STAINLESS
INOX

METALL

SILIKON
SILICON

NON
SLIP FEET

Behälter aus Glas, Zapfhahn aus Edelstahl, Fuß und Deckel aus Metall, schwarz, Antirutschmatte aus Silikon

glass container, stainless steel tap, base and lid in black metal, silicone non-slip mat
recipiente de vidrio, grifo de acero inoxidable, base y tapa de metal negro, alfombra antideslizante de silicona

réceptien en verre, robinet en acier inox, pied et couvercle en métal noir, tapis antidérapant en silicone

	Ø cm	↑ cm	ltr.		€
10450	20	45	7	inkl. Gestell / incl. stand	94,00



Antirutschmatte aus Silikon
Antirutschmatte aus Silikon



Getränkespender „URBAN“

beverage dispenser
dispensador de bebidas
distributeur de boissons

Black
is
beautiful

GLAS
GLASS

EDELSTAHL
STAINLESS
INOX

METALL

SILIKON
SILICON

NON
SLIP FEET

Behälter aus Glas, Zapfhahn aus Edelstahl, Fuß und Deckel aus Metall, schwarz, Antirutschmatte aus Silikon

glass container, stainless steel tap, base and lid in black metal, silicone non-slip mat
recipiente de vidrio, grifo de acero inoxidable, base y tapa de metal negro, alfombra antideslizante de silicona

réceptien en verre, robinet en acier inox, pied et couvercle en métal noir, tapis antidérapant en silicone

	Ø cm	↑ cm	ltr.		€
10451	22	45	7	inkl. Gestell / incl. stand	94,00



Antirutschmatte aus Silikon
Antirutschmatte aus Silikon



Eiswasserröhre

ice cube cooling tube
tubo enfriador para cubitos
tube pour glaçons

PP
POLYPROPYLEN



	Ø cm	↑ cm	passend für Getränkenspender / fits to drink dispenser	€
10849	11	24	10400, 10403, 10450, 10451, 10855	8,80



7 ltr.

Getränkespender „ELEMENT“

beverage dispenser
dispensador de bebidas
distributeur de boissons



Behälter aus Glas, Zapfhahn aus Edelstahl, Fuß und Deckel aus Beton

glass container, stainless steel tap, stand and lid made of concrete
recipiente de vidrio, grifo de acero inoxidable, soporte y tapa de hormigón
récipient en verre, robinet en acier inox, support et couvercle en béton

	Ø cm	↑ cm	ltr.		€
10400	22	45	7	inkl. Gestell / incl. stand	114,00



7 ltr.

Getränkespender „ASIA“

beverage dispenser
dispensador de bebidas
distributeur de boissons



Behälter aus Glas, Zapfhahn aus Edelstahl, Fuß und Deckel aus Holz

glass container, stainless steel tap, wooden stand and lid
recipiente de vidrio, grifo de acero inoxidable, soporte y tapa de madera
récipient en verre, robinet en acier inox, support et couvercle en bois

	Ø cm	↑ cm	ltr.		€
10403	24,5	45,5	7	inkl. Gestell / incl. stand	94,00

Ersatz-Fuß / base / soporte de recambio / support de remplacement

	Ø cm	↑ cm		€
10404	24,5	15		25,00

Ersatz-Deckel / replacement lid / tapa de recambio / couvercle de rechange

	Ø cm	↑ cm		€
10405	14,0	5		9,60



7 ltr.

Getränkespender „OLD FASHIONED“

beverage dispenser
dispensador de bebidas
distributeur de boissons



Behälter aus Glas, Zapfhahn aus Edelstahl, Gestell schwarz

glass container, stainless steel tap, black stand
recipiente de vidrio, grifo de acero inoxidable, soporte negro
récipient en verre, robinet en acier inox, support noir

	Ø cm	↑ cm	ltr.		€
10409	27	50,5	7	inkl. Gestell / incl. stand	82,00

Ersatz-Gestell / stand / soporte de recambio / support de remplacement

	Ø cm	↑ cm		€
10410	27	31,5		15,40

Ersatz-Glas / replacement glass / cristal de recambio / vitre de rechange

	Ø cm	↑ cm	ltr.	€
10411	19	36,5	7	46,00

Ersatz-Zapfhahn 10409 / replacement tap for 10409

		€
10718		26,00



10853

Tropfenschale, 2-teilig

drip tray, 2 pcs.
aros anti-goteo, set de 2
anneaux coupe-gouttes, set de 2



	Ø cm	↑ cm	Farbe / Colour	€
10851	9,5	1,5	White	7,40
10853	9,5	1,5	Black	7,40

BEVERAGE DISPENSERS



Getränkespender

beverage dispenser
dispensador de bebidas
distributeur de boissons



Behälter aus Glas, Zapfhahn aus Edelstahl, Deckel aus Edelstahl

glass container, stainless steel tap, lid in stainless steel
recipiente de vidrio, grifo de acero inoxidable, tapa de acero inoxidable
récipient en verre, robinet en acier inox, couvercle en acier inox

	Ø cm	↑ cm	ltr.	€
10855	20	30,5	7	74,00



Getränkespender „FRUITS“

beverage dispenser
dispensador de bebidas
distributeur de boissons



Behälter aus Glas, Zapfhahn aus Edelstahl, Gestell schwarz

glass container, stainless steel tap, black stand
recipiente de vidrio, grifo de acero inoxidable, soporte negro
récipient en verre, robinet en acier inox, support noir

	Ø cm	↑ cm	ltr.	€
10415	25	58	10,5	inkl. Gestell / incl. stand 90,00

Trinkglas „BEACH“

drinking glass / vaso / verre



	Ø cm	↑ cm	ltr.	VE	€ / pc.
10505	8,5	13,5	0,3	48	4,20

Ersatzteile Getränkspender „FRUITS“

spare parts beverage dispenser
recambios dispensador de bebidas
pièces distributeur de boissons



Ersatz-Deckel / replacement glass / cristal de recambio / vitre de rechange

	Ø cm	↑ cm	€
10418	14	12	9,70

Ersatz-Glas inklusive Deckel, ohne Zapfhahn / replacement glass with lid without tap / cristal de recambio con tapa sin grifo / vitre de rechange avec couvercle sans robinet

	Ø cm	↑ cm	ltr.	€
10417	25	42	10,5	38,00

Ersatz-Zapfhahn / replacement tap / grifo de recambio / robinet de rechange



	€
10718	26,00

Ersatz-Gestell / stand / soporte de recambio / support de remplacement



	Ø cm	↑ cm	€
10416	26	19	26,00



4,5 ltr.

300 ml



4,5 ltr.

Getränkespender „FRESH WOOD“

beverage dispenser
dispensador de bebidas
distributeur de boissons



Behälter mit Edelstahlzapfhahn und Korkdeckel, stabiles Glas, inklusive Holzstandfuß und Kork-Untersetzer

container with stainless steel tap and cork cover, solid glas, including wooden base and cork coaster

recipiente con grifo de acero inoxidable y tapa de corcho, cristal sólido, pie de madera y posavasos de corcho

réceptient avec robinet en acier inox et covercle de liège, verre robuste, pied en bois et soucoupes de liège

	cm	↑ cm	ltr.	€
10430	23 x 23	56,5	4,5	100,00

Trinkbecher „CRYSTAL“
drinking cup / vaso / gobelet



	Ø cm	↑ cm	ltr.	VE	€ / pc.
10501	8	12,5	0,3	48	4,10

Tropfenschale / drip tray / aro anti-goteo / anneau coupe-gouttes



	Ø cm	↑ cm	Farbe / Colour	€
10851	9,5	1,5	White	7,40

Ersatzteile Getränkspender „FRESH WOOD“

spare parts beverage dispenser
recambios dispensador de bebidas
pièces distributeur de boissons

Ersatz-Deckel / replacement lid / tapa de recambio / couvercle de rechange

	Ø cm	↑ cm	Farbe / Colour	€
10428	11,5	1,5	Orange	5,50

Ersatz-Glas inklusive Zapfhahn / replacement glass with tap / cristal de recambio con grifo / vitre de rechange avec robinet

	Ø cm	↑ cm	ltr.	€
10422	15,5	42,0	4,5	52,00

Ersatz-Untersetzer aus Kork / replacement cork coaster / posavasos de corcho de recambio / soucoupes de liège de rechange

	Ø cm	↑ cm	€
10424	16,5	1,5	5,50

Ersatz-Gestell / stand for / soporte de recambio / support de remplacement

	cm	↑ cm	Farbe / Colour	€
10426	23 x 23	14	Orange	21,80

BEVERAGE DISPENSERS



Getränkespender „NORDIC WOOD“

beverage dispenser
dispensador de bebidas
distributeur de boissons



Behälter mit Edelstahlzapfhahn und Holzdeckel, stabiles Glas, inklusive weißem Holzstandfuß und Kork-Untersetzer

container with stainless steel tap and wooden cover, solid glass, including white wooden base and cork coaster

recipiente con grifo de acero inoxidable y tapa de madera, cristal sólido, pie de madera blanca y posavasos de corcho

réipient avec robinet en acier inox et couvercle en bois, verre robuste, pied en bois blanc et soucoupes de liège

	cm	↑ cm	ltr.	€
10435	23 x 23	60,5	7,5	100,00

Trinkbecher „CRYSTAL“
drinking cup / vaso / gobelet



	Ø cm	↑ cm	ltr.	VE	€ / pc.
10501	8	12,5	0,3	48	4,10

Ersatzteile Getränkspender „NORDIC WOOD“

parts beverage dispenser
recambios dispensador de bebidas
pièces distributeur de boissons

Ersatz-Deckel / replacement lid / tapa de recambio / couvercle de rechange

	Ø cm	↑ cm	€
10428	11,5	1,5	5,50

Ersatz-Glas inklusive Zapfhahn / replacement glass with tap / cristal de recambio con grifo / vitre de rechange avec robinet

	Ø cm	↑ cm	ltr.	€
10427	17	46	7,5	54,00

Ersatz-Untersetzer aus Kork / replacement cork coaster / posavasos de corcho de recambio / soucoupes de liège de rechange

	Ø cm	↑ cm	€
10424	16,5	1,5	5,50

Ersatz-Gestell / stand for / soporte de recambio / support de remplacement

	cm	↑ cm	Farbe / Colour	€
10426	23 x 23	14		21,80



Saftdispenser „TOP FRESH“

juice dispenser
dispensador de zumo
distributeur à jus de fruit



hochglanzpoliert, Kühlung durch 2 Kühlakkus von oben und unten
mirror polished, cooling with 2 cooling elements from the top and base

pulido brillante, con 2 acumuladores de frío, 1 arriba y 1 en la base
poli brillante, 2 accumulateurs de froid, 1 dans le couvercle, 1 dans le socle

	cm	↑ cm	ltr.	€
10800	21 x 32	43	4	248,00
10700	23 x 35	52	6	350,00



Saftdispenser DUO „TOP FRESH“

juice dispenser
dispensador de zumo
distributeur à jus de fruit



hochglanzpoliert, Kühlung durch 2 Kühlakkus von oben und unten

mirror polished, cooling with 2 cooling elements from the top and base

pulido brillante, con 2 acumuladores de frío, 1 arriba y 1 en la base
poli brillante, 2 accumulateurs de froid, 1 dans le couvercle, 1 dans le socle

	cm	↑ cm	ltr.	€
10720	42 x 32	52	2 x 6	514,00



Saftdispenser „INOX STAR“

juice dispenser
dispensador de zumo
distributeur à jus de fruit



Edelstahl-Crushed Ice Röhre herausnehmbar

removable stainless steel crash ice tube
con tubo inox refrigerante extraíble para hielo picado
avec tube inox réfrigérant amovible pour glace pilée

	cm	↑ cm	ltr.	€
10795	36 x 26	55	8	190,00

Behälter / container / recipiente / récipient

	Ø cm	ltr.	€
10796	22	8	35,70



Iso-Dispenser

insulated dispenser
dispensador isotérmico
distributeur de boisson isothermique



für heiße und kalte Getränke

for hot and cold drinks
para bebidas frías y calientes
pour boissons chaudes ou froides

	Ø cm	↑ cm	ltr.	€
10788	24	42	9,5	62,00

Hahn / tap / grifo / robinet

	€
10789	12,00

einklappbare Füße
foldable feet

9,5 ltr.

BEVERAGE DISPENSERS



1) Deckel / cover / tapa / couvercle		
für ltr. / for ltr. / para ltr. / pour ltr.		
		€
10701	6	27,00
10801	4	23,00

2) Kühlakku / cooler / acumulador de frío / accumulateur de froid		
für ltr. / for ltr. / para ltr. / pour ltr.		
		€
10777	4 / 6	5,40

3) Behälter inklusive Zapfhahn / container incl. tap recipiente con grifo / récipient avec robinet		
für ltr. / for ltr. / para ltr. / pour ltr.		
		€
10703	6	178,00
10803	4	152,00

3) Behälter ohne Zapfhahn / container without tap recipiente sin grifo / récipient sans robinet		
für ltr. / for ltr. / para ltr. / pour ltr.		
		€
10704	6	134,00
10804	4	112,00

4) Non-Drip Hahn / non-drip tap / grifo anti-goteo / robinet anti-goutte		
für ltr. / for ltr. / para ltr. / pour ltr.		
		€
10707	6	53,00
10807	4	52,00

5) Dichtungsring / sealing ring / arandela / rondelle		
für ltr. / for ltr. / para ltr. / pour ltr.		
		€
10608	4 / 6	1,60

6) Einsatz / insert / aro inox / cercle inox		
für ltr. / for ltr. / para ltr. / pour ltr.		
		€
10708	6	4,40
10808	4	4,40

7) Standfuß 18/10 Edelstahl / column 18/10 stainless steel base inox 18/10 / socle inox 18/10		
für ltr. / for ltr. / para ltr. / pour ltr.		
		€
10709	6	74,00
10809	4	56,00

8) Tropfgitter 18/10 Edelstahl / drip lattice 18/10 stainless steel rejilla recoge gotas 18/10 / grille ramasse-gouttes 18/10		
für ltr. / for ltr. / para ltr. / pour ltr.		
		€
10712	6	26,00
10713	DUO	46,00
10812	4	23,00

9) Bodenplatte 18/10 Edelstahl / footing 18/10 stainless steel base de 18/10 acero / socle inox 18/10		
für ltr. / for ltr. / para ltr. / pour ltr.		
		€
10710	6	51,00
10711	DUO / 6 + 6	108,00
10814	4	35,00

1x Dichtung, 2x Dichtungsring (transparent), 1x Dichtungsring (s / w)
1x seal, 2x sealing ring (transparent), 1x sealing ring (b / w)

Zubehör / Reinigungsset - für die regelmäßige Reinigung		
€		
10714	für Zapfhahn 10707	4,20
10715	für Zapfhahn 10807	4,20
10716	für Zapfhahn 10907	5,60
10717	für Zapfhahn 10867	5,60





Der Adapter passt auf alle Dispenser der Serien TOP FRESH, BRIDGE und SUNDAY und kann ganz einfach installiert werden.

The adapter fits all dispensers of the series TOP FRESH, BRIDGE and SUNDAY and can be installed very easily.

El adaptador se adapta a todos los dispensadores de las series TOP FRESH, BRIDGE y SUNDAY y puede ser instalado fácilmente.

L'adaptateur s'adapte à tous les distributeurs des séries TOP FRESH, BRIDGE et SUNDAY et peut être installé très facilement.

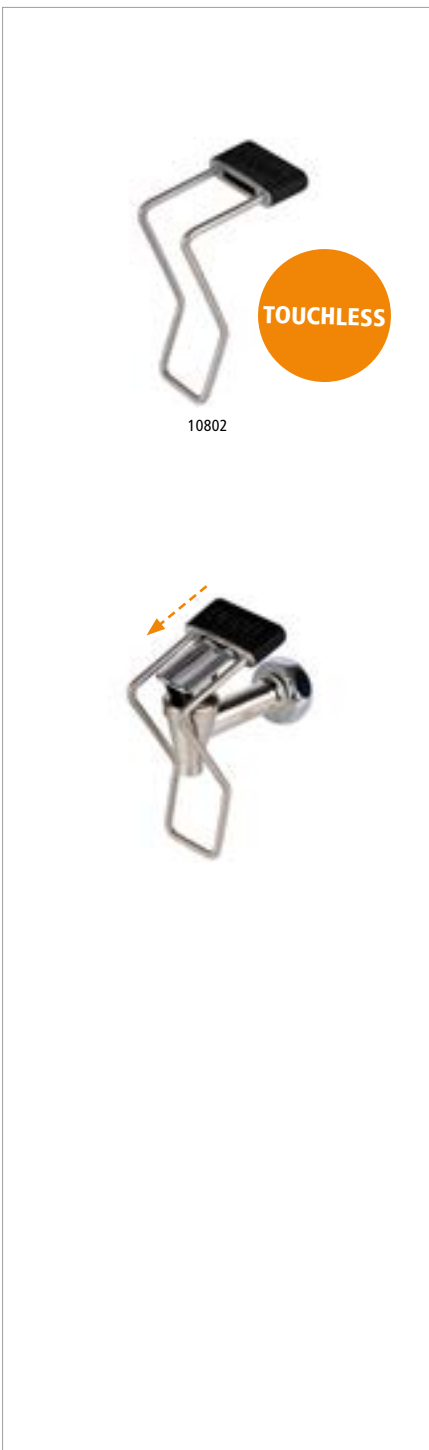

Adapter „TOP FRESH“

adapter
adaptador
adaptateur



handkontaktloser Adapter, einfach zu installieren
adapter touchless for tap, easy to install
adaptador sin contacto para grifo
adaptateur sans contact manuel, facile à installer

	cm	↑ cm	€
10802	12 x 4,5	5,5	10,00



Einfach den Adapter an der dafür vorgesehenen Öffnung auf den Hebel des Zapfhahns stecken.

Simply plug the adapter onto the lever of the tap at the opening provided.

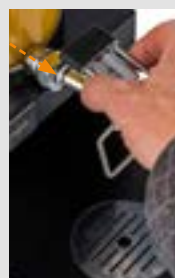

Anschließend den Adapter nach unten festziehen. Durch das Nach-Vorne-Drücken des unteren Edelstahlbügels mit Hilfe des Glases, wird der Hebel des Zapfhahns betätigt und das Getränk fließt völlig handkontaktlos in das Glas.

Then tighten the adapter downwards. By pushing the lower stainless steel bracket forward with the help of the glass, the lever of the tap is activated and the drink flows into the glass completely without hand contact.

passend für / suitable for:



Saftdispenser „TOP FRESH“
Katalog Seite 46
juice dispenser,
catalogue page 46



Milchkanne „TOP FRESH“
Katalog Seite 51
milk dispenser,
catalogue page 51



Saftdispenser „BRIDGE“
Katalog Seite 20
juice dispenser,
catalogue page 20

BEVERAGE DISPENSERS



Saftdispenser „TOWER“

juice dispenser
dispensador de zumo
distributeur à jus de fruit

aus Edelstahl, inklusive Crushed Ice Röhre

made of stainless steel, inclusive crushed ice tube
de acero inoxidable con tubo para hielo picado
en acier inox avec tube de glace pilée



5 ltr.

	cm	↑ cm	ltr.	€
10440	35 x 23	75	5	330,00



Edelstahl Zapfhahn
stainless steel tap



Milchdispenser „BRIDGE“

milk dispenser
dispensador de leche
distributeur à lait

massives Buchenholz gebeizt, Edelstahldispenser mit 1 Kühlakku im Standfuß inklusive touchless adapter

solid beech wood, stained, stainless steel dispenser with 1 cooler in stand including touchless adapter

madera de haya maciza teñida, dispensador de acero inoxidable con 1 acumulador de frío en la base y con adaptador sin contacto para grifo

bois de hêtre massif teinté, distributeur en acier inox avec 1 accumulateur de froid dans le socle et avec adaptateur sans contact manuel



	cm	↑ cm	ltr.	Farbe / Colour	€
10837	31 x 20	39	3	■	279,00
10839	39 x 22	45	5	■	444,00



Milchdispenser „BRIDGE“

milk dispenser
dispensador de leche
distributeur à lait

massives Ahornholz, Edelstahldispenser mit 1 Kühlakku im Standfuß inklusive touchless adapter

solid maple wood, stainless steel dispenser with 1 cooler in stand including touchless adapter
madera maciza de arce, dispensador de acero inoxidable con 1 acumulador de frío en la base y con adaptador sin contacto para grifo

bois d'érable massif, distributeur en acier inox avec 1 accumulateur de froid dans le socle et avec adaptateur sans contact manuel



	cm	↑ cm	ltr.	Farbe / Colour	€
10836	31 x 20	39	3	■	279,00
10838	39 x 22	45	5	■	444,00



Saftdispenser „BRIDGE“

juice dispenser
dispensador de zumo
distributeur à jus



Kühlung durch 2 Kühllakkus von oben und unten

cooling with 2 coolers from the top and base

2 acumuladores de frío: 1 en la base y 1 en la tapa

2 accumulateurs de froid: 1 dans le couvercle, 1 dans le socle

	cm	↑ cm	ltr.	Farbe / Colour	€
10872	31,0 x 20	42	4		239,00
10873	35,5 x 22	50	6		279,00



inklusive 3 Magnetschilder: ORANGE, APPLE, GRAPEFRUIT
including 3 magnetic signs: ORANGE, APPLE, GRAPEFRUIT



Saftdispenser „BRIDGE“

juice dispenser
dispensador de zumo
distributeur à jus



Kühlung durch 2 Kühllakkus von oben und unten

cooling with 2 coolers from the top and base

2 acumuladores de frío: 1 en la base y 1 en la tapa

2 accumulateurs de froid: 1 dans le couvercle, 1 dans le socle

	cm	↑ cm	ltr.	Farbe / Colour	€
10870	31,0 x 20	42	4		239,00
10871	35,5 x 22	50	6		279,00



inklusive 3 Magnetschilder: ORANGE, APPLE, GRAPEFRUIT
including 3 magnetic signs: ORANGE, APPLE, GRAPEFRUIT



Milchkanne „TOP FRESH“

milk dispenser
dispensador de leche
distributeur à lait



hochglanzpoliert, 1 Kühllakku im Standfuß, „original Milchkanne mit Henkel“

mirror polished, 1 cooler in base, original milkcan

pulido brillante, 1 acumulador de frío en la base, recipiente „lechera“

poli brillant, 1 accumulateur de froid dans le socle, design „pot à lait“

	cm	↑ cm	ltr.	€
10830	21 x 32	39	3	320,00
10750	23 x 35	45	5	510,00

Milchkanne ohne Zapfhahn / milkcan without tap / jarra de leche sin grifo / récipient à lait sans robinet

	Ø cm	↑ cm	ltr.	€
10833	16	22	3	174,00
10663	22	26	5	210,00

BEVERAGE DISPENSERS



Milchkanne „TOP FRESH“

milk dispenser
dispensador de leche
distributeur à lait



inklusive Porzellanschild zum Beschriften, 1 Kühlakku im Fuß

including porcelain sign, 1 cooler in base
incluye cartelito en porcelana, 1 acumulador de frío en la base
indicateur en porcelaine inclus, 1 accumulateur de froid dans le socle

	cm	↑ cm	ltr.	€
10850	31 x 21	42	4	300,00



Milchkanne „TOP FRESH“

milk dispenser
dispensador de leche
distributeur à lait



Buchenholz versiegelt, inklusive Porzellanschild zum Beschriften, 1 Kühlakku im Fuß

beech wood, waterproof, incl. porcelain sign, 1 cooler in base
madera de haya, resistente al agua, incluye placa de porcelana, 1 acumulador de frío en la base
socle bois hêtre traité, indicateur en porcelaine inclus, 1 accumulateur de froid dans le socle

	cm	↑ cm	ltr.	€
10840	23 x 32,0	42	4	300,00
10757	27 x 38,5	45	8	352,00

Milchkanne Porzellan, ohne Zapfhahn / milkcan porcelain, without tap / jarra de leche sin grifo / récipient en porcelaine sans robinet

	Ø cm	↑ cm	ltr.	€
10825	18	25	4	90,00
10758	22	26	8	110,00

Deckel für 10840, 10850 / cover for 10840, 10850 / tapa para 10840, 10850 / couvercle pour 10840, 10850

	€
10859	7,80

Deckel für 10757 / cover for 10757 / tapa para 10757 / couvercle pour 10757

	€
10759	15,40

Schild und Kette / shield and chain / placa y cadena / indicateur porcelaine avec chaînette

	€
10756	5,50

Zapfhahn / tap / grifo / robinet

	€
10907	35,00



Kaffeedispenser „HAPPY HOUR“

coffee dispenser
dispensador de café
distributeur de café



hochglanzpoliert, für warme Getränke, stabil und standfest, inklusive 1 Brennpastenbehälter
mirror polished, for warm drinks, solid and stable, including 1 burner holder
pulido brillante, para bebidas calientes, sólido y estable, incluye un calentador
poli brillant, pour boissons chaudes, robuste et stable, avec 1 brûleur

	cm	↑ cm	ltr.	€
11672	31 x 33,5	54,5	10,5	210,00

Hahn / tap / grifo / robinet

	€
11671	27,00

Elektro-Heizelement / heating unit / resistencia / résistance

	cm	↑ cm	€
12287	21 x 20	6	99,00



Pump-Isolierkanne „PREMIUM“

air pot
jarra termo
bouteille isotherme



matt poliert, doppelwandig, Tragegriff, Drehverschluss, Pumpmechanismus, Füllstandsanzeigefür heiße und kalte Getränke, inklusive 4 Beschriftungsclips, für 24 Tassen

matt polished, double-walled, carrying handle, screw cap, pump mechanism, fill level indicator, for hot and cold beverages, including 4 beverage signs, for 24 cups

pulido mate, doble pared, asa de transporte, tapón de rosca, mecanismo de bombeo, indicador de nivel para bebidas calientes y frías, con 4 clips para marcar, para 24 tazas

poli mat, double paroi, poignée de transport, fermeture rotative, mécanisme de pompage, indicateur de niveau pour boissons chaudes et froides, avec 4 clips d'inscriptions, pour 24 tasses

	Ø cm	↑ cm	ltr.	Anzahl der Tassen	€
10916	15	37	3	24	70,00

Tropfenfänger für Pump-Isolierkanne / drip tray for air pot / recogegotas para jarra termo / ramasse-gouttes pour bouteilles isotherme

	cm	↑ cm	€
10917	24 x 18,5	4	11,40



Pump-Isolierkanne „BUDGET“

air pot
jarra termo
bouteille isotherme



Edelstahl, Polypropylen, matt poliert, doppelwandig, Tragegriff, Dreh-Pumpknopf, für heiße und kalte Getränke, für 17 Tassen

stainless steel, polypropylene, matt polished, double-walled, carrying handle, push-button, for hot and cold beverages, for 17 cups

acero inoxidable, polipropileno, pulido mate, doble pared, asa de transporte, botón giratorio de la bomba, para bebidas calientes y frías, para 17 tazas

acier inox, polypropylène, poli mat, double paroi, poignée de transport, bouton de pompage rotatif, pour boissons chaudes et froides, pour 17 tasses

	Ø cm	↑ cm	ltr.	Anzahl der Tassen	€
10915	13,5	32,5	2,2	17	28,00

VACUUM JUGS



Isolierkanne „ADVANCED“

vacuum jug
jarra termo
bouteille isotherme



doppelwandig, spülmaschinenfest, Einhandautomatik, aufgeklappt passt die Kanne unter die gängigen Kaffeeautomaten, für heiße und kalte Getränke

double-walled, dishwasher-safe, easy pouring system, with flipped-back lid, the air pot fits under a wide range of coffee makers, for hot and cold beverages

doble pared, resistente al lavavajillas, se maneja con 1 mano, con la tapa abierta la jarra se puede usar con casi todas las cafeteras corrientes, para bebidas frías y calientes

double paroi, résistante au lave-vaisselle, usage à 1 main, avec la couvercle ouverte a bouteille se peut user avec toutes les machines à café courantes, pour boissons chaudes ou froides

	Ø cm	↑ cm	ltr.	Anzahl der Tassen	€
10921	10,5	13,0	0,3	2,5	45,00
10922	10,5	18,0	0,6	5,0	52,00
10923	13,0	19,5	1,0	8,0	58,00
10924	13,0	23,5	1,5	12,0	65,00



Deckel klappbar
lid foldable



Schutzmantel „HOT WATER“

protective coat
funda protectora
housse de protection



aus braunem Kunstleder, mit Kennzeichnung „HOT WATER“
made of brown imitation leather, with marking „HOT WATER“
imitación cuero marrón, can marcaje „HOT WATER“
en similibucir marron, avec marquage „HOT WATER“



	cm	↑ cm	Farbe / colour	fits to	€
10925	16 x 16	1	■	10922	14,00
10927	20 x 20	1	■	10924	15,40



Schutzmantel „BLACK COFFEE“

protective coat
funda protectora
housse de protection



aus schwarzem Kunstleder, mit Kennzeichnung „BLACK COFFEE“
made of black imitation leather, with marking „BLACK COFFEE“
imitación cuero negro, can marcaje „BLACK COFFEE“
en similibucir noir, avec marquage „BLACK COFFEE“



	cm	↑ cm	Farbe / colour	fits to	€
10926	16 x 16	1	■	10922	14,00
10928	20 x 20	1	■	10924	15,40



Isolierkanne „VEGAN ADVANCED“

vacuum jug
jarra termo
bouteille isotherme

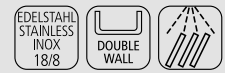

doppelwandig, spülmaschinenfest, Einhandautomatik, aufgeklappt passt die Kanne unter die gängigen Kaffeautomaten, für heiße und kalte Getränke, mit Gravur „VEGAN“

double-walled, dishwasher-safe, easy pouring system, with flipped-back lid, the air pot fits under a wide range of coffee makers, for hot and cold beverages, with engraving „VEGAN“
doble pared, resistente al lavavajillas, se maneja con 1 mano, con la tapa abierta la jarra se puede usar con casi todas las cafeteras corrientes, para bebidas frías y calientes, con grabado „VEGAN“
double paroi, résistante au lave-vaisselle, usage à 1 main, avec la couvercle ouverte a bouteille se peut user avec toutes les machines à café courantes, pour boissons chaudes ou froides, avec gravure „VEGAN“

	Ø cm	↑ cm	ltr.	Anzahl der Tassen	€
10353	10,5	18,0	0,6	5,0	53,00
10354	13,0	19,5	1,0	8,0	59,00



Isolierkanne „CLASSIC“

vacuum jug
jarra termo
bouteille isotherme



doppelwandig, Einhandautomatik, Drehverschluss, für heiße und kalte Getränke, mit Gravur „VEGAN“
double-walled, easy push-button pouring system, screw cap, for hot and cold drinks, with engraving „VEGAN“

doble pared, se maneja con 1 mano, con tapa a rosca, para bebidas frías y calientes, con grabado „VEGAN“
double paroi, usage à 1 main, couvercle à visser, pour boissons chaudes ou froides, avec gravure „VEGAN“

	Ø cm	↑ cm	ltr.	Anzahl der Tassen	€
10910	14	19	1,0	8	17,20
10911	14	22	1,5	12	19,00
10912	14	25	2,0	16	22,00



Isolierkanne „VEGAN CLASSIC“

vacuum jug
jarra termo
bouteille isotherme



doppelwandig, Einhandautomatik, Drehverschluss, für heiße und kalte Getränke
double-walled, easy push-button pouring system, screw cap, for hot and cold drinks

doble pared, se maneja con 1 mano, con tapa a rosca, para bebidas frías y calientes
double paroi, usage à 1 main, couvercle à visser, pour boissons chaudes ou froides

	Ø cm	↑ cm	ltr.	€
10352	14	19	1,0	21,00



Isolierkanne „ECONOMY“

vacuum jug
jarra termo
bouteille isotherme



robuste Umhüllung mit Polypropylen-Kunststoff, Stabilglaseinsatz, Drehverschluss mit Drucktasten-Bedienung für heiße und kalte Getränke, 8 Tassen

double-walled with glass liner, screw cap with easy push-button pouring system, for hot and cold beverages, 8 cups

exterior de plástico polipropileno, interior aislante de vidrio, con tapa a rosca con cierre dosificador para bebidas frías y calientes, 8 tazas

extérieur en plastique polypropylène, intérieur avec plaque de verre, couvercle à visser, pour boissons chaudes ou froides, 8 tasses

	Ø cm	↑ cm	ltr.	Farbe / Colour	€
10913	16	20	1	White	17,40
10914	16	20	1	Black	17,40

CARAFES



**3 tlg.
3 pcs.**

1,4 ltr.

Kühlkaraffe, 3-teilig „COOL“

cooling carafe, 3 pcs.

jarra fría, set de 3

pichet rafraîchisseur, set de 3

1 Glaskaraffe mit Edelstahl Ausgießer, öffnet und schließt selbstständig
+ 1 verchromter Fuß + 1 Kühllakku, werden bis zu 4 Stunden gekühlt

1 glass carafe with stainless steel pourer, open / closing autonomous
+ 1 chrome plated base + 1 cooling pack, up to 4 hours cooled beverages

1 botella de vidrio con vertedor inox, con autocierre + 1 base cromada + 1 acumulador de frío
que mantiene las bebidas frescas hasta unas 4 horas

1 pichet en verre avec insert verseur inox, fermeture automatique + 1 socle chromé +
1 accumulateur de froid pour maintenir les boissons froides jusqu'à 4 heures



	Ø cm	↑ cm	ltr.	€
10762	16	27	1,4	34,00



Edelstahlausgießer
stainless steel pourer



Kühlstation inklusive Kühllakku (schwarz)
including cooler (black)

1,0 ltr.

Glaskaraffe

glass carafe

jarra de vidrio

pichet en verre

der Deckel öffnet sich beim Ausgießen automatisch

cover opens automatically while pouring

la tapa se abre automáticamente durante el vertido

le couvercle s'ouvre seul pendant le service



	Ø cm	↑ cm	ltr.	€
10766	9,5	29	1	25,00

1,5 ltr.

Saft- / Wasserkanne

juice / water pitcher

jarra de zumo / agua

pichet à eau ou jus de fruit

Deckel aus Edelstahl matt poliert, Ausgießer für tropffreies Ausgießen

stainless steel cover, matt polished, spout for drip-free pouring

tapa de acero inoxidable pulido mate, pico para verter sin gotear

couvercle en acier inox poli mat, bec verseur pour verser sans goutter



	Ø cm	↑ cm	ltr.	€
10764	9,5	27	1,5	26,40



1,5 ltr.

Glaskaraffe
glass carafe
jarra de vidrio
carafe en verre



Deckel aus Edelstahl matt poliert, mit integriertem Auffangsieb für Kerne oder Eis
lid made of matt polished stainless steel, with integrated strainer for cores or ice
tapa de acero inoxidable pulido mate, con filtro integrado para los huesos o el hielo
couvercle en acier inox poli mat, avec filtre intégré pour les pépins ou la glace

	Ø cm	↑ cm	ltr.	€
10792	10	26	1,5	22,00



Deckel mit Doppelfunktion
lid with double function

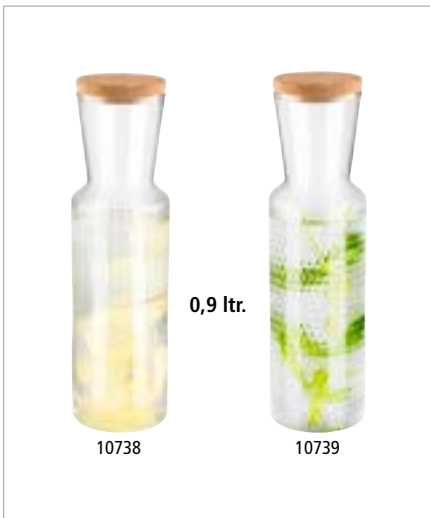

0,9 ltr.

10738

10739

Glaskaraffe
glass carafe
jarra de vidrio
carafe en verre



	Ø cm	↑ cm	ltr.	Design	€
10738	8	27	0,9	LINES	22,00
10739	8	27	0,9	DOTS	22,00



Detailansicht
detail view „LINES“

Detailansicht
detail view „DOTS“

inklusive Korkdeckel
incl. cork cover



0,8 ltr.

10741

10742

Glaskaraffe
glass carafe
jarra de vidrio
carafe en verre



	Ø cm	↑ cm	ltr.	Design	€
10741	8	28	0,8	COMB	21,00
10742	8	28	0,8	DIAMOND	21,00



Detailansicht
detail view „COMB“

Detailansicht
detail view „DIAMOND“

inklusive Holzkorken mit Silikondichtung
including wooden cork with silicone gasket



1,0 ltr.

10721

Glaskaraffe
glass carafe
jarra de vidrio
carafe en verre



Deckel aus Edelstahl matt poliert, Ausgießer für tropffreies Ausgießen
lid made of matt polished stainless steel, spout for drip-free pouring
tapa de acero inoxidable pulido mate, pico para verter sin gotear
couvercle en acier inox poli mat, bec verseur pour verser sans goutter

	Ø cm	↑ cm	ltr.	€
10721	8	25	1,0	16,00
10722	8	32	1,3	18,20

CARAFES



Glaskaraffe „OLD FASHIONED“, 2 teilig

glass carafe, 2 pcs.
jarra de vidrio, set de 2
carafe en verre, set de 2

1 Flasche 1,0 ltr., 1 Glas 0,3 ltr.
1 bottle 1,0 ltr., 1 glass 0,3 ltr.
1 botella 1,0 ltr., 1 vaso 0,3 ltr.
1 bouteille 1,0 ltr., 1 verre 0,3 ltr.



	Ø cm	↑ cm	ltr.	€
10690	9,5	31	1,0	15,90

Ersatzglas / replacement glass / vaso de recambio / verre de remplacement

	Ø cm	↑ cm	ltr.	VE / unit	€ / pc.
10520	8	12,5	0,3	6	2,10



Glaskaraffe „OLD FASHIONED“

glass carafe
jarra de vidrio
carafe en verre



Deckel mit Auffangsieb für Kerne oder Eis
lid with integrated strainer for cores or ice
tapa con filtro integrado para los huesos o el hielo
couverture avec filtre intégré pour les pépins ou la glace

	Ø cm	↑ cm	ltr.	€
10691	12	26	1,8	13,90



Buffetbrett

buffet board
tabla de buffet
planche de buffet



für Karaffen, mit 3 Einsätzen Ø 11 cm aus Kunstleder, aus geöltem Eichenholz

for carafes, with 3 leatherette inserts Ø 11 cm, made of oiled oak wood
para jarras, con 3 inserciones de imitación de cuero Ø 11 cm, de madera de roble aceitada
pour pichets, avec 3 inserts en cuir synthétique Ø 11 cm, en bois de chêne huilé

	cm	↑ cm	Farbe / Colour	€
11705	47 x 19	2	natural oak	82,00
11706	47 x 19	2	dark oak	82,00

6 Einsätze aus Kunstleder / 6 leatherette inserts / 6 inserciones de imitación de cuero / 6 inserts en cuir synthétique

	Ø cm	Farbe / Colour	pcs.	€ / set
35716	11	anthracite	6	17,40



Kunstledereinsatz herausnehmbar
removable leatherette insert



Saft- / Wasserkanne

juice / water pitcher
jarra de zumo / agua
pichet à eau ou jus de fruit

mit Eiswasserröhre
with water ice tube
con tubo para hielo
avec tube à glaçons plongeant pour réfrigérer



	Ø cm	↑ cm	ltr.	€
10770	18	29	3	29,60



2,0 ltr.

Soft- / Wasserkanne
juice / water pitcher
jarra de zumo / agua
pichet à eau ou jus de fruit



	Ø cm	↑ cm	ltr.	€
10775	12	26	2	24,00



2,5 ltr.

Soft- / Wasserkanne
juice / water pitcher
jarra de zumo / agua
pichet à eau ou jus de fruit



	Ø cm	↑ cm	ltr.	€
10776	14	29	2,5	23,00



Flaschenverschluss
bottle top

10748 1 ltr.

10749 1 ltr.

Flasche „STRIPES“
bottle
botella
bouteille



	Ø cm	↑ cm	ltr.	Farbe / colour	€
10748	9	28,5	1		12,80
10749	9	28,5	1		12,80



2,8 ltr.

Soft- / Wasserkanne
juice / water pitcher
jarra de zumo / agua
pichet à eau ou jus de fruit
mit Eiswasserröhre
with water ice tube
con tubo para hielo
avec tube à glaçons plongeant pour réfrigérer



	cm	↑ cm	ltr.	€
10769	19 x 13	27	2,8	25,00



1,6 ltr.

Karaffe
bottle
botella
bouteille



Schraubdeckel mit aromadichtem Verschluss
screwed lid, aroma-tight
tapón de rosca, impide la fuga de aromas
bouchon à visser, ne laisse pas passer les arômes

	Ø cm	↑ cm	ltr.	Farbe / Colour	€
10771	11	30	1,6		16,00

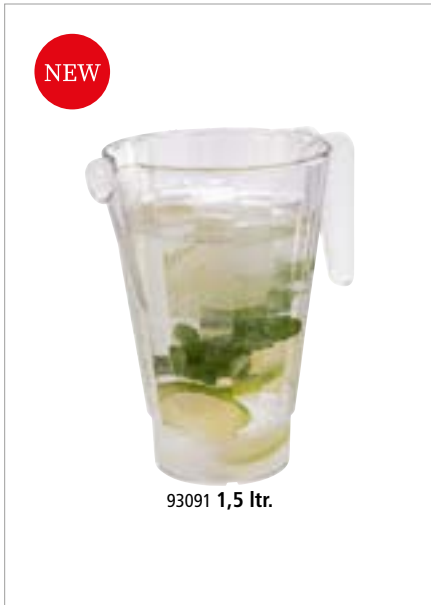

93091 1,5 ltr.

Pitcher
pitcher
jarra
pichet



	Ø cm	↑ cm	ltr.	€
93090	12,5	17,5	1,0	9,00
93091	13,5	20,0	1,5	10,00

passende Deckel / fitting lids / tapa adecuadas / couvercles appropriées

	cm	↑ cm	fits to	€
93092	13,0	1,5	93090	2,00
93093	14,0	1,5	93091	2,00

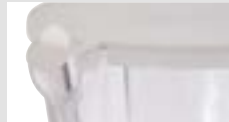

Deckel mit Klappe
lid with flap



einfaches Eingießen
easy pouring



stapelbar
stackable



1,5 ltr.

Pitcher
pitcher
jarra
pichet



	Ø cm	↑ cm	ltr.	€
93105	13	21	1,5	10,40



Kühlbox „FROSTY“
bottle cooler
enfriador de botellas
rafraichisseur de bouteilles



mit herausnehmbarem Einsatz für 4 Flaschen
with removable insert for 4 bottles
con inserto extraíble para 4 botellas
avec insert amovible pour 4 bouteilles



Abb. ohne Einsatz
illustration without insert

	cm	↑ cm	ltr.	hole ø cm	€
93230	27 x 27	15	7,5	11	37,00



7,5 Liter



NEW

Flaschenkühler „BIG BOWL“
bottle cooler
enfriador de botella
rafraichisseur de bouteille



gehämmerte Oberfläche, innen mattiert, herausnehmbarer Tropfeinsatz
hammered surface, matted inside, removable drip tray
superficie martillada, interior mate, bandeja de goteo extraíble
surface martelée, intérieur mat, bac de récupération amovible

	Ø cm	↑ cm	ltr.	€
36130	37	23	8	240,00





36111 7 ltr.

36112 7 ltr.

Wein- / Sektkühler „XL“

wine / champagne bowl
cubitera para vino y cava
seau à vin ou champagne

gehämmerte Oberfläche, mit 2 seitlichen Eingriffen

hammered surface, with 2 handles on the side

superficie martillada, con 2 asas

surface martelée, avec 2 poignées



	cm	↑ cm	ltr.	Farbe / Colour	€
36111	30 x 23,5	23	7	copper-look	62,00
36112	30 x 23,5	23	7	gunmetal-look	62,00



NEW

36109 3,9 ltr.

36108 3,9 ltr.

Wein- / Sektkühler „LARGE“

wine / champagne bowl
cubitera para vino y cava
seau à vin ou champagne

gehämmerte Oberfläche, mit 2 seitlichen Eingriffen, für 1-2 Flasche

hammered surface, with 2 handles on the side, for 1-2 bottle

superficie martillada, con 2 asas, para 1-2 botellas

surface martelée, avec 2 poignées, pour 1-2 bouteilles



	cm	↑ cm	ltr.	Farbe / Colour	€
36108	25,5 x 19	20	3,9	copper-look	32,00
36109	25,5 x 19	20	3,9	gunmetal-look	32,00



NEW

36106 2,1 ltr.

36107 2,1 ltr.

Wein- / Sektkühler „SMALL“

wine / champagne bowl
cubitera para vino y cava
seau à vin ou champagne

gehämmerte Oberfläche, für 1 Flasche

hammered surface, for 1 bottle

superficie martillada, para 1 botella

surface martelée, pour 1 bouteille



	cm	↑ cm	ltr.	Farbe / Colour	€
36106	20,5 x 14	17	2,1	copper-look	24,00
36107	20,5 x 14	17	2,1	gunmetal-look	24,00



36100 11 ltr.

36095 11 ltr.

Getränkewanne „TIN“

beverage tub
barreño botellines

bassine à glace

Metall verzinkt, mit Kunststoffeinsatz

galvanised metal, with plastic insert

metal galvanizado, con inserto de plástico

métal galvanisé, avec insert en plastique



	cm	↑ cm	ltr.	Farbe / Colour	€
36100	40 x 28	22	11	copper-look	36,00
36101	40 x 28	22	11	black-metal-look	31,00
36095	40 x 28	22	11	metal-look	30,00
36096	50 x 23	23	18	metal-look	36,00



mit Kunststoffeinsatz
with plastic insert
con inserto de plástico
avec insert en plastique



71490

Kreidestift zum
Beschriften | chalk
marker for writing
S. 304

CONFERENCE



Flaschenkühler „CONFERENCE“

conference bottle cooler
enfriador múltiple
rafraîchisseur



inklusive Kühllakku, Flaschenöffner, Kronkorkenschale,
mit 6 Öffnungen Ø 6,7 cm für 0,25 - 0,5 Liter-Flaschen

incl. bottle cooler, bottle opener, small cap bowl,
with 6 holes Ø 6,7 cm for 0,25 to 0,5 liter bottles

con acumulador de frío, abridor, recuperador de chapas,
6 plazas Ø 6,7 cm, para botellas de 0,25 a 0,5 ltr.

avec accumulateur de froid, décapsuleur, bol récupérateur
de capsules, 6 places Ø 6,7 cm, pour bouteilles de 0,25 à 0,5 litres

	Ø cm	↑ cm	Farbe / Colour	€
00620	23	15	White	54,00
00621	23	15	Black	54,00



Kühllakku

cooler
acumulador de frío
accumulateur de froid



	Ø cm	→ cm	Farbe / Colour	€
00615	7,5	11,5	Black	10,50



Flaschenöffner

bottle opener
abridor
décapsuleur



	Ø cm	→ cm	€
00617	1	13,5	6,10



Kronkorkenschale

cap bowl
cuenco para chapas
bol récupérateur de capsules



	Ø cm	↑ cm	Farbe / Colour	€
00618	6,5	3	White	2,50
00619	6,5	3	Black	2,50

TEAPOTS



NEW



10995 0,8 ltr.



10996 0,8 ltr.

mit Teesieb / with tea strainer

Teekanne „ASIA“

teapot
tetera
théière

aus Gusseisen, innen emailliert, abnehmbarer Deckel, mit Teesieb aus Edelstahl

made of cast iron, enamelled inside, removable lid, with tea strainer made of stainless steel

hierro fundido, interior esmaltado, tapa extraíble, con colador de té de acero inoxidable

en fonte, émaillé à l'intérieur, couvercle amovible, avec une passoire à thé en acier inox

	cm	↑ cm	ltr.	Farbe / Colour	€
10995	17 x 14	17	0,8	■	26,00
10996	17 x 14	17	0,8	■	26,00



10991 0,8 ltr.



10992 0,8 ltr.

mit Teesieb / with tea strainer

Teekanne „ASIA“

teapot
tetera
théière

aus Gusseisen, innen emailliert, mit abnehmbarem Deckel,

inklusive Teesieb aus Edelstahl, ideal für 2-3 Tassen. Geeignet für alle Herdarten.

made of cast iron, enamelled inside, with removable lid, incl. tea strainer made of stainless steel, ideal for 2-3 cups. Suitable for all types of stoves.

hierro fundido, interior esmaltado, con tapa extraíble, incl. colador de té de acero inoxidable, ideal para 2-3 tazas. Apta para todas las placas de cocina.

en fonte, émaillé à l'intérieur, avec couvercle amovible, y compris une passoire à thé en acier inox, idéale pour 2-3 tasses. Convient à tous les types de feux (gaz, vitro ou induction).

	cm	↑ cm	ltr.	Farbe / Colour	€
10991	19,5 x 18	15	0,8	■	26,00
10992	19,5 x 18	15	0,8	■	26,00



0,3 ltr.

ohne Teesieb / without tea strainer

Teekanne „ASIA“

teapot
tetera
théière

aus Gusseisen, innen emailliert, mit abnehmbarem Deckel, ohne Teesieb aus Edelstahl

made of cast iron, enamelled inside, with removable lid, without tea strainer made of stainless steel

hierro fundido, interior esmaltado, con tapa extraíble, sin colador de té de acero inoxidable

en fonte, émaillé à l'intérieur, avec couvercle amovible, sans une passoire à thé en acier inox

	cm	↑ cm	ltr.	Farbe / Colour	€
10990	12,5 x 11	12,5	0,3	■	21,00

TEAPOTS



Stövchen „ASIA“

teapot warmer
calentador de tetera
chauffe-théière



1-flammiges Stövchen aus Gusseisen mit abnehmbarem Deckel (Lieferung ohne Teelicht).

1-flame cast iron warmer with removable lid (delivery without tealight).

calentador de tetera de hierro fundido con 1 quemador con tapa extraíble (se entrega sin vela).

chauffe-théière en fonte à 1 brûleur avec couvercle amovible (livraison sans bougie).

	Ø cm	↑ cm	Farbe / Colour	€
10994	13	7,5	■	16,40

Untersetzer aus Gusseisen mit Antirutschfüßchen / cast iron coaster with non-slip feet

	Ø cm	↑ cm	Farbe / Colour	€
10993	13,5	1,5	■	5,50



Teebox

tea-box
caja para té
boîte à thés et infusions



Box aus Rubberwood mit Sichtfenster, mit Aufschrift „Tee“, 4 Kammern können mit je 30 kuvertierten Teebeuteln bestückt werden

rubber wood box with clear transparent window, with inscription „Tee“, 4 chambers for approx. 30 tea bags each

caja de madera de goma clara con ventana transparente, con inscripción „Tee“, 4 compartimentos, y cada uno para aproximadamente 30 bolsitas de té

en bois d'hévéa clair avec fenêtré, avec inscription „Tee“, 4 compartiments, pour environ 30 sachets chacun

	cm	↑ cm	Farbe / Colour	€
11575	33,5 x 20	9	■	21,00
11574	33,5 x 20	9	■	21,00

	cm	↑ cm	Farbe / Colour	€
11576	33,5 x 20	9	■ ohne Aufschrift / without inscription sin inscripción / sans inscription	21,00



Teebox

tea-box
caja para té
boîte à thés et infusions



Box aus Rubberwood mit Sichtfenster, mit Aufschrift „Tee“, 12 Kammern können mit je 12 kuvertierten Teebeuteln bestückt werden

rubber wood box with clear transparent window, with inscription „Tee“, 12 chambers for approx. 12 tea bags each

caja de madera de goma clara con ventana transparente, con inscripción „Tee“, 12 compartimentos, y cada uno para aproximadamente 12 bolsitas de té

en bois d'hévéa clair avec fenêtré, avec inscription „Tee“, 12 compartiments, pour environ 12 sachets chacun

	cm	↑ cm	Farbe / Colour	€
11775	31 x 28	9	■	28,00
11776	31 x 28	9	■	28,00



Teebox / Multibox

tea caddy
caja para té
boîte à thés et infusions



3 Fächer für kuvertierte Teebeutel, 1 Fach für Zucker, Kekse, etc., Deckel aufklappbar

3 compartments for tea bags, 1 compartment for sugar, biscuits, etc., hinged lid

3 compartimentos para bolsitas de té, 1 compartimento para azúcar, galletas, etc. tapa abatible

3 compartiments pour sachets de thé, 1 compartiment pour sucre, biscuits, etc., couvercle abatible

	cm	↑ cm	€
11563	22 x 17	9	21,00

CEREAL DISPENSERS



Cerealienspender „FRESH & EASY“

cereal dispenser
dispensador de cereales
distributeur de céréales

Black
&
beautiful

SAN
KUNSTSTOFF

SILIKON
SILICON

GUSS
ZINK

EDELSTAHL
STAINLESS
INOX

Behälter herausnehmbar, „Feierabend-Deckel“ für das aromadichte Lagern,
portionieren durch einfaches Drehen

removable canister, special lid to keep the cereals fresh, easy to use, rotate the button
to get the muesli

contenedor extraíble, tapa especial para mantener los cereales frescos, fácil de usar,
se gira el pomo para servir los cereales

réipient amovible, couvercle spécial pour conserver les céréales,
usage facile en tournant le bouton

	cm	↑ cm	ltr.	Farbe / Colour	€
11840	22 x 17,5	52	4,5	■	86,00



Cerealienspender Duo „FRESH & EASY“

cereal dispenser
dispensador de cereales
distributeur de céréales

Black
&
beautiful

SAN
KUNSTSTOFF

SILIKON
SILICON

GUSS
ZINK

EDELSTAHL
STAINLESS
INOX

Behälter herausnehmbar, „Feierabend-Deckel“ für das aromadichte Lagern,
portionieren durch einfaches Drehen

removable canister, special lid to keep the cereals fresh, easy to use, rotate the button
to get the muesli

contenedor extraíble, tapa especial para mantener los cereales frescos, fácil de usar,
se gira el pomo para servir los cereales

réipient amovible, couvercle spécial pour conserver les céréales, usage facile en
tournant le bouton

	cm	↑ cm	ltr.	Farbe / Colour	€
11841	22 x 35	52	2 x 4,5	■	156,00

CEREAL DISPENSERS



Cerealienspender „FRESH & EASY“

cereal dispenser
dispensador de cereales
distributeur de céréales



Behälter herausnehmbar, „Feierabend-Deckel“ für das aromadichte Lagern, portionieren durch einfaches Drehen

removable canister, special lid to keep the cereals fresh, easy to use, rotate the button to get the muesli
contenedor extraíble, tapa especial para mantener los cereales frescos, fácil de usar, se gira el pomo para servir los cereales
récipient amovible, couvercle spécial pour conserver les céréales, usage facile en tournant le bouton

	cm	↑ cm	ltr.	€
11805	22 x 17,5	52	4,5	86,00



Cerealienspender Duo „FRESH & EASY“

cereal dispenser
dispensador de cereales
distributeur de céréales



Behälter herausnehmbar, „Feierabend-Deckel“ für das aromadichte Lagern, portionieren durch einfaches Drehen

removable canister, special lid to keep the cereals fresh, easy to use, rotate the button to get the muesli
contenedor extraíble, tapa especial para mantener los cereales frescos, fácil de usar, se gira el pomo para servir los cereales
récipient amovible, couvercle spécial pour conserver les céréales, usage facile en tournant le bouton

	cm	↑ cm	ltr.	€
11807	22 x 35	52	2 x 4,5	158,00



Cerealienspender „ROTATION“

cereal dispenser
dispensador de cereales
distributeur de céréales



matt poliert, drehbarer massiver Ständer, Behälter herausnehmbar, inklusive Frischhaltedeckel

matt polished, rotating food, canister removable, including airtight covers
pulido mate, giratorio, incluye tapas herméticas
poli mat, rotatif, inclut couvercles hermétiques

	Ø cm	↑ cm	ltr.	€
11970	38	54	3 x 4,5	320,00



Cerealienspender „ROTATION“

cereal dispenser
dispensador de cereales
distributeur de céréales



Buchenholz versiegelt, drehbarer massiver Ständer, Behälter herausnehmbar, inklusive Frischhaltedeckel

wood beech covered waterproof, rotating foot, canister removable, incl. airtight cover
tapa en madera de haya resistente al agua, pie giratorio, recipiente extraíble, incluye tapa hermética
couvercle en hêtre traitée contre l'humidité, pied rotatif, récipients démontables, inclut couvercles hermétiques

	Ø cm	↑ cm	ltr.	€
11975	38	54	3 x 4,5	324,00



Cerealienspender „BRIDGE“

cereal dispenser
dispensador de cereales
distributeur de céréales



Behälter herausnehmbar, „Feierabend-Deckel“ für das aromadichte Lagern, portionieren durch einfaches Drehen

removable canister, special lid to keep the cereals fresh,
easy to use, rotate the button to get the muesli
contenedor extraíble, tapa especial para mantener los cereales frescos,
fácil de usar, se gira el pomo para servir los cereales
récipient amovible, couvercle spécial pour conserver les céréales,
usage facile en tournant le bouton

	cm	↑ cm	ltr.	Farbe / Colour		€
13987	21 x 20	55,5	4,5		Ahorn	109,00



Cerealienspender „BRIDGE“

cereal dispenser
dispensador de cereales
distributeur de céréales



Behälter herausnehmbar, „Feierabend-Deckel“ für das aromadichte Lagern, portionieren durch einfaches Drehen

removable canister, special lid to keep the cereals fresh,
easy to use, rotate the button to get the muesli
contenedor extraíble, tapa especial para mantener los cereales frescos,
fácil de usar, se gira el pomo para servir los cereales
récipient amovible, couvercle spécial pour conserver les céréales,
usage facile en tournant le bouton

	cm	↑ cm	ltr.	Farbe / Colour		€
14987	21 x 20	55,5	4,5		Wenge	109,00



Buffetständer „GOOD MORNING“

buffet stand
expositor de buffet
présentoir de buffet



4-teiliges Set: 1 Holzständer inklusive 3 Gläser mit luftdichtem Klappdeckel

4 pcs.: 1 wood stand including 3 glasses with airtight cover
set de 4: 1 soporte con 3 cuencos de cristal con cierre hermético
set de 4: 1 présentoir avec 3 bols en verre avec fermeture hermétique

	cm	Farbe / Colour		€ / set
13965	43 x 17		Ahorn	98,00
14965	43 x 17		Wenge	98,00

Glas mit luftdichtem Klappdeckel

glass with airtight cover
cristal, cierre hermético
verre, fermeture hermétique

	cm	↑ cm	ltr.	€
82328	12 x 12	22	2	9,00

CEREAL DISPENSERS

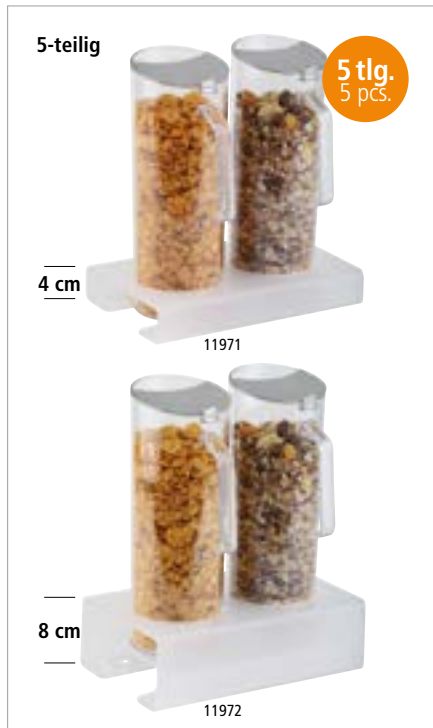

Cerealien-Bar

cereal-bar

barra para dispensador de cereales

bar à céréales



5-teiliges Set: mit Ständerhöhe 4 oder 8 cm: 1 Ständer aus Acryl gefrostet und rutschfest + 2 Karaffen mit schwenkbarem Edelstahl-Deckel + 2 luftdichte Frischhaltedeckel

5 pcs.: with stand heights 4 or 8 cm: 1 stand acryl frosted and non-slip + 2 pitchers with stainless steel flap lid + 2 airtight covers

set de 5: stands a diferentes alturas, 4 u 8 cm: 1 stand acryl + 2 jarras con tapa de solapa de acero inoxidable + 2 tapas herméticas adicionales

set de 5: supports à différentes hauteurs: 4 ou 8 cm - 1 support acrylique satiné antidérapant + 2 pichets à céréales avec couvercle à charnière inox + 2 couvercles hermétiques

	cm	↑ cm	ltr.	€
11971	26 x 17	28,5	2 x 1,5	76,00
11972	26 x 17	32,5	2 x 1,5	104,00



ideal für Stufenpräsentation
best for staged presentations



Cerealien-Bar

cereal-bar

barra para dispensador de cereales

bar à céréales



7-teiliges Set: mit Ständerhöhe 4 oder 8 cm: 1 Ständer aus Acryl gefrostet und rutschfest + 3 Karaffen mit schwenkbarem Edelstahl-Deckel + 3 luftdichte Frischhaltedeckel

7 pcs.: with stand heights 4 or 8 cm: 1 stand acryl frosted and non-slip + 3 pitchers with stainless steel flap lid + 3 airtight covers

set de 7: con stands a diferentes alturas, 4 u 8 cm: 1 stand acryl + 3 jarras con tapa de solapa de acero inoxidable + 3 tapas herméticas adicionales

set de 7: supports à différentes hauteurs: 4 ou 8 cm - 1 support acrylique satiné antidérapant + 3 pichets à céréales avec couvercle à charnière inox + 3 couvercles hermétiques

	cm	↑ cm	ltr.	€
11973	38 x 17	28,5	3 x 1,5	108,00
11974	38 x 17	32,5	3 x 1,5	114,00



ideal für Stufenpräsentation
best for staged presentations



Cerealienkaraffe

cereal pitcher

jarra de cereales

pichet à céréales



schwenkbarer Edelstahl-Deckel, inklusive luftdichtem Frischhaltedeckel

stainless steel flap lid, incl. 1 airtight cover

tapa giratoria de acero inoxidable con tapa hermética para mantener los alimentos frescos

couvercle pivotant en acier inox avec couvercle hermétique pour conserver les aliments

	Ø cm	↑ cm	ltr.	€
10778	10	28	1,5	27,00

Frischhaltedeckel / conservation lid / tapa de conservación / couvercle de conservation

	€
10668	3,00

CANISTERS



82255 1,0 ltr.



82256 2,0 ltr.



82257 2,5 ltr.

Vorratsglas „WOODY“

canister with lid
bote con tapa
pot en verre avec couvercle



Glasbehälter mit Holzdeckel, aromadichter Verschluss

glass container, aroma-tight screw cap

recipiente de cristal, tapa con cierre hermético para conservar el aroma

réipient en verre, couvercle avec fermeture hermétique pour conserver l'arôme

	cm	↑ cm	ltr.	€
82255	14 x 14	11,0	1,0	11,50
82256	14 x 14	17,0	2,0	12,60
82257	14 x 14	21,5	2,5	14,40



Holzdeckel aus Kiefernholz mit Silikondichtung
wooden lid from pine wood with silicone gasket



82265 1 ltr.



82266 1,2 ltr.



82267 1,5 ltr.

Vorratsglas

canister with lid
bote con tapa
pot en verre avec couvercle

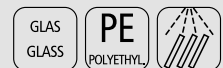

inklusive Glasdeckel mit Dichtung und Beschriftungsfeld, somit bleibt Ihre Ware frisch

including glass lid with seal and labeling field, thus, your goods remain fresh

con tapa de vidrio con junta y campo de etiquetado, por lo tanto, sus productos permanecen frescos

y compris couvercle en verre avec joint et le domaine de l'étiquetage, ainsi, vos marchandises restent fraîches

	Ø cm	↑ cm	ltr.	€
82265	11,0	18,0	1,0	7,60
82266	11,5	19,5	1,2	8,50
82267	12,0	21,0	1,5	11,20



71490

Kreidestift zum
Beschriften | chalk
marker for writing
S. 304

CANISTERS



Vorratsglas „CLASSIC“

canister with lid
bote con tapa
pot en verre avec couvercle



inklusive Glasdeckel mit Dichtung, somit bleibt Ihre Ware frisch

including glass lid with seal, thus, your goods remain fresh

con tapa de vidrio con junta, por lo tanto, sus productos permanecen frescos

y compris couvercle en verre avec joint, ainsi, vos marchandises restent fraîches

	Ø cm	↑ cm	ltr.	€
82250	11,5	16,0	0,9	7,80
82251	14,0	21,5	2,0	13,20
82252	18,0	26,0	4,0	21,60
82253	20,0	30,0	6,0	25,40



Vorratsglas mit luftdichtem Klappdeckel

glass with airtight cover
bote con cierre hermético
pot en verre avec fermeture hermétique



	cm	↑ cm	ltr.	€
82328	12 x 12	22	2	9,00



Vorratsglas

canister with lid
bote con tapa
pot en verre avec couvercle



mit Löffel, Schraubdeckel mit aromadichtem Verschluss, Edelstahlöffel mit magnetischem Silikongriff

tight cover, stainless steel spoon with magnetic silicone handle

tapa a rosca con cierre hermético, cuchara de acero inoxidable con mango de silicona magnético

couvercle à vis avec fermeture hermétique, cuillère en acier inox avec manche de silicone aimanté

	cm	↑ cm	ltr.	€
00636	17 x 12,5	18	1 - 2,2	15,00

seitlich gestellt
placed sideways
1 ltr.



hochkant gestellt
placed upright
2,2 ltr.

Vorratsglas

canister with lid
bote con tapa
pot en verre avec couvercle
mit Schraubdeckel, aromadichtem Verschluss
aroma-tight screw cap
tapa a rosca para conservar el aroma
couvercle à vis pour conserver l'arôme



	cm	↑ cm	ltr.	€
00637	17 x 12,5	18	1 - 2,2	10,00

stapelbar
stackable

↑ **Frontklappe**
front lid



11884

11885

Universalbox

box / sweetbox
caja dispensadora
boîte distributrice
ideal als Verkaufsbox, mit Frontdeckel
best to present sweets etc., all-purpose, with front lid
la perfecta solución para presentar golosinas, universal, con tapa frontal
la solution idéale pour les friandises et autres, universel, avec couvercle frontal



	cm	↑ cm	Farbe / Colour	€
11884	23 x 14,5	15	White	14,00
11885	23 x 14,5	15	Red	14,00

 Sturzform



82239
370 ml

82240
580 ml

Weck-Gläser mit Deckel, 2er Set

Weck-glasses with lid, 2 pcs.
Weck tarros de vidrio con tapa, set de 2
Weck verrines avec couvercle, set de 2



2 Gläser + 2 Edelstahl Deckel
2 glasses + 2 stainless steel lids
2 tarros + 2 tapas de acero inoxidable
2 verrines + 2 couvercles en acier inox

	Ø cm	↑ cm	ltr.	pcs	€ / set
82239	11	7,5	0,37	2	19,00
82240	11	11	0,58	2	21,60

 Sturzform



82243
370 ml

82244
580 ml

Weck-Gläser mit Deckel, 2er Set

Weck-glasses with lid, 2 pcs.
Weck tarros de vidrio con tapa, set de 2
Weck verrines avec couvercle, set de 2



2 Gläser + 2 Deckel aus Buchenholz
2 glasses + 2 beech wood lids
2 tarros + 2 tapas de madera de haya
2 verrines + 2 couvercles en bois hêtre

	Ø cm	↑ cm	ltr.	pcs	€ / set
82243	11	7,5	0,37	2	14,60
82244	11	11	0,58	2	17,00

NEW PERFECTO



NEW

3 tlg.
3 pcs.



33300

3-teiliges Set | 3 pcs.



33302

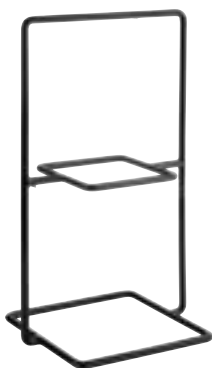

33304



2-stufige Etagère „PERFECTO SMALL“

2-tier tray
bandeja dos alturas
étagère carré 2 hauteurs



3-teiliges Set, bestehend aus:

- 1 Buffetständer, Metall, PVC, schwarz, 23 x 19 cm, H: 40,5 cm
- 2 Bretter aus Eichenholz, geölt, 20 x 20 cm, H: 2 cm

3 pcs., consisting of:

- 1 buffet stand, metal, PVC, black, 23 x 19 cm, h: 40,5 cm
- 2 boards, oiled oak, 20 x 20 cm, h: 2 cm

set de 3, compuesto por:

- 1 soporte de buffet, metal, PVC, negro, 23 x 19 cm, a: 40,5 cm
- 2 tablas de roble aceitado, 20 x 20 cm, a: 2 cm

set de 3, composé de :

- 1 support de buffet, métal, PVC, noir, 23 x 19 cm, H: 40,5 cm
- 2 planches en bois de chêne, huilées, 20 x 20 cm, h: 2 cm

	cm	↑ cm	€ / set
33300	20 x 23	40,5	44,00

Brett aus Eichenholz / oak board / tabla de roble / planche en chêne

	cm	↑ cm	€
33302	20 x 20	2	12,00

Buffetständer / buffet stand / soporte de buffet / support de buffet

	cm	↑ cm	€
33304	19 x 23	40,5	22,00



Präsentationsmöglichkeit
presentation example



2-stufige Etagère „PERFECTO LARGE“

2-tier tray
bandeja dos alturas
étagère carré 2 hauteurs



4-teiliges Set, bestehend aus:

- 2 Buffetständer, Metall, PVC, schwarz, 23 x 19 cm, H: 40,5 cm
- 2 Bretter aus Eichenholz, geölt, 80 x 20 cm, H: 2 cm

4 pcs., consisting of:

- 2 buffet stands, metal, PVC, black, 23 x 19 cm, h: 40,5 cm
- 2 boards, oiled oak, 80 x 20 cm, h: 2 cm

set de 4, compuesto por:

- 2 soportes de buffet, metal, PVC, negro, 23 x 19 cm, a: 40,5 cm
- 2 tablas de roble aceitado, 80 x 20 cm, a: 2 cm

set de 4, composé de :

- 2 supports de buffet, métal, PVC, noir, 23 x 19 cm, h: 40,5 cm
- 2 planches en bois de chêne, huilées, 80 x 20 cm, h: 2 cm

	cm	↑ cm	€ / set
33301	80 x 23	40,5	139,00

Brett aus Eichenholz / oak board / tabla de roble / planche en chêne

	Ø cm	↑ cm	€
33303	80 x 20	2	50,00

Buffetständer / buffet stand / soporte de buffet / support de buffet

	cm	↑ cm	€
33304	19 x 23	40,5	22,00



Präsentationsmöglichkeit
presentation example



Präsentationsmöglichkeit 3 Buffetständer + 4 Bretter
presentation example 3 buffet stands / 4 boards



platzsparend
space saving

BUFFET STAND

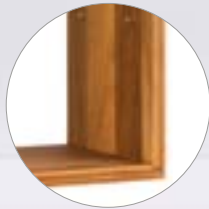

Eichenholz geölt
oak wood oiled

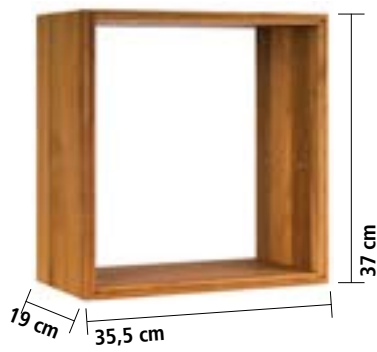

83481
GN 1/3



83491
GN 1/3

Buffetständer „WINDOW“

buffet stand
soporte para buffet
présentoir buffet

Eichenholz geölt
oak wood oiled
madera de roble aceitada
bois de chêne huilé



	cm	↑ cm		€
11740	35,5 x 19	37	inkl. 20 Haltestiften für Einlegeböden / incl. 20 fixing pins for shelves	84,00



inklusive 20 Haltestifte
including 20 fixing pins



Präsentationsmöglichkeiten
presentation examples

geeignet für GN 1/3 Tablett / for GN 1/3 trays / para bandejas GN 1/3 / pour plateaux GN 1/3

	cm	↑ cm	Farbe / Colour	€
84187	32,5 x 17,6	1,5		15,60
83481	32,5 x 17,6	3,0		17,00
83491	32,5 x 17,6	3,0		17,00



NEW

ACACIA

NEW



00794 1,8 ltr.



00795 2,5 ltr.



00796 3,0 ltr.

Schale „ACACIA“

bowl
cuenco
bol

aus geöltem Akazienholz
made of oiled acacia wood
de madera de acacia aceitada
en bois d'acacia huilé



	Ø cm	↑ cm	ltr.	€
00794	21	8,5	1,8	35,00
00795	25	8,5	2,5	40,00
00796	27	8,5	3,0	45,00



passender Deckel mit Löffelaussparung / suitable cover with notched for spoons /
tapa adecuada con espacio para la cuchara / couvercle appropriée avec encoche pour la louche

	Ø cm	↑ cm	fits to	€
83920	20,5	1,3	00794	9,20



3 Größen ineinander
3 sizes in each other



33269

Buffetständer „MULTI ROUND“

buffet stand
soporte para buffet
présentoir buffet

Metall, mit schwarzer Antirutschbeschichtung
metal, with black anti-slide coating
metal, con revestimiento antideslizante negro
métal, avec revêtement antidérapant noir



	Ø cm	↑ cm	€
33269	15,5 / 18	8	10,90
33270	15,5 / 18	10	13,00
33271	15,5 / 18	18	16,70

BUFFET DISPLAY



Buffet Box „TOAST BOX“

buffet box
caja de buffet
boîte de buffet



aus geöltem Eichenholz, Deckel aus Kunstleder, 2 Fächer: 28 x 16,5 cm, H: 16 cm, mit herausnehmbarem Sichtfenster aus Acryl

made of oiled oak wood, lid made of imitation leather, 2 compartments: 28 x 16.5 cm, H: 16 cm, with removable viewing window made from acrylic

de madera de roble aceitada, tapa de polipiel, 2 compartimentos: 28 x 16,5 cm, H: 16 cm, con mirilla extraíble de acrílico

en bois de chêne huilé, couvercle en simili-cuir, 2 compartiments : 28 x 16,5 cm, H : 16 cm, avec fenêtre d'observation amovible en acrylique

	cm	↑ cm	Farbe / Colour	€
11713	36 x 33,5	16	natural oak	99,00
11714	36 x 33,5	16	dark oak	99,00



Präsentationsmöglichkeit
presentation example



Buffet Box „SEWING BASKET“

buffet box
caja de buffet
boîte de buffet



aus geöltem Eichenholz, 3 Fächer: 33 x 27 cm, H: 7 cm, passend für GN 1/2

made of oiled oak wood, 3 compartments: 33 x 27 cm cm, H: 7 cm, suitable for GN 1/2

de madera de roble aceitada, 3 compartimentos: 33 x 27 cm, H: 7 cm, apto para GN 1/2

en bois de chêne huilé, 3 compartiments: 33 x 27 cm, H: 7 cm, convient pour GN 1/2

	cm	↑ cm	Farbe / Colour	€
11711	36 x 29	28	natural oak	279,00
11712	36 x 29	28	dark oak	279,00

geschlossen | closed
37 x 29 cm, H: 28 cm

geöffnet | open
70,5 x 37 cm, H: 53,5 cm



Präsentationsmöglichkeit
presentation example



Buffetgestell „TRIANGLE“

buffet stand
expositor de buffet
présentoir buffet



Ahorn massiv, 3 Ebenen: 1.: 53 x 19 cm, 2.: 40 x 17,5 cm, 3.: 30 x 15 cm
solid maple, 3 levels: 1.: 53 x 19 cm, 2.: 40 x 17,5 cm, 3.: 30 x 15 cm
arce sólido, 3 niveles: 1.: 53 x 19 cm, 2.: 40 x 17,5 cm, 3.: 30 x 15 cm
érable massif, 3 niveaux: 1.: 53 x 19 cm, 2.: 40 x 17,5 cm, 3.: 30 x 15 cm

	cm	↑ cm	Farbe / Colour	€
13966	53 x 21	50	Ahorn / maple	145,00

Buche massiv, 3 Ebenen: 1.: 53 x 19 cm, 2.: 40 x 17,5 cm, 3.: 30 x 15 cm

beech maple, 3 levels: 1.: 53 x 19 cm, 2.: 40 x 17,5 cm, 3.: 30 x 15 cm
haya sólido, 3 niveles: 1.: 53 x 19 cm, 2.: 40 x 17,5 cm, 3.: 30 x 15 cm
hêtre massif, 3 niveaux: 1.: 53 x 19 cm, 2.: 40 x 17,5 cm, 3.: 30 x 15 cm

	cm	↑ cm	Farbe / Colour	€
14966	53 x 21	50	Wenge / wenge	145,00



Buffetgestell „BIRDCAGE“

buffet stand
soporte para buffet
présentoir buffet



Gestell aus schwarzem Metall, inklusive 2 Akazienholzplatten
black metal frame, incl. 2 acacia wood panels
soporte metálico negro, con 2 tablas de madera de acacia
support métallique noir, avec 2 panneaux en bois d'acacia

	Ø cm	↑ cm	€
33206	26	54	55,00

Ersatz-Holzplatte

spare wooden panel
tabla de madera de recambio
panneau en bois de rechange

	Ø cm	↑ cm	€
33207	25	1	15,40



passende Akazienholzplatte
fitting acacia wood panels



Gestell mit abgerundeten Füßen
frame with rounded feet



NEW FRIENDLY BOWL

- hergestellt aus gebrauchtem Plastik – aus 100% recyceltem Post-Consumer PET (RePET)
- vollständig recycelbar und 100% umweltschonend
- spülmaschinengeeignet bis 55°C
- made from used plastic – made of 100% recycled post-consumer PET (RePET)
- fully recyclable and 100% environmentally friendly
- dishwasher safe up to 55°C
- fabricado de plástico usada: 100% de PET reciclado postconsumo (RePET)
- totalmente reciclable y 100% respetuoso con el medio ambiente
- apto para lavavajillas hasta 55°C
- fabriqué de plastique usagée – composé à 100% de PET recyclé post-consumation (RePET)
- entièrement recyclable et 100% écologique
- lavable au lave-vaisselle jusqu'à 55°C

Safe the Planet:
Gebrauchtes Plastik
+ Zerkleinern + Reinigen
+ Schmelzen und Spritzen
= NEUES LEBEN

Safe the Planet:
used plastic
+ crushing + cleaning
+ melting and spraying
= NEW LIFE

Safe the Planet:
plástico usada
+ trituración + limpieza
+ fusión y pulverización
= NUEVA VIDA

Safe the Planet :
plastique usagée
+ broyage + nettoyage
+ fonte et injection
= NOUVELLE VIE



Schale „FRIENDLY BOWL“ bowl cuenco bol



friendly bowl

vollständig recycelbar und 100% umweltschonend
fully recyclable and 100% environmentally friendly
totalmente reciclable y 100% respetuoso con el medio ambiente
entièrement recyclable et 100% écologique

	cm	↑ cm	ltr.	Farbe / Colour	€
79000	9,0 x 9,0	4,0	0,14	■	4,20
79001	9,0 x 9,0	4,0	0,14	■	4,20
79002	12,5 x 12,5	6,5	0,40	■	6,00
79003	12,5 x 12,5	6,5	0,40	■	6,00
79004	19,0 x 19,0	9,0	1,50	■	15,00
79005	19,0 x 19,0	9,0	1,50	■	15,00



Tablett „FRIENDLY TRAY“ tray bandeja plateau



friendly tray

vollständig recycelbar und 100% umweltschonend
fully recyclable and 100% environmentally friendly
totalmente reciclable y 100% respetuoso con el medio ambiente
entièrement recyclable et 100% écologique

	cm	↑ cm	GN	Farbe / Colour	€
79006	32,5 x 26,5	3	1/2	■	15,80
79007	32,5 x 26,5	3	1/2	■	15,80



Dressingtopf-Display / -Station
 wooden station for 3 dressing pots
 expositor de madera para 3 salseras
 présentoir en bois pour 3 pots à sauce
inklusive 3 Beschriftungsschilder aus Metall
 including 3 metal labels
 con 3 etiquetas de metal
 avec 3 étiquettes métalliques



	cm	↑ cm	€
84863	40 x 16	9	32,00



passend für 83311, 83867, 30060
 suitable for 83311, 83867, 30060



Dressingtopf „PASTELL“
 dressing pot
 salsera
 pot à sauce



	cm	↑ cm	ltr.	Farbe / Colour	€
84862	13	19,5	1,5		22,00
84860	13	19,5	1,5		22,00
84861	13	19,5	1,5		22,00

Beschriftungsetiketten, 72 Stück / labeling labels, 72 pcs. / etiquetas, 72 pzs / étiquettes, 72 pcs.

	cm	Farbe / Colour	€
00069	8 x 4,6		10,00



mit Antirutschfüßchen
 with non-slip feet



stapelbar
 stackable



Dressingtopf „CASUAL“
 dressing pot
 salsera
 pot à sauce



	cm	↑ cm	ltr.	Farbe / Colour	€
83867	12	21,5	1		29,80
83868	12	21,5	1		29,80



Dressingtopf
 dressing pot
 salsera
 pot à sauce



Deckel mit Löffelaussparung
 cover notched for spoon
 tapa agujereada para el cucharón
 couvercle avec espace pour la louche

	Ø cm	↑ cm	ltr.	€
83310	17,0	15	2,0	27,00
83311	13,0	13	0,8	14,80

BUFFET DISPLAY



Schale „ELEMENT“

bowl
cuenco
bol



	Ø cm	↑ cm	ltr.	€
30000	22	6,0 / 10,5	1,1	23,00
30001	26	7,5 / 13,0	1,7	29,00
30002	29,5	8,5 / 14,5	2,5	34,00



möbelschonende Unterseite
furniture-friendly underside



Präsentationsmöglichkeiten
presentation example



Schale „COCONUT“

bowl
cuenco
bol



	Ø cm	↑ cm	ltr.	€
30020	18	9,5	1	24,00
30021	23	12,5	2,2	32,00



möbelschonende Unterseite
furniture-friendly underside



Buffetständer

buffet stand
expositor de buffet
présentoir buffet

Akazienholz
acacia wood
madera de acacia
bois d'acacia



	Ø cm	↑ cm	€
33255	15	10	17,00
33256	25	15	21,00

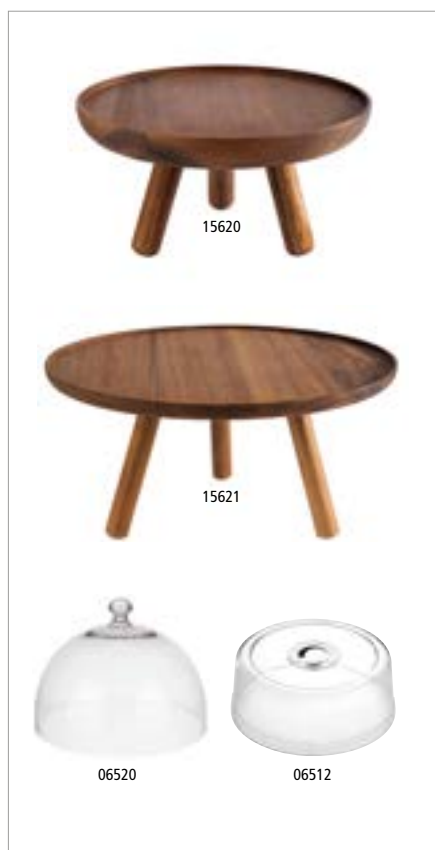

Buffetständer „ACACIA“

buffet stand
soporte para buffet
présentoir buffet

Akazienholz geölt / acacia wood oiled / madera de acacia aceitada / bois d'acacia huilé



	Ø cm	↑ cm		€
15620	20,0	10,5		29,00
15621	30,5	15,0		51,00
15622	30,5	20,0		55,00

Frischhaltehaube / cover / campana / cloche



	Ø cm	↑ cm	fits to	€
06520	30	22	15621, 15622	40,00

Frischhaltehaube / cover / campana / cloche



	Ø cm	↑ cm	fits to	€
06512	30	11,5	15621, 15622	8,20



Buffetständer „ACACIA“

buffet stand
soporte para buffet
présentoir buffet

Akazienholz geölt / acacia wood oiled / madera de acacia aceitada / bois d'acacia huilé



	cm	↑ cm	GN	€
15623	53 x 16,2	20	2/4	60,00

GN Abdeckhaube / GN cover / GN campana/ GN cloche



	cm	↑ cm	GN	€
11044	53 x 16,2	10,5	2/4	23,00

BUFFET DISPLAY

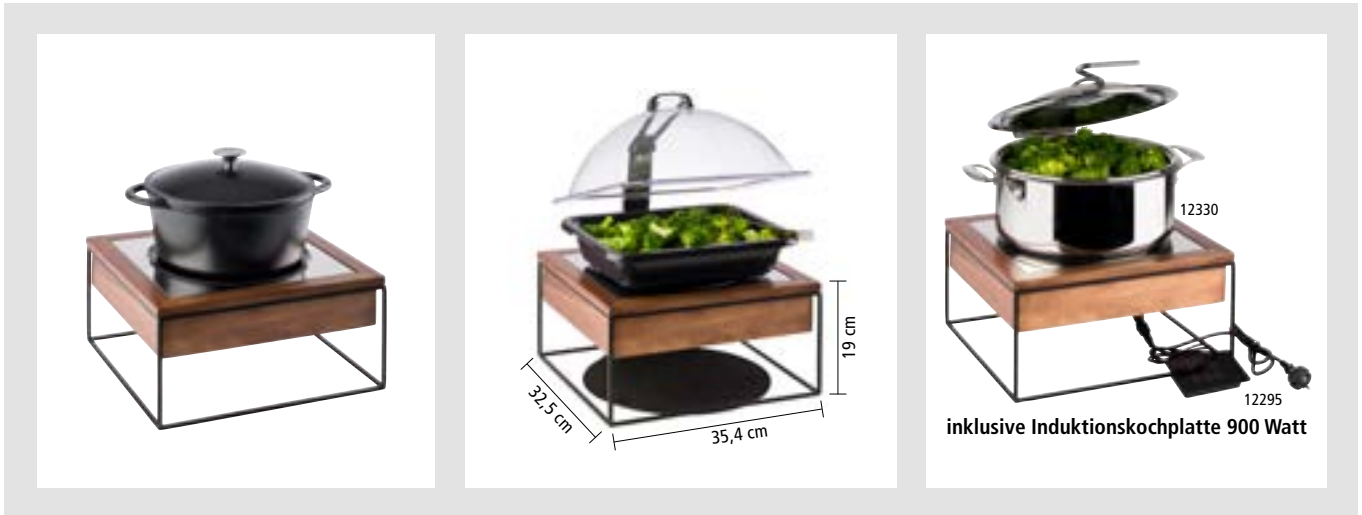

Die Induktionsstation mit Regler präsentiert sich in einem Set aus Walnussholz, einem schwarzen Metallständer und einer Induktionsheizung.

The induction station with controller is presented in a set of walnut wood, a black metal stand and an induction heater.

La estación de inducción con regulador se presenta en un set formado por una caja de madera de nogal, un soporte de metal negro y un calentador de inducción.

La station à induction avec température réglable se compose d'un caisson en bois noyer, d'un support métallique noir et d'une plaque à induction.



Induktionsstation, 4-teiliges Set

induction station, 4 pcs.
estación de inducción, set de 4
station d'induction, set de 4

4 teiliges Set:

- 1 Induktionskochplatte mit Regler (Ø 24 cm, 900 Watt)
- 1 Metallständer schwarz
- 1 Rahmen aus Walnussholz geölt
- 1 Edelstahlrahmen

4 pcs. set:

- 1 induction hotplate with controller (Ø 24 cm, 900 Watt)
- 1 metal stand black
- 1 frame in oiled walnut wood
- 1 stainless steel frame

set de 4:

- 1 placa de inducción con regulador (Ø 24 cm, 900 vatios)
- 1 soporte de metal negro
- 1 caja de madera de nogal aceitada
- 1 marco de acero inoxidable

set de 4:

- 1 plaque d'induction avec température réglable (Ø 24 cm, 900 watts)
- 1 support métallique noir
- 1 caisson en bois noyer huilé
- 1 cadre en acier inox



	cm	↑ cm	€
12270	35,4 x 32,5	19	210,00

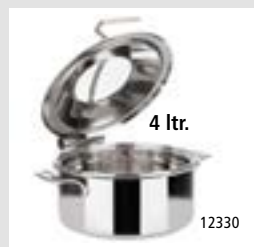

passendes Chafing Dish Set 12330
suitable chafing dish set 12330

Ersatzteile / replacement parts / piezas de repuesto / pièces de rechange

	cm	↑ cm		€
12271	35,4 x 32,5	8,5	Holzrahmen / wooden frame	54,00
12272	29,5 x 26,5	1	Edelstahlrahmen / stainless steel frame	22,00
12295	Ø 24	-	900 Watt Induktionskochplatte / induction plate	139,00
15506	35,4 x 32,5	17,6	Buffetständer schwarz / buffet stand black	22,80



Buffetleiter „BIG“

buffet ladder
dispensador en escalera
présentoir buffet en escalier



12-teiliges Set: 4 Glasschalen Ø 23 cm 2,5 Liter, 4 klappbare Schutzdeckel mit Beschriftungsfenster, 1 Leiter, 1 Doppelring, 2 Einzelringe, einfach und individuell zusammensetzbar

12 pcs. set: 4 glass bowls Ø 23 cm 2.5 litres, 4 hinged covers with card for inscription, 1 ladder, 1 double ring, 2 single rings, easy to fix and individual to use
set de 12: 4 cuencos de vidrio Ø 23 cm 2,5 l, 4 tapas abatibles con ventana para etiqueta, 1 soporte escalera, 1 aro doble, 2 aros sencillos, fácil de montar, posible usar individualmente
set de 12: 4 bols en verre Ø 23 cm 2,5 l, 4 couvercles à charnière et fenêtre pour étiquette, 1 support escalier, 1 cercle double, 2 cercles simples, montage facile, utilisable individuellement

	cm	↑ cm	€
11598	39 x 31	66	210,00



Buffetleiter „BIG“

buffet ladder
dispensador en escalera
présentoir buffet en escalier



11-teiliges Set: 6 Glasschalen Ø 23 cm 2,5 Liter, 1 Leiter, 2 Doppelringe, 2 Einzelringe, einfach und individuell zusammensetzbar

11 pcs. set: 6 glass bowls Ø 23 cm 2.5 litres, 1 ladder, 2 double rings, 2 single rings, easy and individual to use
set de 11: 6 cuencos de vidrio Ø 23 cm 2,5 l, 1 soporte escalera, 2 aros dobles, 2 aros sencillos, fácil montar, se puede usar individualmente
set de 11: 6 bols en verre Ø 23 cm 2,5 l, 1 support escalier, 2 cercles doubles, 2 cercles simples, montage facile, utilisable individuellement

	cm	↑ cm	€
11599	39 x 31	66	190,00

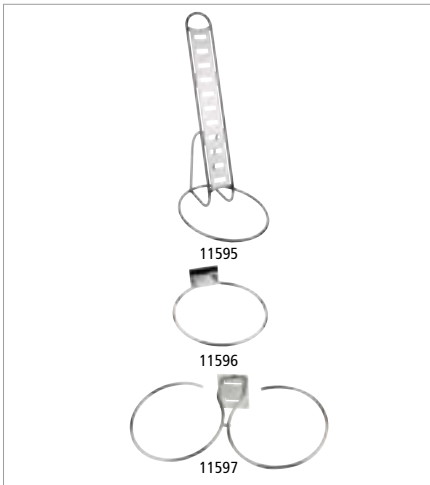

Einzelteile / spare parts / piezas de recambio / pièces détachées

Leitergestell / frame / marco solo / échelle support

	cm	↑ cm	€
11595	39 x 31	66	110,00

Einzelring / single ring / aro sencillo / cercle simple

	Ø cm	€
11596	23,5	15,00

Doppelring / double ring / aro doble / cercle double

	cm	€
11597	48 x 23,5	28,00



Schale

bowl
cuenco
bol



	Ø cm	↑ cm	ltr.	€
11875	23	10,5	2,5	6,40



Schutzdeckel mit Löffelaussparung

cover
tapa
couvercle



	Ø cm	€
11878	23,5	12,60

BUFFET DISPLAY



Buffetleiter „LITTLE“

buffet ladder
dispensador en escalera
présentoir buffet en escalier



12-teiliges Set: 4 Glasschalen Ø 14 cm 0,5 Liter, 4 klappbare Schutzdeckel mit Beschriftungsfenster, 1 Leiter, 1 Doppelring, 2 Einzelringe, einfach und individuell zusammensetzbar

12 pcs. set: 4 glass bowls Ø 14 cm 0.5 litres, 4 hinged covers with card for inscription, 1 ladder, 1 double ring, 2 single rings, easy and individual to use
set de 12: 4 cuencos de vidrio Ø 14 cm 0,5 l, 4 tapas abatibles con ventana para etiqueta, 1 soporte escalera, 1 aro doble, 2 aros sencillos, fácil montaje, se puede usar individualmente
set de 12: 4 bols en verre Ø 14 cm 0,5 l, 4 couvercles à charnière et fenêtre pour étiquette, 1 support escalier, 1 cercle double, 2 cercles simples, montage facile, utilisable individuellement

	cm	↑ cm	€
11498	30 x 30	48	130,00



Buffetleiter „LITTLE“

buffet ladder
dispensador en escalera
présentoir buffet en escalier



11-teiliges Set: 6 Glasschalen Ø 14 cm 0,5 Liter, 1 Leiter, 2 Doppelringe, 2 Einzelringe, einfach und individuell zusammensetzbar

11 pcs. set: 6 glass bowls Ø 14 cm 0.5 litres, 1 ladder, 2 double rings, 2 single rings, easy and individual to use
set de 11: 6 cuencos de vidrio Ø 14 cm 0,5 l, 1 soporte escalera, 2 aros dobles, 2 aros sencillos, fácil montaje, se puede usar individualmente
set de 11: 6 bols en verre Ø 14 cm 0,5 l, 1 support escalier, 1 cercles doubles, 2 cercles simples, montage facile, utilisable individuellement

	cm	↑ cm	€
11499	30 x 30	48	110,00

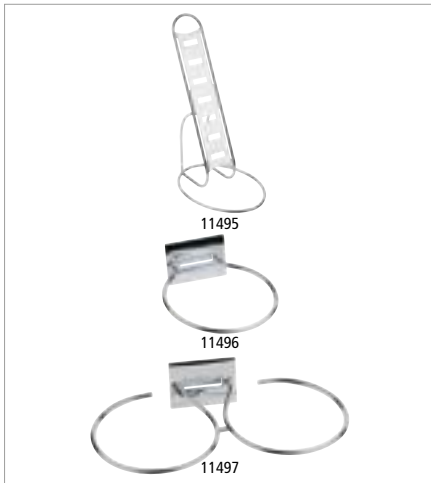

Einzelteile / spare parts / piezas de recambio / pièces détachées

Leitergestell / frame / marco solo / échelle support

	Ø cm	↑ cm	€
11495	30	48	40,00

Einzelring / single ring / aro sencillo / cercle simple

	Ø cm	€
11496	14	10,80

Doppelring / double ring / aro sencillo / cercle double

	cm	cm	€
11497	29,5 x 14,5	48	19,00



Schale

bowl
cuenco
bol



	Ø cm	↑ cm	ltr.	VE / unit	€ / pc.
11865	14	6,5	0,5	6	3,00



Schutzdeckel mit Löffelaussparung

cover
tapa
couvercle



	Ø cm	€
11868	14,5	12,00



7 tlg.
7 pcs.

Buffetgestell „SUNDAY“

buffet stand
expositor buffet
présentoir buffet



7-teiliges Set: 3 Glasschalen Ø 23 cm (2,5 Liter), 3 klappbare Schutzdeckel, 1 Gestell

7 pcs. set: 3 glass bowls Ø 23 cm (2,5 litres), 3 hinged covers, 1 stand

set de 7: 3 cuencos de cristal Ø 23 cm (2,5 l), 3 tapas con bisagra, 1 soporte

set de 7: 3 bols en verre Ø 23 cm (2,5 l), 3 couvercles à charnière, 1 support

	cm	↑ cm	€
11795	61 x 24	35	136,00

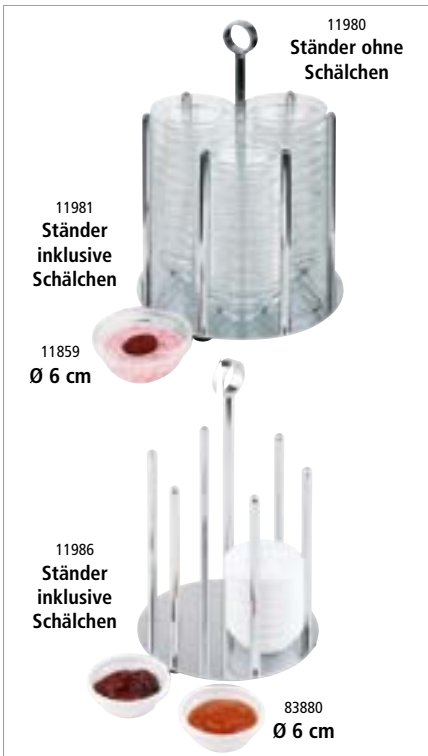

11980
Ständer ohne
Schälchen

11981
Ständer
inklusive
Schälchen

11859
Ø 6 cm

11986
Ständer
inklusive
Schälchen

83880
Ø 6 cm

Schälchenspender „MINI“

bowl holder
rack dispensador para cuencos
porte-bols



geeignet für Schalen Ø 6 cm, bestückbar mit bis zu 36 Schalen

for bowls Ø 6 cm, suitable for 36 bowls

para cuencos de Ø 6 cm, apto para 36 cuencos

pour bols de Ø 6 cm, pour 36 bols

	Ø cm	↑ cm	€
11981	14	25,5	Ständer inklusive 36 Glasschalen, Ø 6 cm frame with 36 bowls, Ø 6 cm 96,00
11986	14	25,5	Ständer inklusive 36 Melaminschalen, Ø 6 cm frame with 36 melamine bowls, Ø 6 cm 89,00

Schälchenspender „MINI“ / bowl holder / rack dispensador para cuencos / porte-bols

	Ø cm	↑ cm	€
11980	14	25,5	Ständer ohne Schalen / frame without bowls soporte sin cuencos / support sans bols 49,00



Serviergestell „WECK“

servicing stand
expositor
présentoir



ohne Gläser
without glasses
sin tarros
sans verrines

	Ø cm	↑ cm	€
33246	22	59	12 x Ø 6 cm 94,00

passende Gläser / matching glasses / tarros adecuados / verrines appropriées

	Ø cm	↑ cm	ltr.	pcs	€ / set
82310	6	5,5	0,08	12	25,30
82312	6	7,0	0,14	12	27,60
82314	6	8,0	0,16	12	27,60

BUFFET LADDER GN



Buffetleiter „LITTLE GN 1/3“

buffet ladder
dispensador en escalera
présentoir buffet en escalier

4-teilig: 1 Leiter-Gestell, 3 GN 1/3 Rahmen

4 pcs.: 1 ladder, 3 single rings GN 1/3

set de 4: 1 soporte escalera, 3 aros sencillos GN 1/3

set de 4: 1 support escalier, 3 cercles simples GN 1/3



	cm	↑ cm	fits to	€
11526	31,5 x 32	48	baskets / pans GN 1/3	78,00



Buffetleiter „LITTLE GN 1/2“

buffet ladder
dispensador en escalera
présentoir buffet en escalier

4-teilig: 1 Leiter-Gestell, 3 GN 1/3 Rahmen

4 pcs.: 1 ladder, 3 single rings GN 1/3

set de 4: 1 soporte escalera, 3 aros sencillos GN 1/3

set de 4: 1 support escalier, 3 cercles simples GN 1/3



	cm	↑ cm	fits to	€
11527	31,5 x 41,5	48	baskets / pans GN 1/2	98,00

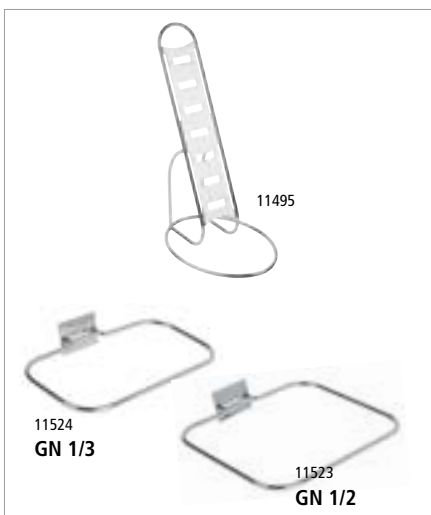

Einzelteile / spare parts / piezas sueltas / pièces détachées

Leitergestell / frame / marco de escalera / échelle support

11495	40,00
-------	-------

Einzelring GN 1/3 / single ring GN 1/3 / aro sencillo GN 1/3 / cercle simple GN 1/3

11524	14,80
-------	-------

Einzelring GN 1/2 / single ring GN 1/2 / aro sencillo GN 1/2 / cercle simple GN 1/2

11523	20,00
-------	-------



2x 84304
GN 1/4

1x 83757
GN 1/2

1x 83757
GN 1/2

1x 83757
GN 1/2

4 tlg.
4 pcs.

Buffetleiter „BIG GN 1/2“
buffet ladder
dispensador en escalera
présentoir buffet en escalier

5-teilig: 1 Leiter-Gestell, 4 GN 1/2 Rahmen
5 pcs.: 1 ladder, 4 single rings GN 1/2
set de 5: 1 soporte escalera, 4 aros sencillos GN 1/2
set de 5: 1 support escalier, 4 cercles simples GN 1/2

METALL VERCHROMT

	cm	↑ cm	fits to	€
11528	31,5 x 56	66	baskets / pans GN 1/2	160,00

3x 83753
GN 1/3

2x 83757
GN 1/2

1x 83759
GN 1/1

4 tlg.
4 pcs.

Buffetleiter „BIG GN 1/1“
buffet ladder
dispensador en escalera
présentoir buffet en escalier

4-teilig: 1 Leiter-Gestell, 3 GN 1/1 Rahmen
4 pcs.: 1 ladder, 3 single rings GN 1/1
set de 4: 1 soporte escalera, 3 aros sencillos GN 1/1
set de 4: 1 support escalier, 3 cercles simples GN 1/1

METALL VERCHROMT

	cm	↑ cm	fits to	€
11529	52 x 59	66	baskets / pans GN 1/1	160,00

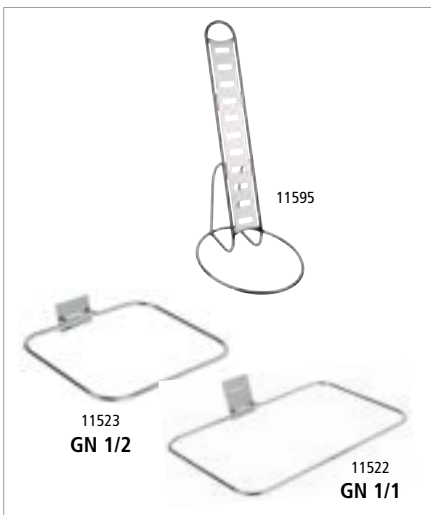

Einzelteile / spare parts / piezas sueltas / pièces détachées

Leitergestell / frame / marco de escalera / échelle support

11595	110,00
-------	--------

Einzelring GN 1/2 / single ring GN 1/2 / aro sencillo GN 1/2 / cercle simple GN 1/2

11523	20,00
-------	-------

Einzelring GN 1/1 / single ring GN 1/1 / aro sencillo GN 1/1 / cercle simple GN 1/1

11522	31,00
-------	-------

ETAGERES

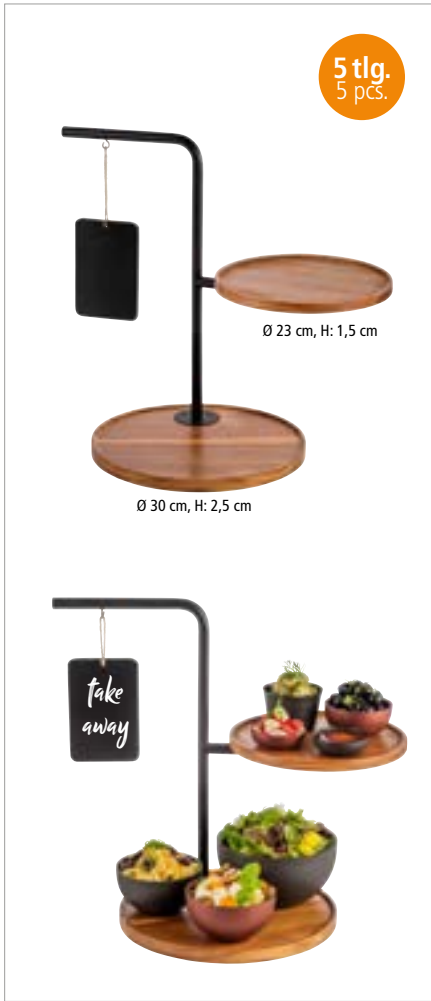

2-stufige Etagère „IRON“

2-tier tray
bandeja con dos alturas
étagère carré 2 hauteurs

1 Gestell aus schwarzem Metall
2 Akazienholzplatten: Ø 23 cm, H: 1,5 cm / Ø 30 cm, H: 2,5 cm
2 Beschriftungsschilder 15 x 10,5 cm

1 soporte metálico negro
2 tablas de madera de acacia: Ø 23 cm, H: 1,5 cm / Ø 30 cm, H: 2,5 cm
2 etiquetas de inscripción 15 x 10,5 cm

1 support métallique noir
2 panneaux en bois d'acacia: Ø 23 cm, H: 1,5 cm / Ø 30 cm, H: 2,5 cm
2 étiquettes d'inscription 15 x 10,5 cm



	cm	↑ cm	€/ set
30334	47 x 30	44	84,00

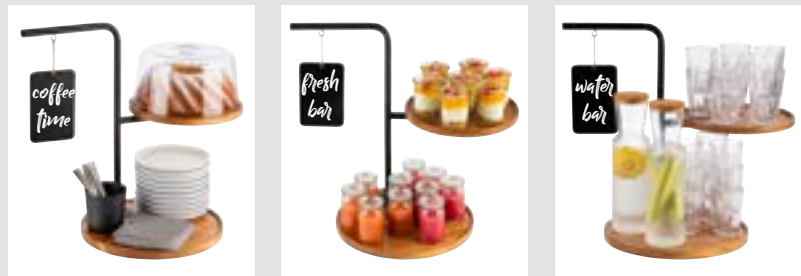

Präsentationsmöglichkeiten
presentation examples



2-stufige Etagère

2-tier tray
soporte 2 alturas
étagère 2 niveaux

1 Gestell aus Metall schwarz, mit Antirutschfüßchen,
2 herausnehmbare Bretter aus geöltem Akazienholz (34,5 x 20,5 x 1,5 cm) / (34,5 x 13 x 1,5 cm)
8 Beschriftungsschilder (8 x 4 cm)

1 frame made of black metal with non-slip feet,
2 removable trays made of acacia wood (34,5 x 20,5 x 1,5 cm) / (34,5 x 13 x 1,5 cm)
8 labelling plates (8 x 4 cm)

1 soporte metálico, negro con pies antideslizantes,
2 bandejas extraíbles de madera de acacia (34,5 x 20,5 x 1,5 cm) / (34,5 x 13 x 1,5 cm)
8 etiquetas (8 x 4 cm)

1 support métallique noir avec pieds antidérapants,
2 planches amovibles en bois d'acacia (34,5 x 20,5 x 1,5 cm) / (34,5 x 13 x 1,5 cm)
8 étiquettes (8 x 4 cm)



	cm	↑ cm	€/ set
30339	35,5 x 21	40	59,00



Präsentationsmöglichkeiten
presentation examples



mit Antirutschfüßchen
with non-slip feet

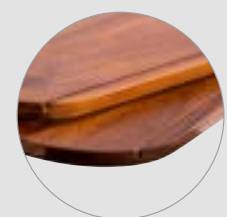

geöltes Akazienholz
oiled acacia wood



1 x Gestell / 1 x frame



2 x Korb / 2 x basket

5 tlg.
5 pcs.



2 x Tablett / 2 x tray



Haube / cover 11056



Korb / basket 30337



Tablett / tray 85099



Tablett / tray 30338

2-stufige Etagère „ALL-ROUNDER“, 5-teilig

2-tier tray, 5 pcs.

soporte 2 alturas, set de 5
étagère 2 niveaux, set de 5

5 teiliges Set:

- 1 Gestell aus Metall schwarz, mit Antirutschfüßchen,
- 2 Körbe aus Metall schwarz je 29 x 16 cm, H: 7 cm,
- 2 herausnehmbare Bretter aus geöltem Akazienholz je 28,5 x 15,5 cm, H: 1,5 cm

5 pcs.:

- 1 frame made of black metal with non-slip feet,
- 2 removable baskets of black metal each 29 x 16 cm, H: 7 cm,
- 2 boards of oiled acacia wood each 28,5 x 15,5 cm, H: 1,5 cm

set de 5:

- 1 soporte metálico, negro con pies antideslizantes,
- 2 cestas metálicas negras, cada una de 29 x 16 cm, H: 7 cm,
- 2 tablas de madera de acacia aceiteada 28,5 x 15,5 cm, H: 1,5 cm

set de 5:

- 1 support métallique noir avec pieds antidérapants,
- 2 paniers métalliques noirs, chacune 29 x 16 cm, H: 7 cm,
- 2 planches d'acacia huilé, chacune 28,5 x 15,5 cm, H: 1,5 cm



	cm	↑ cm	€ / set
30336	31 x 17	37,5	64,00



multifunktional,
ideal als

- Frühstück-Etagère
- Vorspeisen-Etagère
- Kuchen-Etagère
- Brot-Etagère
- Gebäck-Etagère
- Früchte-Etagère

Präsentationsmöglichkeiten
presentation examples

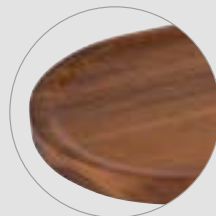

geöltes Akazienholz
oiled acacia wood



mit Antirutschfüßchen
with non-slip feet

Korb / basket / cesta / corbeille

	cm	↑ cm	Farbe / Colour	€
30337	29 x 16	7	■	19,00

Servierbrett aus Akazienholz / serving board of acacia wood / tabla de servir de madera de acacia / planche de service en bois d'acacia

	cm	↑ cm	Farbe / Colour	€
30338	28,5 x 15,5	3,5	■	6,60

Melamintablett / melamine tray / bandeja de melamina / plateau en mélamine

	cm	↑ cm	Farbe / Colour	€
85099 ^{NEW}	28,0 x 15,5	1,0	■	13,00

Haube / cover / campana / cloche

	cm	↑ cm	€
11056	26,0 x 12,0	10,0	6,00

NEW

ETAGERES



Serviergestell, 2-stufig

serving stand, 2-tier
soporte platos, 2 alturas
présentoir, 2 hauteurs

3 tlg. Set: 1 Gestell aus Akazienholz, 2 Schieferplatten, zusammenklappbar

3 pcs.: 1 stand acacia wood, 2 slate trays, foldable

set de 3: 1 soporte madera de acacia, 2 bandejas de pizarra, plegable

set de 3: 1 présentoir en bois d'acacia, 2 plateaux en ardoise naturelle, pliable



zusammenklappbar
foldable

	cm	↑ cm	€/ set
00958	36,5	34 x 26,5	38,80



High Tea Rack

High Tea Rack
rack de té alto
étagère à thé avec anse supérieure

Rubberwood dunkelbraun, Edelstahlgriff, 4 große Fächer 15 x 10 x 10 cm, 3 kleine Fächer 9,5 x 9,5 x 10 cm

rubber wood in dark brown, stainless handle, 4 big compartments 15 x 10 x 10 cm, 3 small compartments 9,5 x 9,5 x 10 cm

madera marrón oscura, mango de acero inoxidable, 4 compartimentos grandes 15 x 10 x 10 cm, 3 compartimentos pequeños 9,5 x 9,5 x 10 cm

bois marron foncé, poignée en acier inox, 4 compartiments grands 15 x 10 x 10 cm, 3 compartiments petits 9,5 x 9,5 x 10 cm



	cm	↑ cm	€
33210	34 x 10	38	40,00



Brezel- oder Wurstständer

pretzel-/ sausage stand
soporte para pretzels/ embutidos
support à bretzel ou à saucissons

Verkaufsständer Buchenholz versiegelt, bestens geeignet für die Präsentation von Brezeln, Würstchen, etc., Fuß Ø 22 cm

beech wood, ideal to present pretzels, sausages, etc., , base Ø 22 cm

soporte de madera de haya, ideal para presentar pretzels, salchicas, etc., base Ø 22 cm

support en bois de hêtre, pour la présentation de bretzels, saucisses, etc. pied Ø 22 cm



	Ø cm	↑ cm	€
79553	28	50	21,00

Hygieneschutz für Brezelständer / hygienic cover / campana higiénica antialiento / pare-haleine

	cm	↑ cm	€
11557	20 x 20 x 20	50	22,00
11558	15 x 20 x 15	50	20,00



Hobel für Käse und Schokolade

cheese / choco curler
rizador para queso y chocolate
frisette pour fromage et chocolat

3-teilig: Platte Buchenholz versiegelt Ø 22 cm mit senkrechtem Stift

+ Hobel 7 cm + Haube Ø 15 x 10 cm, für Käse und Schokolade

3 pcs.: wooden base Ø 22 cm with vertical bolt + plough 7 cm
+ cover Ø 15 x 10 cm, for cheese and chocolate

set de 3: base de madera Ø 22 cm, con eje vertical de 7 cm

+ campana Ø 15 x 10 cm, para „rizar“ queso y chocolate

set de 3: base bois Ø 22 cm, axe vertical ht. 7 cm, cloche Ø 15 x ht 10 cm,

pour „friser“ le fromage ou le chocolat



	Ø cm	↑ cm	€
50002	22	15	19,50

SERVING STANDS



2-stufige Etagère

2-tier étagère
cesta doble 2 alturas
étagère 2 paniers

Griff aus Holz, Körbe aus Metall schwarz,
oberer Korb (Ø 22 cm, H: 6 cm), unterer Korb (Ø 26 cm, H: 8 cm)

wooden handle, baskets made of metal black,
upper basket (Ø 22 cm, H: 6 cm), lower basket (Ø 26 cm, H: 8 cm)

asa de madera, cestas de metal negro,
cesta superior (Ø 22 cm, H: 6 cm), cesta inferior (Ø 26 cm, H: 8 cm)

manche en bois, corbeilles en métal noir,
corbeille supérieure (Ø 22 cm, H: 6 cm), corbeille inférieure (Ø 26 cm, H: 8 cm)



	Ø cm	↑ cm	€
30335	26	48	42,00



Präsentationsmöglichkeiten
presentation examples

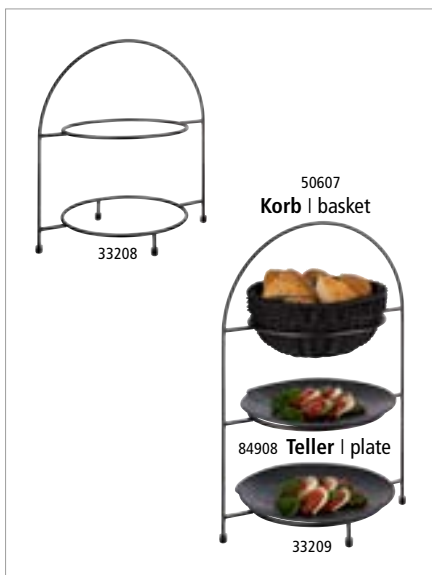

Serviergestell „INDUSTRIAL“

servicing stand
soporte platos
présentoir à assiettes

für Teller max. Ø 27 cm, innerer Ring Ø 18 cm, Lieferung ohne Teller

for plates max. Ø 27 cm, circle inside Ø 18 cm, delivery without dishes

para platos máx. Ø 27 cm, aro interior Ø 18 cm, se entrega sin platos

pour assiettes Ø 27 cm maxi., anneau intérieur Ø 18 cm, livré sans assiettes



	cm	↑ cm	passend für Tellerabdeckhauben / suitable for plate covers	€
33208	29 x 19,5	30	2 Teller Ø 27 cm innerer Ring Ø 18 cm	11051, 11052 33,00
33209	29 x 19,5	43	3 Teller Ø 27 cm innerer Ring Ø 18 cm	11051, 11052 42,00



Serviergestell

serving stand
soporte platos
présentoir à assiettes



für 3 Teller max. Ø 27 cm, innerer Ring Ø 18 cm
for 3 plates max. Ø 27 cm, circle inside Ø 18 cm
para 3 platos Ø 27 cm, aro interior Ø 18 cm
pour 3 assiettes maxi Ø 27 cm, anneau intérieur Ø 18 cm

	cm	↑ cm	€
33217	33 x 24	43	52,00

für 2 Teller max. Ø 27 cm, innerer Ring Ø 18 cm, Lieferung ohne Teller
for 2 plates max. Ø 27 cm, circle inside Ø 18 cm, without dishes
para 2 platos Ø 27 cm, aro interior Ø 18 cm, se entrega sin platos
pour 2 assiettes maxi Ø 27 cm, anneau intérieur Ø 18 cm, livré sans assiettes

	cm	↑ cm	€
33214	33 x 23,5	30	41,00

für 3 Teller max. Ø 17 cm, innerer Ring Ø 10,5 cm
for 3 plates max. Ø 17 cm, circle inside Ø 10,5 cm
para 3 platos Ø 17 cm, aro interior Ø 10,5 cm
pour 3 assiettes maxi Ø 17 cm, anneau intérieur Ø 10,5 cm

	cm	↑ cm	€
33216	22,5 x 16,5	25,5	32,80



Serviergestell

serving stand
soporte platos
présentoir à assiettes



für 3 Teller max. Ø 17 cm, innerer Ring Ø 10,5 cm
for 3 plates max. Ø 17 cm, circle inside Ø 10,5 cm
para 3 platos Ø 17 cm, aro interior Ø 10,5 cm
pour 3 assiettes maxi Ø 17 cm, anneau intérieur Ø 10,5 cm

	cm	↑ cm	Farbe / Colour	€
33215	18,5 x 15,5	26		25,60
33211	18,5 x 15,5	26		28,00

für 3 Teller max. Ø 27 cm, innerer Ring Ø 18 cm
for 3 plates max. Ø 27 cm, circle inside Ø 18 cm
para 3 platos Ø 27 cm, aro interior Ø 18 cm
pour 3 assiettes maxi Ø 27 cm, anneau intérieur Ø 18 cm

	cm	↑ cm	Farbe / Colour	€
33220	29 x 19,5	43		42,00
33212	29 x 19,5	43		45,00



Serviergestell

serving stand
soporte platos
présentoir à assiettes



für 2 Teller max. Ø 27 cm, innerer Ring Ø 18 cm
for 2 plates max. Ø 27 cm, circle inside Ø 18 cm
para 2 platos Ø 27 cm, aro interior Ø 18 cm
pour 2 assiettes maxi Ø 27 cm, anneau intérieur Ø 18 cm

	cm	↑ cm	Farbe / Colour	€
33219	29 x 19,5	30		33,80



Etagère „FINESSE“

etagère
frutero
étagère



vergoldeter Messing-Kugelgriff, einfache Montage

gold plated knob, easy to assemble

botón dorado, fácil de montar

bouton doré, montage facile

	Ø cm	↑ cm		€
33248	48 / 38 / 32	50	3-stufig / 3-tier 3 alturas / 3 niveaux	99,00
33238	38 / 32	30	2-stufig / 2-tier 2 alturas / 2 niveaux	62,00

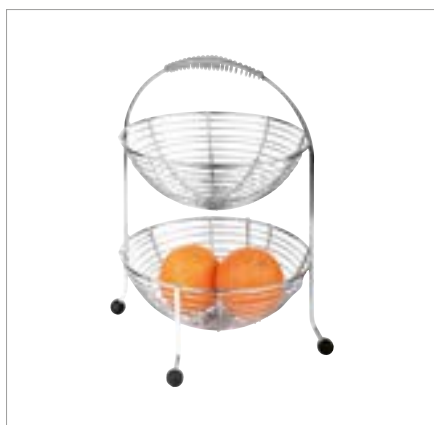

Etagère

etagère
frutero
corbeille à fruits



ergonomischer Griff, stehend auf schwarzen Antirutsch-Füßen

ergonomic handle, with non-slip feet

asa ergonómica, con pies antideslizantes color negro

anse ergonomique, avec pieds antidérapants noirs

	cm	↑ cm	€
30325	30 x 30	35,5	19,00



3-stufige Etagère

3-tier tray
bandeja con tres alturas
étagère carré 3 hauteurs



Naturschieferplatte, Akazienholz

natural slate tray, wood akazie

bandeja de pizarra natural, madera de acacia

plateau ardoise naturelle, bois d'acacia

	Ø cm	↑ cm	* mm	€
00960	30 / 25 / 20	34	6 - 9	30,00



2-stufige Etagère

2-tier tray
bandeja dos alturas
étagère carré 2 hauteurs



Naturschiefer

natural slate tray

bandeja de pizarra natural

plateau ardoise naturelle

	Ø cm	↑ cm	* mm	€
00989	25 / 20	24	6 - 9	15,30

CUTTING BOARDS



00954
Box

00953
Schneidebrett

83615
Tablett



Tablett „BROTSTATION“

tray
bandeja
plateau

mit Antirutschfüßchen
with non-slip feet
con pies antideslizantes
avec pieds antidérapants



	cm	↑ cm	€
83615	59,5 x 35,5	3,5	42,00



00953
Schneidebrett

83615
Tablett

Brotschneidebrett „BROTSTATION“

cutting board
tabla de corte
planche à découper

Buchenholz
beech
haya
hêtre



	cm	↑ cm	€
00953	52 x 34	2	37,00

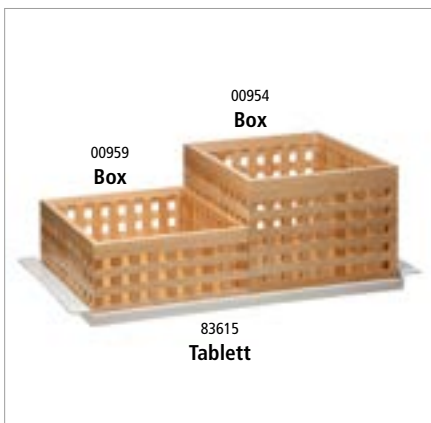

00954
Box

00959
Box

83615
Tablett

Box „BROTSTATION“

box
caja de pan
boîte à pain

Buchenholz
beech
haya
hêtre



	cm	↑ cm	€
00959	34 x 26	12,5	48,00
00954	34 x 26	20,0	59,00



Brotschneidebrett „PROFI“

cutting board
tabla de cortar
planche à découper



Eichenholz / oak wood / mader de roble / bois de chêne

	cm	↑ cm		€
00806	58 x 37,5	4		110,00



Brotschneidebrett

cutting board
tabla de cortar
planche à découper



Walnussholz / walnut wood / mader de nogal / bois de noyer

	cm	↑ cm	GN	€
00911	35,4 x 32,5	3,5	2/3	77,00

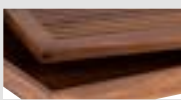

praktisches Krümfach
practical crump shelf



praktisches Krümfach
practical crump shelf

Brotschneidebrett „LETTER“

cutting board
tabla de cortar
planche à découper



Akazienholz / acacia wood / mader de acacia / bois d'acacia

	cm	↑ cm		€
00886	48 x 34	3,5		36,00



00885

Brotschneidebrett

cutting board
tabla de cortar
planche à découper



Akazienholz / acacia wood / mader de acacia / bois d'acacia

	cm	↑ cm	GN	€
00883	47,5 x 32,0	2		30,00
00884	53,0 x 32,5	2	1/1	31,00
00885	60,0 x 40,0	2		36,00



praktisches Krümfach
practical crump shelf



00957

Brotschneidebrett

cutting board
tabla de cortar
planche à découper



Rubberwood / rubberwood / mader de caucho / bois d'hévéa

	cm	↑ cm	GN	€
00955	47,5 x 32,0	2		27,00
00956	53,0 x 32,5	2	1/1	29,00
00957	60,0 x 40,0	2		34,00



praktisches Krümfach
practical crump shelf

BUFFET GUARD

3 Höhen einstellbar
3 heights adjustable



schwenkbar
swivelling

Servierbeispiel
presentation example

85068
2 x GN 1/2

85067
1 x GN 1/1



Hygieneschutz „BUFFET GUARD“

sneeze guard
protector anti aliento
pare-haleine



- transparente, höhenverstellbare Acrylplatte 80 x 53 cm
- Neigungswinkel stufenlos einstellbar
- transparent, height-adjustable acrylic plate 80 x 53 cm
- tilt angle continuously adjustable
- placa acrílica transparente y de altura ajustable 80 x 53 cm
- el ángulo de inclinación es infinitamente variable
- plaque en acrylique transparente 80 x 53 cm et réglable en hauteur
- angle d'inclinaison variable à l'infini

	cm	↑ cm	mm	Fuß / base	€
98120	93 x 53	50,5	5	Metall schwarz / metal black	159,00



Antirutschfüßchen
non-slip feet



Der Neigungswinkel der Acrylplatte ist flexibel einstellbar
the angle of inclination of the acrylic plate is flexibly adjustable

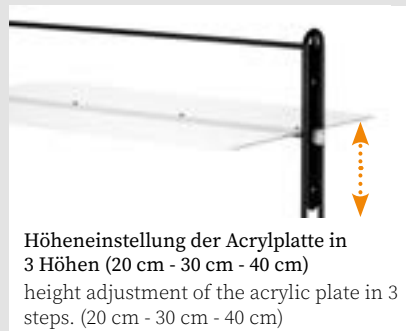

Höheneinstellung der Acrylplatte in 3 Höhen (20 cm - 30 cm - 40 cm)
height adjustment of the acrylic plate in 3 steps. (20 cm - 30 cm - 40 cm)



Schalen / bowls 25 x 25 cm
6 x 83918

Anwendungsbeispiel
application example



Lieferung erfolgt demontiert
delivery takes place disassembled

DRAWER SET



3 tlg.
3 pcs.



mit Antirutsch Füßchen
with non-slip feet



Schubladen Set, 3-teilig

drawer set, 3 pcs.
cajonera, set de 3
set tiroir, set de 3

3-teiliges Set:

- 1 Ständer aus Metall schwarz
- 1 Schublade mit Griff schwarz
- 1 Schneidebrett aus geöltem Walnussholz

3 pcs. set:

- 1 stand made of metal black
- 1 drawer with handle black
- 1 oiled walnut wood cutting board

set de 3:

- 1 soporte de metal negro
- 1 cajón con asa negra
- 1 tabla de cortar de madera de nogal engrasada

set de 3:

- 1 support métallique noir
- 1 tiroir avec poignée noire
- 1 planche à découper en bois de noyer huilé



	cm	↑ cm	€ / set
00910	35,4 x 32,5	20	174,00



Anwendungsbeispiele
application examples

Einzelteile / parts / piezas / pièces

	cm	↑ cm		€
00911	35,4 x 32,5	3,5	Schneidebrett / cutting board	77,00
00912	34,0 x 32,0	17,5	Schublade, Griff schwarz / drawer, handle black	82,00
00914	34,0 x 32,0	17,5	Schublade, Griff chrom / drawer, handle chrome	82,00
15503	35,4 x 32,5	17,6	GN Buffetständer chrom / GN buffet stand chrome	29,00
15506	35,4 x 32,5	17,6	GN Buffetständer schwarz/ GN buffet stand black	22,80

SNACKPRESENTER



Snackpresenter

snackpresenter
dispensador de bocadillos
présentoir à sandwiches
mit Safrille und Griffmulde, passend für Vitrine 11888
with recessed grip, suitable for showcase 11888
asa moldeada, apto para la vitrina 11888
anse moulée, apte pour vitrine 11888



	cm	↑ cm		€
11887	29 x 19	6,5	3 Mulden / 3 compartments 3 compartimentos / 3 compartments	22,00
11889	60 x 19	7,5	6 Mulden / 6 compartments 6 compartimentos / 6 compartments	25,00

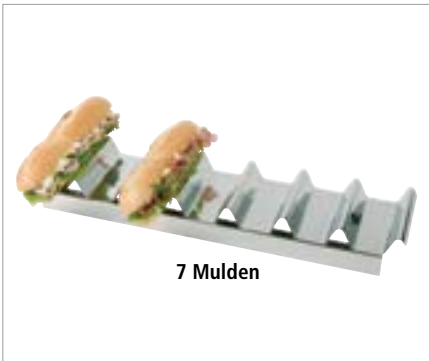

Snackpresenter

snackpresenter
dispensador de bocadillos
présentoir à sandwiches
hochglanzpoliert, mit Griffmulde, für 7 Baguettes
mirror polished, with recessed grip, for 7 baguettes
pulido brillante, con asa empotrada, ideal para 7 bocadillos
poli brillant, avec poignée encastrée, parfait pour 7 sandwiches



	cm	↑ cm		€
11891	47,5 x 10,5	6		32,00

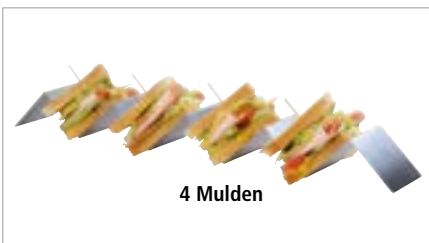

Snackpresenter

snackpresenter
dispensador de bocadillos
présentoir à sandwiches



	cm	↑ cm		€
11969	56 x 8	5,5		14,00



Vitrine / Thekenaufsatz

showcase
vitrina de mostrador
vitrine de comptoir
rutschfest, aus einem Teil gefertigt
non-slip, monoblock produced
antideslizante, fabricado en 1 pieza
antidérapante, fabriquée en une seule pièce



	cm	↑ cm		€
11888	63,5 x 25	25		89,00



Hygieneschutz
hygienic cover
campana higiénica antialiento
pare-haleine



	cm	↑ cm	€
11556	82 x 42	45	214,00



Brötchenspender
roll dispenser
dispensador de panecillos
distributeur de petits pains



hygienisch und einfach zu reinigen, mit Krümelschale
hygienic and easy to clean, with crumb tray
higiénico y fácil de limpiar, con bandeja para migas
hygiénique et facile à laver, avec plat ramasse-miettes

	cm	↑ cm		€
11572	32,5 x 27,5	42	für ca. 45-50 Brötchen / for approx. 45-50 rolls para 45-50 panecillos / pour 45-50 petits pains	199,00
11573	32,5 x 27,5	56	für ca. 65-70 Brötchen / for approx. 65-70 rolls para 65-70 panecillos / pour 65-70 petits pains	229,00



Buffetgestell
buffet stand
soporte para buffet
présentoir buffet



3-stufig, Rubberwood, geeignet für Körbe, platzsparend zusammenklappbar
3-tier, rubberwood, usable for baskets, can be pushed together for place saving
3 alturas, madera de caucho, apto para cestas, se puede plegar para ahorrar espacio
3 hauteurs, bois d'hévéa, pour corbeilles, la structure s'ouvre ou se ferme pour réduire l'encombrement

	cm	↑ cm	€
33232	59 x 30,5	59	22,00

Tisch- und Buffetkorb, rund „ECONOMIC“ / buffet basket, round / cesta de buffet redonda / corbeille de buffet ronde

	Ø cm	↑ cm	Farbe / Colour	€
40144	39,0	10,0		19,00



Buffetgestell, 3-teilig
buffet stand, 3 pcs.
expositor de buffet, set de 3
présentoir buffet, set de 3



Rubberwood, 3-teilig:
1. Fach 40 x 40 cm x H 33 cm;
2. Fach 40 x 37 cm x H 20 cm;
3. Fach 40 x 34 cm x H 9 cm

rubberwood, 3 pcs.:
1. 40 x 40 cm x H 33 cm;
2. 40 x 37 cm x H 20 cm;
3. 40 x 34 cm x H 9 cm

	cm	↑ cm	Farbe / Colour	Wenge	€
11607	40 x 40	33			200,00



Neigungswinkel stufenlos einstellbar
inclination angle continuously adjustable

für 3 versch. Haubengrößen
for 3 different cover sizes

06519 Ø 21 cm
06520 Ø 30 cm
06521 Ø 36 cm



Haubenthalterung „FLEXIBLE“

cover holder
soporte de la campana
support de la cloche



Bei dieser Haubenthalterung wird die Haube am Griff in die Vorrichtung gesteckt.
Für APS-Hauben geeignet!

With this cover holder, the cover is inserted into the device by the handle.
Suitable for APS covers!

Con este soporte de campana, la campana se cuelga simplemente por el asa.
¡Para campanas de APS!

Avec ce support, la cloche s'accroche simplement par la poignée.
Pour cloches APS!

	cm	↑ cm	€
33288	35,5 x 30	39	129,00



Anwendungsbeispiele
application examples

2 tlg.
2 pcs.



24 cm

Haube | cover
Ø 16 cm

Tablett | tray
Ø 18,5 cm



Tablett mit Haube

tray with cover
bandeja con campana
plateau avec cloche



2 teiliges Set:

- 1 Tablett aus geöltem Buchenholz (Ø 18,5 cm, H: 2,5 cm)
- 1 Glas-Haube (Ø 16 cm, H: 22,5 cm)

2 pcs.:

- 1 tray of oiled beech wood (Ø 18,5 cm, H: 2,5 cm)
- 1 glass cover (Ø 16 cm, H: 22,5 cm)

set de 2:

- 1 bandeja de madera de haya (Ø 18,5 cm, H: 2,5 cm)
- 1 campana de cristal (Ø 16 cm, H: 22,5 cm)

set de 2:

- 1 plateau de bois de hêtre (Ø 18,5 cm, H : 2,5 cm)
- 1 couvercle en verre (Ø 16 cm, H : 22,5 cm)

	Ø cm	↑ cm	€/ set
00830	18,5	24	36,00



Präsentationsmöglichkeit
presentation example



3 tlg.
3 pcs.

Multi Rack
multi rack
dispensador en escalera
support multiple



2-stufig, 3-teilig:
• 1 Gestell matt poliert
• 2 Schütten aus transparent gefroretetem Kunststoff, je ca. 1 Liter

2-tier, 3 pcs.:
• 1 frame matt polished
• 2 bowls frosted plastic, approx. 1 liter
2 alturas - set de 3:
• 1 soporte pulido mate
• 2 cuencos de plástico glaseado, aprox. 1 litro

2 niveaux - set de 3:
• 1 support poli mat
• 2 bols en plastique mat, approx. 1 litre

	cm	↑ cm	€ / set
11442	19 x 24	28	42,00



4 tlg.
4 pcs.

Multi Rack
multi rack
dispensador en escalera
support multiple



3-stufig, 4-teilig:
• 1 Gestell matt poliert
• 3 Schütten aus transparent gefroretetem Kunststoff, je ca. 1 Liter

3-tier, 4 pcs.:
• 1 frame matt polished
• 3 bowls frosted plastic, approx. 1 liter
3 alturas, set de 4:
• 1 soporte pulido mate
• 3 cuencos de plástico glaseado, aprox. 1 litro

3 niveaux - set de 4:
• 1 support poli mat
• 3 bols en plastique mat, approx. 1 litre

	cm	↑ cm	€ / set
11444	19 x 24	41	48,00



4 tlg.
4 pcs.

Multi Rack
multi rack
dispensador en escalera
support multiple



4-stufig, 5-teilig:
• 1 Gestell matt poliert
• 4 Schütten aus transparent gefroretetem Kunststoff, je ca. 1 Liter

4-tier, 5 pcs.:
• 1 frame matt polished
• 4 bowls frosted plastic, approx. 1 liter
4 alturas, set de 5:
• 1 soporte pulido mate
• 4 cuencos de plástico glaseado, aprox. 1 litro

4 niveaux - set de 5:
• 1 support poli mat
• 4 bols en plastique mat, approx. 1 litre

	cm	↑ cm	€ / set
11446	19 x 31	53	62,00



Ergänzung für alle Multi-Racks
suplemento para todos los dispensadores
compléments pour support multi-rack



Schütte / canister / cuenco / bol

	cm	↑ cm	ltr.	€
11455	19,5 x 16,5	10,5	1,0	7,20



BUFFET STANDS



Buffetständer „STAR“

buffet stand
soporte para buffet
présentoire buffet

Metall, mit schwarzer Antirutschbeschichtung

metal, with black anti-slide coating
metal, con revestimiento antideslizante negro
métal, avec revêtement antidérapant noir



	↑ cm	€
33260	8	14,80
33261	12	17,50
33262	18	20,00



Buffetständer „MULTI“

buffet stand
soporte para buffet
présentoir buffet

Metall, mit schwarzer Antirutschbeschichtung

metal, with black anti-slide coating
metal, con revestimiento antideslizante negro
métal, avec revêtement antidérapant noir



	Ø cm	↑ cm	€
33269	15,5 / 18	8	10,90
33270	15,5 / 18	10	13,00
33271	15,5 / 18	18	16,70

	cm	↑ cm	€
33249	18 x 18	5	9,60
33250	18 x 18	8	3,00
33251	18 x 18	10	16,00
33252	18 x 18	18	18,90



Buffetständer „PRISMA“

buffet stand
soporte para buffet
présentoir buffet

Metall, mit schwarzer Antirutschbeschichtung

metal, with black anti-slide coating
metal, con revestimiento antideslizante negro
métal, avec revêtement antidérapant noir



	Ø cm	↑ cm	€
33272	20	10,5	10,20
33273	20	20,0	14,50



Buffetständer „KING“

buffet stand
soporte para buffet
présentoir buffet



kein Verrutschen, Arme und Boden sind mit Antirutschflächen ausgestattet, schwere standsichere Qualität, Fuß dient als Löffelablage

the arms and base are equipped with non-slip surfaces, stable quality, base serves as spoon holder

revestimiento antideslizante en las puntas de los brazos y en la base, estable y alta calidad, la base sirve como reposacuchara

revêtement antidérapant sur les extrémités des 3 pieds et sur la base, robuste, stable et bonne qualité, la base sert de support pour les couverts

	Ø cm	↑ cm	€
03622	15	14	44,00
03623	15	21	48,00

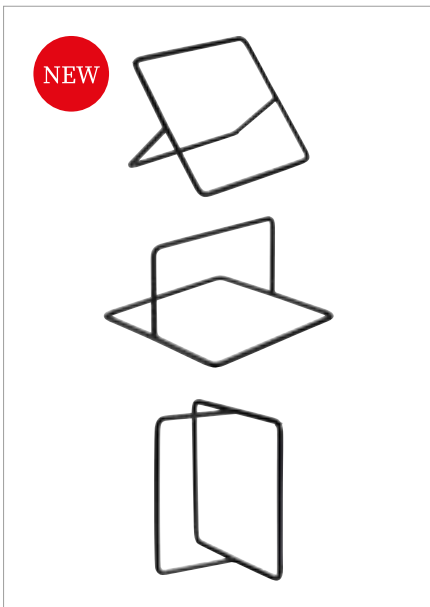

NEW

Buffetständer „SQUARE“

buffet stand
soporte para buffet
présentoir buffet



Metall, mit schwarzer Antirutschbeschichtung

metal, with black anti-slide coating

metal, con revestimiento antideslizante negro

métal, avec revêtement antidérapant noir

	cm	↑ cm	€
33305	12 x 12	7	7,00



Präsentationsmöglichkeit | presentation example



NEW

Buffetständer „PERFECTO“

buffet stand
soporte para buffet
présentoir buffet



Metall, mit schwarzer Antirutschbeschichtung

metal, with black anti-slide coating

metal, con revestimiento antideslizante negro

métal, avec revêtement antidérapant noir

	cm	↑ cm	fits to	€
33304	19 x 23	40,5	33202, 33303	22,00



NEW

Buffetständer „FRIDA“

buffet stand
soporte para buffet
présentoir buffet



Metall, mit schwarzer Antirutschbeschichtung

metal, with black anti-slide coating

metal, con revestimiento antideslizante negro

métal, avec revêtement antidérapant noir

	Ø cm	↑ cm	fits to	€
33282	23 / 30,5	17	85230, 85231	42,00

BUFFET STANDS

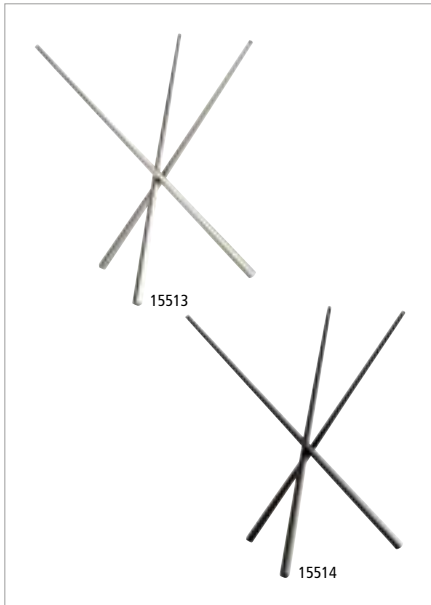

Buffetständer „ASIA PLUS“

buffet stand
soporte para buffet
présentoir buffet



	Ø cm	↑ cm	Farbe / Colour	€
15513	20,5 / 16,5	20		16,80
15514	20,5 / 16,5	20		15,60



Präsentationsmöglichkeit
presentation example



Buffetständer

buffet stand
expositor de buffet
présentoir buffet



Akazienholz
acacia wood
madera de acacia
bois d'acacia

	Ø cm	↑ cm	€
33255	15	10	17,00
33256	25	15	21,00



Präsentationsmöglichkeit
presentation example



Buffetständer „WOOD“

buffet stand
soporte para buffet
présentoire buffet



Akazienholz, liegend oder stehend, variable Nutzungsmöglichkeiten
acacia wood, usable by lying or standing, variable usage possibilities
madera de acacia, se puede usar tumbado o de pie, opciones de uso variable
bois d'acacia, possibilités d'utilisation variables

	cm	↑ cm	Farbe / Colour	€
33280	20 x 20	17,5		11,80
33281	20 x 20	17,5		11,80



liegend oder stehend, variable Nutzungsmöglichkeiten
vertically or horizontally, variable usage possibilities

HOCHSTAPLER



Distanzstücke erhöhen die Nutzhöhe auf 4 cm

GN 1/1 System-Tablett „PROFI LINE“

GN 1/1 tray
GN 1/1 bandeja
GN 1/1 plateau



Dekorrand, hochglanzpoliert, Griffe verchromt, Distanzstücke erhöhen die Nutzhöhe auf 4 cm
decor edge, mirror polished, chrome plated handles, spacers increase the useful height to 4 cm
borde decorado pulido brillante, asas cromadas, los separadores aumentan la altura útil a 4 cm
bord avec reliefs poli brillant, poignées chromées, les entretoises portent la hauteur utile à 4 cm

	cm	↑ cm	GN	€
11300	53 x 32,5	5,5	1/1	46,00

11150
mit verchromten Griffen

11155
mit vergoldeten Griffen

GN 1/1 System-Tablett „BUFFET-STAR“

GN 1/1 tray
GN 1/1 bandeja
GN 1/1 plateau



Rand hochglanzpoliert, Distanzstücke erhöhen die Nutzhöhe auf 4 cm
mirror polished edge, spacers increase the useful height to 4 cm
borde pulido brillante, los separadores aumentan la altura útil a 4 cm
bord poli brillant, les entretoises portent la hauteur utile à 4 cm

	cm	↑ cm	GN	Griff / handle	€
11150	53 x 32,5	6,5	1/1	gold	37,00
11155	53 x 32,5	6,5	1/1	silver	40,00

für platzsparende Servieren, Lagern und Transportieren
for space-saving serving, storing and transporting

GN 1/1 System-Tablett „CLASSIC“

GN tray
GN bandeja
GN plat empilable système catering



Rand hochglanzpoliert, Distanzstücke erhöhen die Nutzhöhe auf 4 cm
mirror polished edge, spacers increase the useful height to 4 cm
borde pulido brillante, los separadores aumentan la altura útil a 4 cm
bord poli brillant, les entretoises portent la hauteur utile à 4 cm

	cm	↑ cm	GN	€
11295	53 x 32,5	5,0	1/1	39,00

11305
Haube / cover

11300
Tablett / tray

GN 1/1 Haube „HOCHSTAPLER“

GN 1/1 cover
GN 1/1 campana
GN 1/1 cloche

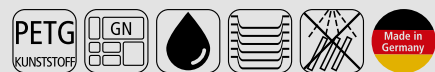

glasklarer Kunststoff, Haube fixiert sich auf dem Tablett, nahezu bruchfest
clear plastic, cover fixes itself on the tray, nearly unbreakable
plástico transparente, la tapa se fija a la bandeja para que no se deslice, resistente a la rotura
en plastique transparent, la cloche se fixe sur le dessous du plateau, résistant à la casse

	cm	↑ cm	fits to	GN	€
11305	53 x 32,5	9	11300, 11295	1/1	30,00



GN Behälter „PROFI LINE“

GN pan
GN cubeta
GN bac



	cm	↑ cm	GN	ltr.	€
11020	53,0 x 32,5	2,0	1/1	1,7	34,00
11040	53,0 x 32,5	4,0	1/1	3,4	37,00
11065	53,0 x 32,5	6,5	1/1	7,0	40,00
12065	32,5 x 26,5	6,5	1/2	3,3	26,00



GN Tablett „PROFI LINE“

GN tray
GN bandeja
GN plateau



mit glattem Rand / with smooth edge / borde liso / bord lisse

	cm	↑ cm	GN	€
11100	53,0 x 32,5	1,5	1/1	31,00
12100	32,5 x 26,5	1,5	1/2	17,80

mit Dekor-Rand / with decor-edge / con borde decorado / bords avec relief

	cm	↑ cm	GN	€
11000	53,0 x 32,5	1,5	1/1	31,00
12000	32,5 x 26,5	1,5	1/2	19,60

glatter schmaler Rand / smooth narrow edge / borde estrecho liso / bord étroit lisse

	cm	↑ cm	GN	€
11110	53,0 x 32,5	1,0	1/1	18,60



Tablett „PROFI LINE“

tray
bandeja
plateau



Dekorrand hochglanzpoliert
decor edge mirror polished
borde decorado pulido brillante
contour relief poli brillant

	Ø cm	↑ cm	€
11032	32	2,5	21,00
11038	38	2,5	31,00
11048	48	2,5	39,00



GN Abdeckhaube

GN cover
GN campana
GN cloche



	cm	↑ cm	✱ mm	GN	€
11041	32,5 x 26,5	9,5	3	1/2	23,00
11042	53,0 x 32,5	9,5	3	1/1	32,00
11043	32,5 x 17,6	10,5	3	1/3	17,00
11044	53,0 x 16,2	10,5	3	2/4	23,00



Tablett „SCHÖNER ESSEN“

tray
bandeja
plateau



mit Dekorrand, Griffe Zinkdruckguss verchromt, genietet

with decor edge, handles zinc alloy chrome plated, riveted

borde decorado, asas de fundición inyectada de cinc cromado, remachadas

bord décor, poignées en zamac chromé, rivetées

	cm	↑ cm	€
00082	52 x 31,0	3,0	16,00
00081	60 x 36,0	3,0	22,00
00084	75 x 44,5	3,0	38,00



Tablett „SCHÖNER ESSEN“

tray
bandeja
plateau



	cm	↑ cm	GN	€
00383	35,0 x 24,0	1,0		7,60
00382	42,0 x 31,0	1,0		10,60
00381	50,0 x 36,0	1,0		15,00
00384	63,5 x 44,5	1,0		29,00
00385	60,0 x 40,0	1,0		27,00
00388	53,0 x 32,5	1,0	1/1	17,00

leichte Ausführung 0,5 mm / light model / modelo ligero / qualité légère

	cm	↑ cm	€
03824	42,0 x 31,0	1,0	9,60



Tablett „SCHÖNER ESSEN“

tray
bandeja
plateau



	cm	↑ cm	€
00087	38 x 23	1,5	8,80



Tablett „SCHÖNER ESSEN“

tray
bandeja
plateau



	Ø cm	↑ cm	€
00075	31	1,0	7,50
00085	35	1,0	9,60



Tablett mit Haube „SCHÖNER ESSEN“

tray with cover
bandeja con campana
plateau avec cloche



	cm	↑ cm	€
38202	42 x 31	8	16,80

Haube / cover / campana / cloche

	cm	↑ cm	€
08201	36,5 x 26,0	7,5	5,40

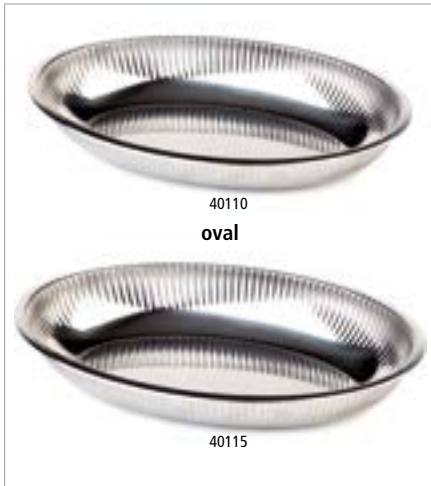

Schale

bowl
cuenco
bol

ingerollter Rand

rolled edge
borde enrollado
bord roulé



	cm	↑ cm	ltr.	€
40110	26,5 x 18,5	4,0	0,8	8,60
40115	31,0 x 21,0	4,5	1,3	12,40



Servierpfanne

pan
fuente para la mesa
plat pour la table

mit vergoldeten Edelstahlgriffen, 1 mm dick

with gold-plated stainless steel handles, 1 mm thick
con asas doradas de acero inoxidable de 1 mm de grosor
avec poignées dorées en acier inox, 1 mm d'épaisseur



	cm	↑ cm	ltr.	€
61190	19	3,5	0,7	16,40
61280	28	4,0	2,0	24,00
61400	40	5,0	4,5	64,00
60270	26,5 x 19,5	3	0,8	18,40
60310	31,0 x 21,5	3	1,2	23,00



Edelstahltablett „FOCUS“

tray
bandeja
plateau



	cm	↑ cm	€
09010	43,5 x 32,5	1,5	20,00

Rolltophaube „FOCUS“ / rolltop cover / campana abatible / cloche basculante

	cm	↑ cm	€
09013	44 x 33,5	17	28,00



Tablett „ELEGANCE“

tray
bandeja
plateau



	cm	↑ cm	€
02310	41 x 26	1,0	13,40
02311	48 x 30	1,0	17,00
02312	60 x 37	1,0	26,00



Tablett „FINESSE“

tray
bandeja
plateau



verchromte Messinggriffe / chrome plated brass handles / asas plateadas de latón / poignées en laiton chromées

	Ø cm	↑ cm	€
01738	38	1,5	24,00
01748	48	1,5	39,00



Tablett „FINESSE“

tray
bandeja
plateau



verchromte Messinggriffe / chrome plated brass handles / asas plateadas de latón / poignées en laiton chromées

	cm	↑ cm	€
01712	44 x 31	1,5	22,40
01711	52 x 38	1,5	28,00
01710	60 x 42	1,5	44,00
01709	70 x 48	1,5	56,00



Tablett „FINESSE“

tray
bandeja
plateau



	cm	↑ cm	€
01322	42 x 30	2,5	14,90
01323	50 x 36	2,5	21,60
01324	60 x 41	2,5	30,00
01325	70 x 46	2,5	44,00



Tablett „FINESSE“

tray
bandeja
plateau



	Ø cm	↑ cm	€
01332	32,0	1,0	9,40
01335	35,0	1,0	11,00
01338	38,0	1,0	12,40
01348	48,0	1,0	24,00
01349	48,5	1,0	24,00



Tablett „FINESSE“

tray
bandeja
plateau



	cm	↑ cm	€
01314	30 x 24	1,0	8,60
01313	35 x 24	1,0	9,80
01317	39 x 26	1,0	11,00
01312	42 x 31	1,0	12,40
01318	48 x 30	1,0	11,80
01311	50 x 38	1,0	17,20
01310	58 x 42	1,0	29,00
01309	68 x 48	1,0	41,00



Tablett mit Haube „FINESSE“

tray with cover
bandeja con campana
plateau avec cloche

2-teilig: Tablett aus Edelstahl + Haube

2 pcs.: stainless steel tray + cover
set de 2: bandeja de acero inoxidable + campana
set de 2: plateau en acier inox + cloche



	cm	↑ cm	€
13122	42 x 31	8,5	22,00



Tablett mit Haube „FINESSE“

tray with cover
bandeja con campana
plateau avec cloche

2-teilig: Tablett aus Edelstahl + Haube

2 pcs.: stainless steel tray + cover
set de 2: bandeja de acero inoxidable + campana
set de 2: plateau en acier inox + cloche



	Ø cm	↑ cm	€
13622	22	9,5	7,80



Tablett mit Haube „FINESSE“

tray with cover
bandeja con campana
plateau avec cloche

2-teilig: Tablett aus Edelstahl + Haube

2 pcs.: stainless steel tray + cover
set de 2: bandeja de acero inoxidable + campana
set de 2: plateau en acier inox + cloche



	Ø cm	↑ cm	Ø cm Hauben / cover	€
13382	38	12	30	22,40
13385	38	13	33	23,60



Tablett mit Haube

tray with cover
bandeja con campana
plateau avec cloche

2-teilig: Tablett aus Edelstahl, hochglanzpoliert + Haube

2 pcs.: stainless steel tray, mirror polished + cover
set de 2: bandeja de acero inoxidable, pulido brillante + campana
set de 2: plateau en acier inox, poli brillant + cloche



	Ø cm	↑ cm	€/ set
00827	27	12,5	13,00



Tablett mit Haube

tray with cover
bandeja con campana
plateau avec cloche

2-teilig: Tablett aus Edelstahl, hochglanzpoliert + Haube

2 pcs.: stainless steel tray, mirror polished + cover
set de 2: bandeja de acero inoxidable, pulido brillante + campana
set de 2: plateau en acier inox, poli brillant + cloche



	cm	↑ cm	€/ set
00828	30 x 15,5	10,5	14,20



Tablett mit Haube „ELEGANCE“

tray with cover
bandeja con campana
plateau avec cloche

2-teilig: Tablett aus Edelstahl + Haube

2 pcs.: stainless steel tray + cover
set de 2: bandeja de acero inoxidable + campana
set de 2: plateau en acier inox + cloche



	cm	↑ cm	€
23642	35 x 19	10	11,40



Tablett mit Haube „ELEGANCE“

tray with cover
bandeja con campana
plateau avec cloche

2-teilig: Tablett aus Edelstahl + Haube

2 pcs.: stainless steel tray + cover
set de 2: bandeja de acero inoxidable + campana
set de 2: plateau en acier inox + cloche



	cm	↑ cm	€
00064	33 x 17	10	8,80
00067	25 x 19	7	9,40

Haube für 00064 / cover for 00064 / campana para 00064 / cloche pour 00064

	€
06401	3,70

Haube für 00067 / cover for 00067 / campana para 00067 / cloche pour 00067

	€
06701	2,80



Tortenplatte

cake plate
bandeja tartas
plat à gâteau

2-teilig: Tablett aus Edelstahl + Haube

2 pcs.: stainless steel tray + cover
set de 2: bandeja de acero inoxidable + campana
set de 2: plateau en acier inox + cloche



	Ø cm	↑ cm		€ / set
00065	30	11	mit 1 Haube / with 1 cover	9,00
00652	30	7 + 11	mit 2 Hauben / with 2 cover	11,60



Tortenplatte „BAROCK“

cake plate
bandeja tartas
plat à gâteau

2-teilig: Tortenplatte mit Barock-Rand + Haube

2 pcs.: cake plate with decor edge „Barock“ + cover
set de 2: porta tartas, borde decor „Barock“ + campana
set de 2: plateau bord décor „Barock“ + cloche



	Ø cm	↑ cm	€ / set
06503	32	10	12,00

Frischhaltehaube / cover / campana / cloche

	Ø cm	↑ cm	€
06510	30	11,5	5,90



Rolltop-Set

rolltop set
set rolltop
set cloche à fromage



2-teilig: Tablett + Rolltophaube glasklar, rutschfeste Haubenfixierung, klappbar

2 pcs.: tray + rolltop cover, cover non-slip fixed, mountable
set de 2: bandeja + campana abatible fijación antideslizante, montable
set de 2: plateau + cloche abattante, fixation antidérapants, montable

	Ø cm	↑ cm	€/ set
09080	38	24	39,00
09099	50	28	84,00



Rolltop-Set, 3-teilig

rolltop set, 3 pcs.
rolltop, set de 3
rolltop, set de 3



1 Edusstahltablett Ø 38 cm + 1 Naturschieferplatte Ø 33 cm + 1 Rolltophaube Ø 38 cm

1 stainless tray Ø 38 cm + 1 natural slate tray Ø 33 cm + 1 rolltop cover Ø 38 cm
1 bandeja de acero inoxidable Ø 38 cm + 1 bandeja de pizarra natural Ø 33 cm + 1 tapa abatible Ø 38 cm
1 plat inox Ø 38 cm + 1 plat ardoise naturelle Ø 33 cm + 1 cloche Ø 38 cm

	Ø cm	↑ cm	€/ set
01000	38	24	48,50



Kaviarkühler

caviar cooler
enfriador de caviar
rafraîchisseur de caviar



4-teilig: 1 Edusstahlschale, 1 Halter, 1 Glasschale, 1 Edusstahldeckel

4 pcs.: 1 stainless steel bowl, 1 holder, 1 glass bowl Ø 10 cm, 1 stainless steel cover
set de 4: 1 bol de acero inoxidable, 1 soporte, 1 bol de vidrio Ø 10 cm, 1 tapa de acero inoxidable
set de 4: 1 bol en acier inox, 1 support, 1 bol en verre Ø 10 cm, 1 couvercle en acier inox

	Ø cm	↑ cm	€
01699	18	12	56,00



Serviertöpfchen „MUMBAI“

small serving pot
olla pequeña de servir
marmite petite de servir



gehämmerte Oberfläche

hammered surface
superficie martillada
surface martelée

	Ø cm	↑ cm	ltr.	Griff / handle cm	€
40186	9,5	5,5	0,30	2,5	8,60
40187	13,5	5,0	0,55	3,0	9,80
40188	15,5	5,0	0,75	3,0	11,60



Tablett mit Haube

tray with cover
bandeja con campana
plateau avec cloche

2 teilig: Tablett aus geöltem Buchenholz (Ø 18,5 cm, H: 2,5 cm) + Glas-Haube (Ø 16 cm, H: 22,5 cm)

2 pcs.: tray of oiled beech wood + glass cover
set de 2: bandeja de madera haya + campana de cristal
set de 2 : plateau en bois de hêtre + cloche en verre



	Ø cm	↑ cm	€ / set
00830	18,5	24	36,00



Tablett mit Haube, 2-teilig

tray with cover, 2 pcs.
bandeja con campana, set de 2
plateau avec cloche, set de 2

Tablett aus Bambus, ölprägniert + Haube

bamboo tray, oil-impregnated + cover
bandeja de bambú, impregnada de aceite + campana
plateau en bambou, imprégné d'huile + cloche



	Ø cm	↑ cm	€ / set
00825	25	13,5	11,00



Tablett mit Haube, 2-teilig

tray with cover, 2 pcs.
bandeja con campana, set de 2
plateau avec cloche, set de 2

Tablett aus Bambus, ölprägniert + Haube

bamboo tray, oil-impregnated + cover
bandeja de bambú, impregnada de aceite + campana
plateau en bambou, imprégné d'huile + cloche



	cm	↑ cm	€ / set
00826	28 x 14	11,5	9,80



Tablett mit Haube, 2 teilig

tray with cover, 2 pcs.
bandeja con campana, set de 2
plateau avec cloche, set de 2

Tablett aus Bambus, ölprägniert + Haube

bamboo tray, oil-impregnated + cover
bandeja de bambú, impregnada de aceite + campana
plateau en bambou, imprégné d'huile + cloche



	Ø cm	↑ cm	€ / set
00822	20,5	10	8,60

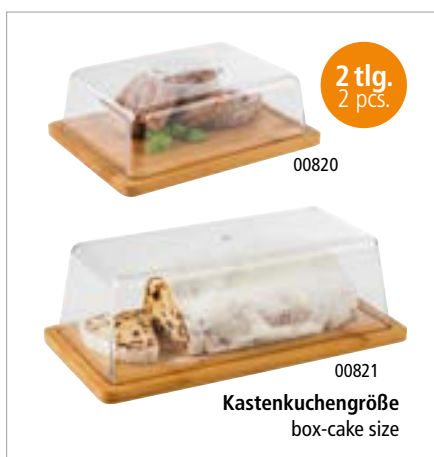

Tablett mit Haube, 2 teilig

tray with cover, 2 pcs.
bandeja con campana, set de 2
plateau avec cloche, set de 2

Tablett aus Bambus, ölprägniert + Haube

bamboo tray, oil-impregnated + cover
bandeja de bambú, impregnada de aceite + campana
plateau en bambou, imprégné d'huile + cloche



	cm	↑ cm	€ / set
00820	24 x 18,5	8	7,40
00821	32 x 16,5	11	9,80



00393 oder / or 00396
96 x

00391 oder / or 00398
96 x

00392 oder / or 00399
96 x

00394 oder / or 00395
96 x

Warenträger

display | expositor | présentoir

für Partyplatten

- platzsparende flexible Präsentation durch geringe Abmessungen
- als Zweitplatzierung für Ihre zusätzlichen Umsätze
- in weiß lieferbar

para bandejas party

- presentación flexible que ahorra espacio gracias a sus pequeñas dimensiones
- como colocación secundaria para sus ventas adicionales
- disponible en blanco

for party trays

- space-saving flexible presentation due to small dimensions
- as secondary placement for your additional sales
- available in white

pour les plateaux party

- présentation flexible peu encombrante grâce à ses dimensions réduites
- comme deuxième emplacement pour vos ventes supplémentaires
- disponible en blanc

	cm	↑ cm
00397	55 x 65	190



Ø 35 cm

00396 round

00398 oval

GN 1/1 00395

Partyplatte „CLASSIC“

partytray
bandeja party
plateau party

Rand eingerollt

rolled edge
borde enrollado
bord enroulé



	cm	↑ cm	GN		VE / unit	€ / pc.
00396	Ø 35	1,5	-	round	48	5,00
00398	46,0 x 34,0	1,5	-	oval	48	5,00
00399	41,0 x 31,0	1,5	-		48	5,00
00389	35,4 x 32,5	1,5	2/3		48	4,80
00395	53,0 x 32,5	1,5	1/1		36	7,90



Ø 35 cm

00393 round

00391 oval

00392

Partyplatte „CLASSIC“

partytray
bandeja party
plateau party

Rand eingerollt

rolled edge
borde enrollado
bord enroulé



	cm	↑ cm		VE / unit	€ / pc.
00393	Ø 35	1,5	round	48	5,00
00391	46 x 34	1,5	oval	48	5,00

	cm	↑ cm	GN	VE / unit	€ / pc.
00392	41 x 31	1,5	-	48	5,00
00394	53 x 32,5	1,5	1/1	48	7,90





Serviertablett „KAFFEEHAUS“

tray
bandeja
plateau

hochglanzpoliert, stabiler Rand eingerollt
mirror polished, stable edge rolled in
pulido brillante, borde estable enrollado
poli brillant, bord stable enroulé



	cm	↑ cm	€
30148	Ø 27	1,5	6,10
30149	30 x 15,5	1,5	7,00

passende Hauben / cover / campana / cloche



	cm	↑ cm	suitable for	€
11055	Ø 23	12,0	30148	5,70
11056	26 x 12	10,0	30149	7,90



Servierbeispiel
presentation example



Serviertablett „KAFFEEHAUS“

tray
bandeja
plateau

matt poliert, oval, Rand eingerollt
matt polished, oval, rolled edge
pulido mate, oval, borde enrollado
poli mat, ovale, bord enroulé



	cm	↑ cm	€
30111	20,0 x 14,5	0,5	für Zucker und Sahne / for sugar and cream 4,70
30112	26,5 x 19,5	0,5	für eine Tasse / for one cup 7,00
30113	29,0 x 22,0	0,5	für zwei Tassen / for two cups 7,50

Antik-Edelstahl-Look

stainless steel antique look
acero estilo antiguo
acier style antique



	cm	↑ cm	€
30140	20,0 x 14,5	1,0	für Zucker und Sahne / for sugar and cream 5,00
30141	26,5 x 19,5	1,0	für eine Tasse / for one cup 7,60
30142	29,0 x 22,0	1,0	für zwei Tassen / for two cups 9,80



Serviertablett „KAFFEEHAUS“

tray
bandeja
plateau

hochglanzpoliert, oval, Rand eingerollt
mirror polished, oval, rolled edge
pulido brillante, ovalado, borde enrollado
poli brillant, ovale, bord enroulé



	cm	↑ cm	€
30115	20,0 x 14,5	0,5	für Zucker und Sahne / for sugar and cream 4,70 para azúcar y crema / pour le sucre et la crème
30116	26,5 x 19,5	0,5	für eine Tasse / for one cup 7,00 para una taza / pour une tasse
30117	29,0 x 22,0	0,5	für zwei Tassen / for two cups 7,50 para dos tazas / pour deux tasses



Serviertablett „KAFFEEHAUS“

tray
bandeja
plateau

matt poliert, Rand eingerollt
matt polished, rolled edge
pulido mate, borde enrollado
poli mat, bord enroulé



	cm	↑ cm	€
30118	21,5 x 13	1,5	7,90
30119	23,0 x 23	1,5	10,90
30120	20,0 x 11	1,5	8,00
30121	29,0 x 20	1,5	16,40



Serviertablett „KAFFEEHAUS“

tray
bandeja
plateau

matt poliert, oval
matt polished, oval
pulido mate, oval
poli mat, ovale



	cm	↑ cm	€
30126	25,5 x 19,5	2	6,40



Serviertablett „KAFFEEHAUS“

tray
bandeja
plateau



	cm	↑ cm	Farbe / Colour	€
84251	26,0 x 20,0	1,5	■	4,80
84253	28,5 x 21,5	1,5	■	5,40



Serviertablett „KAFFEEHAUS“

tray
bandeja
plateau

Innenfläche ziseliert, Rand eingerollt
chiselled inner surface, rolled edge
superficie interior cincelada, borde enrollado
surface intérieure ciselée, bord enroulé



	cm	↑ cm	VE / unit	€ / pc.
30114	30 x 22	1,0	48	3,00



Tablett „VINTAGE“

tray
bandeja
plateau

Antik-Edelstahl-Look

stainless steel antique look
acero estilo antiguo
acier style antique



	cm	↑ cm	€
30130	26,0 x 13,5	1,5	8,00
30131	34,0 x 18,0	1,5	13,20
30132	38,0 x 26,5	1,5	21,00
30133	25,5 x 16,0	3,0	16,00
30134	32,5 x 21,5	2,0	15,00

passende Schälchen / fitting bowls / cuencos adecuados / bols appropriés



	Ø cm	↑ cm	ltr.	€
40655	7,5	5,5	0,17	3,20
40656	7,5	10,0	0,35	4,00

Wachspapier / greaseproof paper squares / papel alimenticio / papier alimentaire

	cm	pcs.		€ / set
40670	42 x 25	500	Motiv: Zeitung	59,00



S. 236
page 236



Servierbeispiel
presentation example



Tablett „TREND“

baking sheet
bandeja
plateau

ein Backblech wird zum Serviertablett

a baking sheet which becomes a serving tray
una bandeja de hornear que se convierte en una bandeja de servir
un moule qui devient un plateau de service



	cm	↑ cm	€
13380	32 x 21,5	2	9,90

NATURAL SLATE



EXTRA STRONG
6-9 mm thickness

Naturschiefer speichert auf natürliche Weise Kälte besonders gut. Die Kanten der Platten sind gebrochen und nicht gesägt.

Natural slate stores cold particularly well in a natural way. The edges of the panels are broken and not sawn.

La pizarra natural almacena el frío especialmente bien de forma natural. Los bordes de las bandejas están rotos y no aserrados.

L'ardoise naturelle stocke particulièrement bien le froid de manière naturelle. Les bords des plateaux sont brisés et non sciés.

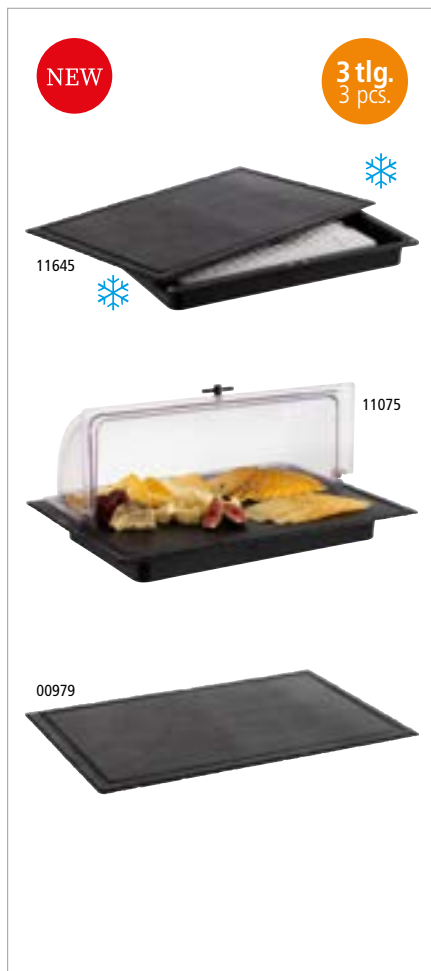

Kühlbox „SLATE“ refrigerated buffet display expositor buffet frío plateau buffet froid

3-teilig, bestehend aus: 1 Basis aus schwarzem Polystyrol,
1 Naturschieferplatte, 1 Kühlakku (ohne Haube)
3 pcs., set consists of: 1 base made of black polystyrene, 1 natural slate tray, 1 cooler (without cover)

set de 3 compuesto por: 1 soporte de poliestireno negro, 1 bandeja de pizarra natural, 1 acumulador de frío (sin campana)

set de 3 composé de: 1 support en polystyrène noir, 1 plateau en ardoise naturelle, 1 accumulateur de froid (sans couvercle)



	cm	↑ cm	€
11645	58 x 38	6,5	80,00

Naturschieferplatte / natural slate tray / bandeja de pizarra natural / plateau ardoise naturelle

	cm	* mm	€
00979 <small>NEW</small>	58 x 38	6 - 9	19,00

Kühlakku / cooler / acumulador de frío / accumulateur de froid

	cm	↑ cm	€
10782	41 x 21	2,5	16,00

Basis / base / soporte / support

	cm	↑ cm	€
11619 <small>NEW</small>	52 x 32	5,5	49,00

GN Rolltophaube mit schwarzem Griff / GN rolltop cover with black handle / GN campana rolltop con mango negro / GN cloche rolltop avec poignée noire

	cm	↑ cm	GN	€
11075 <small>NEW</small>	53 x 32,5	19	1/1	62,00



GN 1/1 Naturschieferplatte „HOCHSTAPLER“ GN 1/1 natural slate tray GN 1/1 bandeja de pizarra natural GN 1/1 plat ardoise naturelle



	cm	↑ cm	* mm	€
00966	53 x 32,5	6	6 - 9	35,80



Griffe verchromt, 4 cm Nutzhöhe
chrome plate handles, 4 cm distance

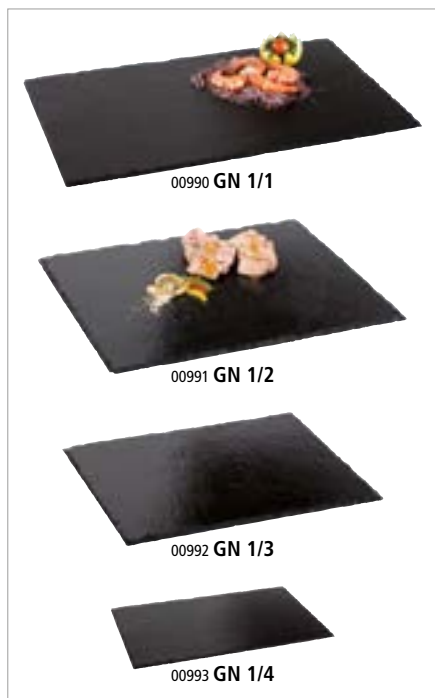

GN Naturschieferplatten
 GN natural slate tray
 GN bandeja de pizarra natural
 GN plat ardoise naturelle



	cm	✱ mm	GN	€
00990	53,0 x 32,5	6 - 9	1/1	15,80
00991	32,5 x 26,5	6 - 9	1/2	8,80
00992	32,5 x 17,6	6 - 9	1/3	5,40
00993	26,5 x 16,2	6 - 9	1/4	5,00
00973	53,0 x 16,2	6 - 9	2/4	6,50



Naturschieferplatte
 natural slate tray
 bandeja de pizarra natural
 plat ardoise naturelle



	cm	✱ mm		€
00996	45 x 30	6 - 9		12,60
00979	58 x 38	6 - 9	mit Safrille / with juice groove	19,00



Naturschieferplatte
 natural slate tray
 bandeja de pizarra natural
 plat ardoise naturelle



	cm	✱ mm		€
00994	25 x 25	6 - 9		6,40
00995	30 x 30	6 - 9		9,50

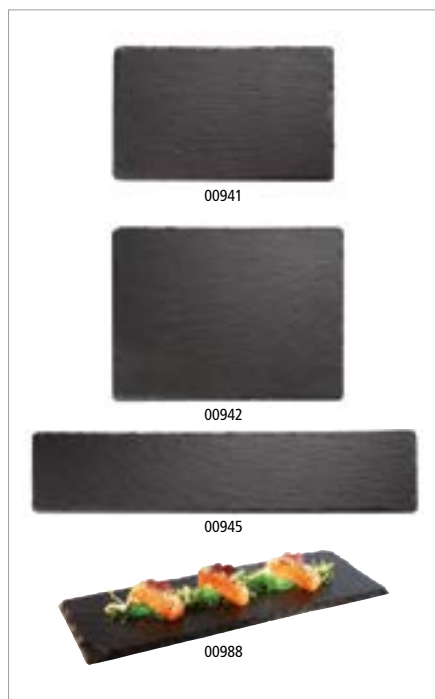

Naturschieferplatte
 natural slate
 bandeja de pizarra natural
 plateau ardoise naturelle



	cm	✱ mm		€
00941	24,0 x 15,0	6 - 9		4,20
00942	26,5 x 20,5	6 - 9		6,40
00943	47,0 x 10,0	6 - 9		6,40
00988	30,0 x 12,0	6 - 9		4,30

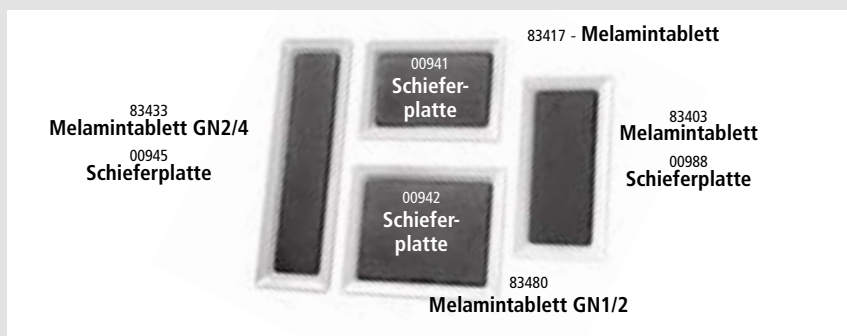



Naturschieferplatte

natural slate tray
bandeja pizarra natural
plat ardoise naturelle

mit Safrille, Ø 9,5 cm Aussparung

with juice groove, with hole Ø 9,5 cm

con ranura para líquidos, con agujero Ø 9,5 cm

avec rigole, avec trou Ø 9,5 cm



	cm	✱ mm	€
00947	33 x 24	6 - 9	11,00

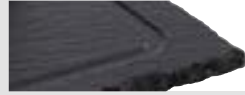

mit Safrille
with juice groove

Wachspapier / greaseproof paper squares / papel alimenticio / papier alimentaire

	cm	pcs.	Motiv: Zeitung	€
40670	42 x 25	500		59,00

Servier-Frittierkorb / fry baskets / cestitas para el servicio mesa / paniers pour le service sur table

	Ø cm	↑ cm	Griff / handle cm	Farbe / Colour	€
40601	9	8,5	9,0	stainless steel	11,20
40603	9	8,5	9,0	gold	13,60
40625 NEW	9	8,5	9,0	black mat	13,60



Naturschieferplatte

natural slate tray
bandeja pizarra natural
plat ardoise naturelle

mit 3 x Ø 6 cm Aussparung

with 3 holes, Ø 6 cm

con 3 agujeros, Ø 6 cm

avec 3 trous, Ø 6 cm



	cm	✱ mm	€
00987	28 x 10	6 - 9	5,80



Naturschieferplatte

natural slate tray
bandeja pizarra natural
plat ardoise naturelle

mit Ø 6 cm Aussparung

with hole Ø 6 cm

con agujero Ø 6 cm

avec trou Ø 6,0 cm



	cm	✱ mm	€
00986	25 x 12	6 - 9	4,20



Naturschieferplatte / Untersetzer

natural slate tray
bandeja de pizarra natural
plateau ardoise naturelle

mit 2 x Ø 6 cm Aussparung

with 2 holes Ø 6 cm

con 2 agujeros Ø 6 cm

avec 2 trous Ø 6 cm



	cm	✱ mm	€
00971	15 x 8	6 - 9	3,40

**Naturschieferplatte „STARTER“**

natural slate tray
bandeja de pizarra natural
plat ardoise naturelle



	cm	mm	€
00937	20 x 10	6 - 9	3,10



00969

Naturschieferplatte

natural slate tray
bandeja de pizarra natural
plat ardoise naturelle



	Ø cm	mm	€
00968	22	6 - 9	5,20
00969	28	6 - 9	7,30
00998	33	6 - 9	8,70
00999	38	6 - 9	12,80



Präsentationsmöglichkeit
presentation example

**Tortenplatte / Servierplatte**

cake stand
soporte para pastel
présentoir à gâteaux

drehbar
rotatable
giratorio
rotatif



	Ø cm	↑ cm	mm	€
00975	32	2,5	6 - 9	18,40



drehbare Servierplatte
rotatable cake stand



3 tlg.
3 pcs.

Rolltop-Set

rolltop set
rolltop set
rolltop set

3-teilig: • 1 Edelstahltablett Ø 38 cm
• 1 Naturschieferplatte Ø 33 cm
• 1 Rolltophaube Ø 38 cm

3 pcs.: • 1 stainless steel tray Ø 38 cm
• 1 natural slate tray Ø 33 cm
• 1 rolltop cover Ø 38 cm

set de 3: • 1 bandeja de acero inoxidable Ø 38 cm
• 1 bandeja de pizarra natural Ø 33 cm
• 1 campana abatible Ø 38 cm

set de 3: • 1 plateau en acier inox 38 cm
• 1 plateau ardoise naturelle 33 cm
• 1 cloche basculante 38 cm



	Ø cm	↑ cm	€ / set
01000	38	24	48,50

SERVING BOARDS | NATURAL SLATE



3-stufige Etagère

3-tier tray
bandeja con tres alturas
étagère carré 3 hauteurs

Naturschiefer, Akazienholz

natural slate tray, wood akazie

bandeja de pizarra natural, madera de acacia

plateau ardoise naturelle, bois d'acacia



	Ø cm	↑ cm	✱ mm	€
00960	30 / 25 / 20	34	6 - 9	30,00

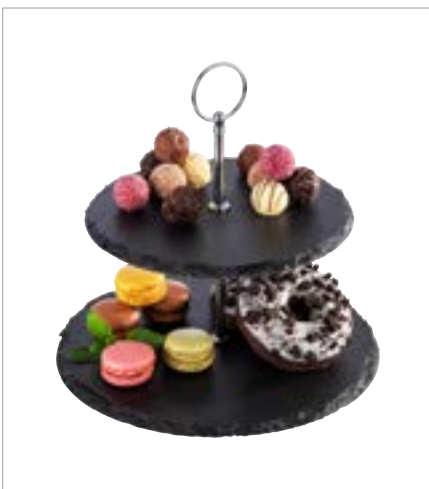

2-stufige Etagère

2-tier tray
bandeja dos alturas
étagère carré 2 hauteurs

Naturschiefer

natural slate tray

bandeja de pizarra natural

plateau ardoise naturelle



	Ø cm	↑ cm	✱ mm	€
00989	25 / 20	24	6 - 9	15,30



Naturschieferplatte

natural slate tray
bandeja de pizarra natural
plateau ardoise naturelle

2-teilig: Naturschieferplatte mit Glashaube

2 pcs.: natural slate tray with glass cover

set de 2: bandeja de pizarra natural con tapa de cristal

set de 2: plateau ardoise naturelle avec cloche en verre

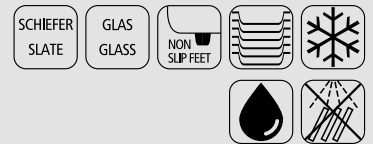

	Ø cm	↑ cm	✱ mm	€ / set
00984	10,5	8	6 - 9	8,50



Naturschieferplatten, 4er Set

natural slate tray, 4 pcs.
bandeja pizarra natural, set de 4
plateau ardoise naturelle, set de 4



	cm	✱ mm	pcs.	€ / set
00997	10 x 10	6 - 9	4	8,50



NEW

SQUARE



NEW



00758 GN 1/1

11075

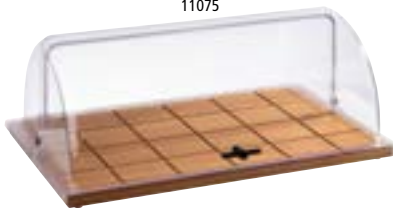

GN 1/1 Buffetbrett „SQUARE“

GN 1/1 buffet board
GN 1/1 tabla de buffet
GN 1/1 planche de buffet

aus geöltem Eichenholz
made of oiled oak wood
de madera de roble aceitada
en bois de chêne huilé



	cm	↑ cm	GN	€
00758	53,0 x 32,5	2,5	1/1	46,00

passende Haube / suitable cover / campana adecuada / cloche appropriée

	cm	↑ cm	GN	€
11075	53,0 x 32,5	19	1/1	62,00



Haube fixiert sich auf dem Brett, rutschfest
cover fixes itself on the board, non-slip

NEW



00759 GN 1/2

11073



GN 1/2 Buffetbrett „SQUARE“

GN 1/2 buffet board
GN 1/2 tabla de buffet
GN 1/2 planche de buffet

aus geöltem Eichenholz
made of oiled oak wood
de madera de roble aceitada
en bois de chêne huilé



	cm	↑ cm	GN	€
00759	32,5 x 26,5	2,5	1/2	30,00

passende Haube / suitable cover / campana adecuada / cloche appropriée

	cm	↑ cm	GN	€
11073	33 x 28	17	1/2	29,00



Haube fixiert sich auf dem Brett, rutschfest
cover fixes itself on the board, non-slip



GN 2/4 Buffetbrett „SQUARE“

GN 2/4 buffet board
GN 2/4 tabla de buffet
GN 2/4 planche de buffet

aus geöltem Eichenholz
made of oiled oak wood
de madera de roble aceitada
en bois de chêne huilé



	cm	↑ cm	GN	€
00760	53,0 x 16,2	2,5	2/4	30,00



Präsentationsmöglichkeit
presentation example

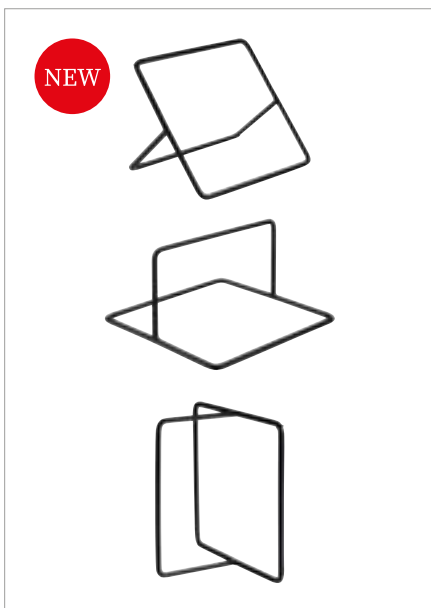

Buffetständer „SQUARE“

buffet stand
soporte para buffet
présentoir buffet

Metall, mit schwarzer Antirutschbeschichtung
metal, with black anti-slide coating
metal, con revestimiento antideslizante negro
métal, avec revêtement antidérapant noir



	cm	↑ cm	€
33305	12 x 12	7	7,00



Präsentationsmöglichkeit | presentation example



Buffetbrett

buffet board
tabla de buffet
planche de buffet

für Karaffen, mit 3 Einsätzen Ø 11 cm aus Kunstleder, aus geöltem Eichenholz
for carafes, with 3 leatherette inserts Ø 11 cm, made of oiled oak wood
para jarras, con 3 inserciones de imitación de cuero Ø 11 cm, de madera de roble aceitada
pour pichets, avec 3 inserts en cuir synthétique Ø 11 cm, en bois de chêne huilé



	cm	↑ cm	Farbe / Colour	€
11705	47 x 19	2	natural oak	82,00
11706	47 x 19	2	dark oak	82,00

passende Karaffe / suitable carafe / jarra a juego / pichet approprié

	Ø cm	↑ cm	ltr.	€
10690	9,5	31	1,0	15,90

6 Einsätze aus Kunstleder / 6 leatherette inserts / 6 inserciones de imitación de cuero / 6 inserts en cuir synthétique

	Ø cm	Farbe / Colour	pcs.	€ / set
35716	11	anthracite	6	17,40



Kunstledereinsatz herausnehmbar
removable leatherette insert

SERVING BOARDS



NEW

**Servierbrett**

serving board
tabla de servir
planche de service

aus geöltem Akazienholz

made of oiled acacia wood
de madera de acacia aceitada
en bois d'acacia huilé



	cm	↑ cm	€
00793	25 x 17	1,5	12,00

NEW

**Servierbrett**

serving board
tabla de servir
planche de service

aus geöltem Akazienholz

made of oiled acacia wood
de madera de acacia aceitada
en bois d'acacia huilé



	cm	↑ cm	€
00792	37 x 8	2	10,00



Präsentationsmöglichkeit
presentation example

NEW

**Servierschale**

serving bowl
cuenca de servir
bol de service

aus geöltem Akazienholz

made of oiled acacia wood
de madera de acacia aceitada
en bois d'acacia huilé



	cm	↑ cm	€
00790	16,5 x 9	2	10,00
00791	23,5 x 13	2	12,00

SERVING BOARDS | WOOD



Servierbrett
serving board
tabla de servir
planche de service



2-teilig: 1 Holzbrett aus Akazienholz + 1 Naturschieferplatte

2 pcs.: 1 wood board made of acacia wood + 1 natural slate tray
set de 2: 1 tabla de madera de acacia + 1 pizarra natural
set de 2: 1 planche en bois d'acacia + 1 ardoise naturelle

	cm	↑ cm	€/ set
00814	28 x 17,5	2	16,00



Servierbrett
serving board
tabla de servir
planche de service



2-teilig: 1 Holzbrett aus Akazienholz + 1 Naturschieferplatte

2 pcs.: 1 wood board made of acacia wood + 1 natural slate tray
set de 2: 1 tabla de madera de acacia + 1 pizarra natural
set de 2: 1 planche en bois d'acacia + 1 ardoise naturelle

	cm	↑ cm	Griff / handle cm	€/ set
00810	26 x 18	2	8	15,00
00811	33 x 20	2	8	18,40
00812	40 x 15	2	5	23,40
00813	43 x 12	2	12	18,40

Präsentationsmöglichkeit
presentation example



mit Hängeloch Ø 2 cm / with a handle-hole Ø 2 cm



Servierbrett
serving board
tabla de servir
planche de service



Servierbrett aus geöltem Akazienholz

serving board made of oiled acacia wood
tabla de servir de madera de acacia aceitada
planche en bois avec plateau en bois d'acacia huilé

	cm	↑ cm	€
00897	30 x 15	2	13,60
00898	30 x 18	2	16,00
00899	35 x 25	2	22,40

**Servierbrett „SHARING“**

serving board
tabla de servir
planche de service

**Servierbrett aus geöltem Akazienholz**

serving board made of oiled acacia wood
tabla de servir de madera de acacia aceitada
planche en bois d'acacia huilé

	cm	↑ cm	Griff / handle cm	€
00887	51,5 x 18	1,5	8,5	33,00

**Servierbrett „AKAZIE-SCHIEFER“**

serving board
tabla de servir
planche de service

**raffiniertes, rustikales Servierbrett aus Akazienholz, ausgestattet mit einem Naturschieferstreifen zur Kennzeichnung**

wood with slate, markable
madera con pizarra, se puede marcar
bois avec ardoise, on peut mettre une inscription

	cm	↑ cm	Griff / handle cm	€
00867	30,5 x 13	1,5	10	18,00
00868	36,5 x 15	1,5	12	23,00
00869	42,0 x 18	1,5	14	26,00

**Servierbrett „OLIVE“**

serving board
tabla de servir en madera de olivo
planche de service en bois d'olivier

**aus geöltem Olivenholz, mit 19 mm Aufhäng Bohrung, naturbedingte Abweichung in Form, Maserung und Größe**

oiled olive wood, natural deviation in shape, grain and size
de madera de olivo aceitada, diferencias naturales posibles en forma, grano y tamaño

en bois d'olivier huilé, éventuelles différences naturelles de forme, de grain et de taille

	cm	↑ cm	Griff / handle cm	€
00870	25 x 17,0	1,5		32,00
00871	30 x 20,5	2,0		52,00
00873	40 x 15,0	1,5	11	56,00
00874	44 x 20,0	2,0	12	72,00
00875	19 x 12,5	1,5	6	23,00
00876	25 x 16,0	1,5	8	35,00
00877	31 x 20,0	1,5	9	52,00



Servierbrett „OLIVE“

serving board
tabla de servir
planche de service



aus geöltem Olivenholz, naturbedingte Abweichung in Form, Maserung und Größe

oiled olive wood, natural deviation in shape, grain and size

de madera de olivo aceitada, diferencias naturales posibles en forma, grano y tamaño

en bois d'olivier huilé, éventuelles différences naturelles de forme, de grain et de taille

	cm	↑ cm	€
00905	25,5 x 16,5	1,5	12,00
00906	35,0 x 20,5	1,5	22,00



Servier- und Tortenplatte

cake stand
porta pasteles
présentoir à gâteaux



Eichenholz geölt, mit Safrille

oak wood oiled, with juice groove

madera de roble aceitada, con ranura para líquidos

bois de chêne huilé, avec rigole

	Ø cm	↑ cm	€
00818	32	2,0	30,00



Präsentationsmöglichkeit
presentation example

passende Hauben / cover / campana / cloche



	Ø cm	↑ cm	€
06510	30	11,5	5,90
06512	30	11,5	8,20
06520	30	22	40,00



Servierbrett „OAK“

serving board
tabla de servir
planche de service



aus geöltem Eichenholz, Safrille, Ø 9,5 cm Aussparung

made of oiled oak, with juice groove, with hole Ø 9.5 cm

de madera de roble aceitada, con ranura para líquidos, con agujero Ø 9,5 cm

en bois chêne huilé, avec rigole, avec trou Ø 9,5 cm

	cm	↑ cm	€
00808	37 x 25	2	29,00



mit Safrille
with juice groove

SERVING BOARD



Ø 6 cm



82316

beidseitig nutzbar
double-sided usable

Servierbrett

serving board
tabla de servir
planche de service

aus geöltem Eichenholz, mit 8 Vertiefungen Ø 6 cm

made of oiled oak wood, with 8 notches Ø 6 cm

de madera de roble aceitada con 8 ranuras Ø 6 cm

en bois de chêne huilé avec 8 encoches Ø 6 cm



	cm	↑ cm	€
00809	100 x 14	1,5	42,00

Präsentationsmöglichkeit
presentation example



40636
Henkelbecher
beaker

mit Hängeloch Ø 2 cm / with a handle-hole Ø 2 cm



mit Hängeloch Ø 1,5 cm
with a handle-hole Ø 1,5 cm

Präsentationsmöglichkeit
presentation example

Servierbrett

serving board
tabla de servir
planche de service

aus geöltem Buchenholz mit Daumenmulde auf einer Seite

made of oiled beech wood with thumb recess on one side

de madera de haya aceitada con hueco para el pulgar en un lado

en bois de hêtre huilé avec encoche pour le pouce sur un côté



	cm	↑ cm	€
00817	60 x 19,5	2	29,00



Eiche, das widerstandsfähigste europäische Holz, ist seit jeher Ausdruck von Qualität, Kraft und Energie.
Eichen werden uralt und riesengroß, sind unvergleichlich stark und standfest.

Oak, the most resistant European wood, has always been an expression of quality, strength and energy.
Oaks grow to be ancient and huge, are incomparably strong and stable.

El roble, la madera europea más resistente, siempre ha sido una expresión de calidad, fuerza y energía.
Los robles se vuelven antiguos y enormes, son incomparablemente fuertes y estables.

Le chêne, le bois européen le plus résistant, est depuis toujours l'expression de la qualité, de la force et de l'énergie.
Les chênes deviennent très vieux et gigantesques, ils sont incomparablement forts et stables.



Servierbrett „SIMPLY WOOD“

servicing board
tabla de servir
planche de service



Eichenholz geölt, mit Aufhängeloch Ø 1,5 cm, mit Lederband

oak wood oiled, with handle hole Ø 1,5 cm, with leather strap
madera de roble aceitada, con agujero para colgar Ø 1,5 cm, con correa de cuero
bois de chêne huilé, avec trou de suspension Ø 1,5 cm, avec ruban en cuir

	cm	↑ cm	→ Griff / handle	€
00750	20 x 20	2	8	25,00
00751	27 x 17	2	8	29,00
00752	32 x 22	2	8	39,00



mit Lederband
with leather strap

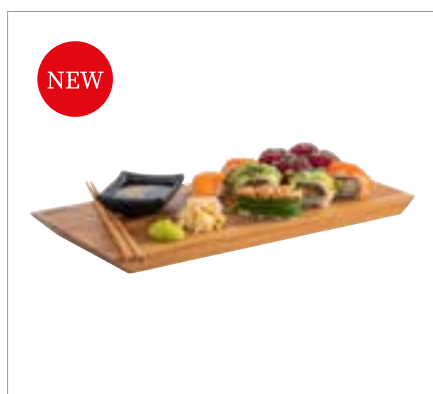

Tablett / Sushiboard „SIMPLY WOOD“

tray / sushiboard
bandeja para sushi
plateau sushi

aus geöltem Eichenholz
made of oiled oak wood
de madera de roble aceitada
en bois de chêne huilé



	cm	↑ cm	€
00753	35 x 17	2	22,00

**GN 1/3 Servierbrett „SIMPLY WOOD“**

GN 1/3 serving board
GN 1/3 tabla de servir
GN 1/3 planche de service



Eichenholz geölt, mit Vertiefung Ø 4 cm, mit Safrinne

oak wood oiled, with notch Ø 4 cm, with juice groove
madera de roble aceitada, con ranura Ø 4 cm, con ranura para líquidos
bois de chêne huilé, mit avec encoche Ø 4 cm, avec rigole

	cm	↑ cm	GN	€
00754	32,5 x 17,6	2	1/3	22,00

**Servierbrett**

serving board
tabla de servir
planche de service



Eichenholz, geölt, 2 Vertiefungen Ø 4,5 cm, 1 Vertiefung Ø 3 cm, mit 2 Griffmulden

oak wood oiled, 2 notches Ø 4,5 cm, 1 notch Ø 3 cm, with 2 recessed handles
madera de roble aceitada, 2 ranuras Ø 4,5 cm, 1 ranura Ø 3 cm, con 2 asas empotradas
bois de chêne huilé, 2 encoches Ø 4,5 cm, 1 encoche Ø 3 cm, avec 2 poignées encastrées

	cm	↑ cm	€
00835	15 x 9	1,5	10,00

passende Gläser / fitting glasses / tarros de vidrio adecuados / verrines appropriées

	Ø cm	↑ cm	ltr.	pcs	€ / set
82350	5,5	6	0,075	12	22,70
82351	5,5	9	0,145	12	24,80

**Servierbrett „PIZZA“**

serving board
tabla de servir
planche de service



Eichenholz geölt, mit Safrinne, mit 2 Griffmulden

oak wood oiled, with juice groove, with 2 recessed handles
madera de roble aceitada, con ranura para líquidos, con 2 asas empotradas
bois de chêne huilé, avec rainure à jus, avec 2 poignées encastrées

	Ø cm	↑ cm	€
00755	24	2	22,00
00756	29	2	26,00
00757	34	2	30,00



mit 2 Griffmulden an der Unterseite
with 2 recessed handles on the bottom

**Serviervablett**

serving tray
bandeja para servir
plateau de service



aus geöltem Eichenholz, mit 2 Griffmulden

made of oiled oak wood, with 2 recessed handles
de madera de roble aceitada, con 2 asas empotradas
en bois de chêne huilé, avec 2 poignées encastrées

	cm	↑ cm	€
00761	45 x 35	6	44,00

SERVING BOARDS | WOOD



Servierbrett „GENUSSPALETTE“

serving board
tabla de servir
planche de service

Genusspalette im Kleinformat, Birke
mini serving palett, birch
tabla de servir, formato pequeño, abedul
planche de service, petit format, bouleau



	cm	↑ cm	€
00880	20 x 12	3	10,00
00881	30 x 20	3	12,00
00882	40 x 15	3	14,80



Table Caddy „OLIVE“

table barrel
caddy de mesa
caddy de table

aus geöltem Olivenholz
oiled olive wood
de madera de olivo aceitada
en bois d'olivier huilé



	cm	↑ cm	€
01016	22 x 15	6	21,00
01017	25 x 18	6	29,00



Allzweckstreuer, 12 er Set / shaker, 12 pcs. / dosificador, set de 12 / salières/poivrières set de 12

	cm	↑ cm	ltr.	€ / set
40504	4 x 4	10	0,07	23,40

passende Brottasche / suitable bread basket / panera a juego / corbeilla assortie

	cm	↑ cm	Farbe / Colour	€
30356	12 x 11,5	11,5	■	6,80

passende Mühlen / suitable mills/ molinos de ajuste / moulins assortis

	ø cm	↑ cm	€
40555	6	15,5	33,20
40556	6	15,5	33,20



Wachspapier „SNACKHOLDER“

greaseproof paper squares
papel alimenticio
papier alimentaire



	cm	pcs.	Motiv: Zeitung	€ / set
40670	42 x 25	500	Motiv: Zeitung	59,00



01010

0,15 ltr.



01011

0,25 ltr.



01012

0,50 ltr.

Schale „OLIVE“bowl
cuenco
bol

aus geöltem Olivenholz, naturbedingte Abweichung in Form, Maserung und Größe

oiled olive wood, natural deviation in shape, grain and size

de madera de olivo aceitada, diferencias naturales posibles en forma, grano y tamaño
en bois d'olivier huilé, éventuelles différences naturelles de forme, de grain et de taille

	Ø cm	↑ cm	ltr.	€
01010	10,0	4,0	0,15	10,00
01011	12,5	4,5	0,25	13,80
01012	15,0	6,0	0,50	20,00

3 Größen ineinander
3 sizes in each other

00843

0,05 ltr.



00844

0,10 ltr.

Schale „OLIVE“bowl
cuenco
bol

aus geöltem Olivenholz, naturbedingte Abweichung in Form, Maserung und Größe

oiled olive wood, natural deviation in shape, grain and size

de madera de olivo aceitada, diferencias naturales posibles en forma, grano y tamaño
en bois d'olivier huilé, éventuelles différences naturelles de forme, de grain et de taille

	cm	↑ cm	ltr.	€
00843	12,0 x 7,5	2,5	0,05	7,80
00844	16,5 x 9,5	2,5	0,10	10,00



00907

0,20 ltr.



00908

0,30 ltr.



01023

0,40 ltr.

Schale „OLIVE“bowl
cuenco
bol

aus geöltem Olivenholz, naturbedingte Abweichung in Form, Maserung und Größe

oiled olive wood, natural deviation in shape, grain and size

de madera de olivo aceitada, diferencias naturales posibles en forma, grano y tamaño
en bois d'olivier huilé, éventuelles différences naturelles de forme, de grain et de taille

	cm	↑ cm	ltr.	€
00907	13 x 8	6,5	0,2	6,60
00908	16 x 9	7,0	0,3	10,00
01023	25 x 8,5	7,5	0,4	18,00

SERVING BOARDS | WOOD



Schale „OLIVE“

bowl
cuenco
bol



aus geöltem Olivenholz
oiled olive wood
de madera de olivo aceitada
en bois d'olivier huilé

	cm	↑ cm	litr.	€
01013	7,5 x 7,5	2,5	0,05	5,00
01014	17,5 x 8,5	2,5	0,15	12,40
01015	26,5 x 11,5	5,0	0,60	19,00



Holzbox „TABLE“

woodbox
caja madera
base bois



Akazienholz, 3 Fächer (6,5 x 6,5 cm) / acacia wood, 3 compartments (6,5 x 6,5 cm) / madera de acacia, 3 compartimentos (6,5 x 6,5 cm) / bois d'acacia, 3 compartiments (6,5 x 6,5 cm)

	cm	↑ cm	inner size cm	€
11727	23,5 x 8,5	4,5	6,5 x 6,5 je Fach / each compartment	12,90

Servierbeispiel - Lieferung ohne Gläser
delivery without glasses



Servierbrett „NARROW I“

servicing board
tabla de servir
planche de service



Akazienholz, mit 3 Vertiefungen Ø 4 cm / acacia wood, with 3 notches Ø 4 cm
madera de acacia, con 3 ranuras Ø 4 cm / bois d'acacia, avec 3 encoches Ø 4 cm

	cm	↑ cm	€
00864	22 x 8	1,5	9,90

Servierbeispiel - Lieferung ohne Gläser
delivery without glasses

passende Schälchen / fitting bowls / cuencos adecuados / bols appropriés

	Ø cm	↑ cm	litr.		€
82312	6	5,5	0,08	glass / 12 pcs	27,60
40685	6	3,0	0,05	stainless steel	2,40



Servierbrett „NARROW II“

servicing board
tabla de servir
planche de service



Akazienholz, mit 3 Vertiefungen Ø 6 cm
acacia wood, with 3 notches Ø 6 cm
madera de acacia, con 3 ranuras Ø 6 cm
bois d'acacia, avec 3 encoches Ø 6 cm

	cm	↑ cm	€
00878	31 x 11	2	11,20

Servierbeispiel - Lieferung ohne Schälchen
delivery without bowls

passende Schälchen / fitting bowls / cuencos adecuados / bols appropriés

	Ø cm	↑ cm	litr.		€
40686	8	4,5	0,17	stainless steel	3,60

BUFFET BOARDS „PROFI“



06512

Ø 33 cm

00805



06521

Ø 39 cm

00816

Buffetbrett „PROFI“

buffet board
tabla de buffet
planche de buffet

aus geöltem Eichenholz, Safrinne, mit Antirutschfüßchen

made of oiled oak, with juice groove and non-slip feet

de madera de roble aceitada, con ranura para líquidos y pies antideslizantes

en bois chêne huilé, avec rigole et pieds antidérapants



	Ø cm	↑ cm	€
00805	33	4,5	68,00
00816	39	4,5	110,00

Frischhaltehaube / cover / campana / cloche



	Ø cm	↑ cm	fits to	€
06512	30	11,5	00805	8,20

Frischhaltehaube / cover / campana / cloche



	Ø cm	↑ cm	fits to	€
06519	21	17	00815	30,00
06520	30	22	00805	40,00
06521	36	27	00816	74,00



00807



00806

11016
GN 1/1

00806

Buffetbrett „PROFI“

buffet board
tabla de buffet
planche de buffet

aus geöltem Eichenholz, Safrinne, mit Antirutschfüßchen

made of oiled oak, with juice groove and non-slip feet

de madera de roble aceitada, con ranura para líquidos y pies antideslizantes

en bois chêne huilé, avec rigole et pieds antidérapants



	cm	↑ cm	€
00807	38 x 32,0	4,5	72,00
00806	58 x 37,5	4,5	110,00

Rolltophaube / rolltop cover / campana rolltop / cloche rolltop



	Ø cm	↑ cm	fits to	GN	€
11016	53,0 x 32,5	19	00806	1/1	32,00



CUTTING BOARDS



Brottschneidebrett

cutting board
tabla de cortar
planche à découper

Walnussholz / walnut wood / mader de nogal / bois de noyer



	cm	↑ cm	GN	€
00911	35,4 x 32,5	3,5	2/3	77,00



praktisches Krümelfach
practical crump shelf



praktisches Krümelfach
practical crump shelf

Brottschneidebrett „LETTER“

cutting board
tabla de cortar
planche à découper

Akazienholz / acacia wood / mader de acacia / bois d'acacia



	cm	↑ cm	GN	€
00886	48 x 34	3,5		36,00



praktisches Krümelfach
practical crump shelf



00885

Brottschneidebrett

cutting board
tabla de cortar
planche à découper

Akazienholz / acacia wood / mader de acacia / bois d'acacia



	cm	↑ cm	GN	€
00883	47,5 x 32,0	2		30,00
00884	53,0 x 32,5	2	1/1	31,00
00885	60,0 x 40,0	2		36,00



praktisches Krümelfach
practical crump shelf



Brottschneidebrett

cutting board
tabla de cortar
planche à découper

Rubberwood / rubberwood / mader de caucho / bois d'hévéa



	cm	↑ cm	GN	€
00955	47,5 x 32,0	2		27,00
00956	53,0 x 32,5	2	1/1	29,00
00957	60,0 x 40,0	2		34,00



praktisches Krümelfach
practical crump shelf

**Serviertablett „HAPPY HOUR“**

tray
bandeja
plateau

rutschfeste Oberfläche
non-slip surface
superficie antideslizante
surface antidérapante



	Ø cm	↑ cm	Farbe / Colour	€
00510	32	1,5	■	23,00
00511	38	1,5	■	28,00
00515	43	1,5	■	32,00

**Bierglasträger „NON SLIP“**

beer rack
bandeja para cerveza
porte verre à bière

rutschfeste Oberfläche
non-slip surface
superficie antideslizante
surface antidérapante



	Ø cm	↑ cm	Farbe / Colour	€
00500	36	3,5	■	21,00
00506	28 x 20	1,5	■	9,60

**Tablett „GASTRO“**

tray
bandeja
plateau

rutschfeste Oberfläche
non-slip surface
superficie antideslizante
surface antidérapante



	Ø cm	↑ cm	Farbe / Colour	€
00547	27,5	2	■	7,60
00548	35,5	2	■	9,60
00549	40,5	2	■	11,40

**Tablett „BISTRO“**

tray
bandeja
plateau

rutschfest, mit 2 Griffmulden und Stapelrand
non-slip, two open handles, stackable edge
antideslizante, con 2 asas y borde apilable
antidérapant, avec 2 poignées et bord d'empilage



	Ø cm	↑ cm	Farbe / Colour	€
84045	35,5	4,5	■	26,00

TRAYS



Serviertablett „NON SLIP“

tray non-slip
bandeja
plateau

rutschfeste Oberfläche
non-slip surface
superficie antideslizante
surface antidérapante



	cm	↑ cm	GN	Farbe / Colour	€
00502	53,0 x 32,5	1,5	1/1		25,00
00508	46,0 x 36,0	2,0			22,90



Tablett

tray
bandeja
plateau

rutschfest, Holzdekor-Laminat
non-slip, coated wood
antideslizante, decoración madera láminae
antidérapant, décor bois laminé



	cm	↑ cm		€
00524	43,5 x 31,5	1,5		19,00
00525	52,0 x 39,0	1,5		24,60
00526	60,5 x 42,5	1,5		30,00



Tablett

tray
bandeja
plateau

rutschfest, Mahagonifurnier
non-slip, woodform, mahogany
antideslizante, revestimento de caoba
antidérapant, placage en acajou



	Ø cm	↑ cm		€
00528	31,0	3,5	hoher Rand	19,00
00529	35,5	3,5	hoher Rand	25,00



Tablett

tray
bandeja
plateau

rutschfest, Holzdekor-Laminat
non-slip, coated wood
antideslizante, limando decoracion madera
antidérapant, décor bois stratifié



	cm	↑ cm		€
00521	26 x 20	1		8,60
00522	29 x 21	1		11,20

FAST FOOD TRAYS



Fast Food-Tablett
 snack tray
 bandeja autoservicio y snacks
 plateau self-service et snacks



00535



00536



00537



00538



00534



00539

	cm	↑ cm	GN	Farbe / Colour	€
00530	35 x 27,0	2			3,70
00535	41 x 30,5	2			5,00
00540	45 x 35,5	2			6,20
00552	53 x 32,5	2	1/1		7,60

	cm	↑ cm	GN	Farbe / Colour	€
00531	35 x 27,0	2			3,70
00536	41 x 30,5	2			5,00
00541	45 x 35,5	2			6,20
00553	53 x 32,5	2	1/1		7,60

	cm	↑ cm	GN	Farbe / Colour	€
00532	35 x 27,0	2			3,70
00537	41 x 30,5	2			5,00
00542	45 x 35,5	2			6,20
00554	53 x 32,5	2	1/1		7,60

	cm	↑ cm	GN	Farbe / Colour	€
00533	35 x 27,0	2			3,70
00538	41 x 30,5	2			5,00
00543	45 x 35,5	2			6,20
00555	53 x 32,5	2	1/1		7,60

	cm	↑ cm	GN	Farbe / Colour	€
00534	35 x 27,0	2			3,70

	cm	↑ cm	GN	Farbe / Colour	€
00539	35 x 27,0	2			3,70



stapelbar
 stackable

CAKE STANDS



Servier- und Tortenplatte „CASUAL“ cake plate porta pasteles présentoir à gâteaux



	Ø cm	↑ cm	€
83890	31	8	28,60
83891	31	16	36,00
	cm	↑ cm	€
83892	31 x 31	8	32,00
83893	31 x 31	16	39,00



Servier- und Tortenplatte cake stand porta pasteles présentoir à gâteaux



Rand fixiert die Haube, mit Antirutschfüßchen

carved edge fixes the cover, with non-slip feet

ranura para fijar bien la campana, con pies antideslizantes

bord rainuré pour maintenir ferme la cloche, avec pieds antidérapants



	Ø cm	↑ cm	Farbe / Colour	fits to cover	€
00468	31	3,5	White	06520	18,40
00469	31	3,5	Black	06520	18,40



Servier- und Tortenplatte cake stand porta pasteles présentoir à gâteaux



Eichenholz geölt, mit Safrin

oak wood oiled, with juice groove

madera de roble aceitada, con ranura para líquidos

bois de chêne huilé, avec rigole

	Ø cm	↑ cm	€
00818	32	2,0	30,00

passende Hauben / suitable for covers / campanas adecuadas / cloches appropriées

	Ø cm	↑ cm	€
06520	30	22	40,00
06510	30	11,5	5,90



Servier- und Tortenplatte „ACACIA“

cake stand
porta pasteles
présentoir à gâteaux

Akazienholz geölt, möbelschonende Unterseite
acacia wood oiled, furniture-friendly underside
madera de acacia aceitada, con base anti rayaduras
bois d'acacia huilé, avec revêtement antirayures



	Ø cm	↑ cm	€
33292	24,0	8	50,00
33293	24,0	16	65,00
33294	33,0	8	70,00
33295	33,0	16	96,00
33296	38,5	8	86,00
33297	38,5	16	112,00

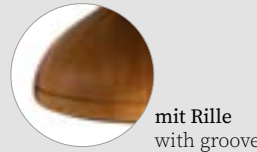

Frischhaltehaube / cover / campana / cloche



	Ø cm	↑ cm	fits to	€
06519	21	17	33292, 33293	30,00
06520	30	22	33294, 33295	40,00
06521	36	27	33296, 33297	74,00



Servier- und Tortenplatte

cake stand
porta pasteles
présentoir à gâteaux

matt poliert, drehbar, möbelschonende Unterseite
matt polished, rotating, furniture-friendly underside
pulido mate, giratoria, con base anti rayaduras
poli mat, pivotant, avec revêtement antirayures



	Ø cm	↑ cm	€
00463	30,5	9	47,00



Servier- und Tortenplatte

cake stand
porta pasteles
présentoir à gâteau

matt poliert / matt polished / pulido mate / poli mat



	Ø cm	↑ cm	€
00046	31	3	15,00

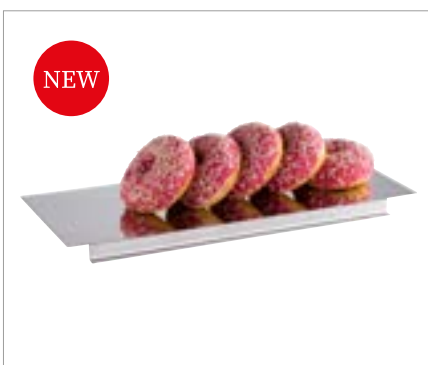

Auslagen- / Kuchenplatte

display / cake plate
expositor / plato para tartas
présentoir / assiette à gâteau

ideale Größe für Baumkuchen / Stollen
ideal size for Baumkuchen / Stollen
tamaño ideal para Baumkuchen / Stollen
taille idéale pour Baumkuchen / Stollen



	cm	↑ cm	€
00047	40 x 16	2,5	14,95

SUPER DOME



06525 Ø 30 cm

Frischhaltehaube „SUPER DOME“

cover
campana
cloche



schwere, glasklare Qualität
stable, crystal clear quality
muy resistente y transparencia cristalina
haute résistance et transparence

	Ø cm	↑ cm	€
06525	30	40	74,00

passende Servier-/Tortenplatten / suitable cake stands / porta pasteles compatibles /
présentoirs à gâteaux compatibles

	Ø cm	↑ cm	fits to	Farbe / Colour	€
00468	31,0	3,5	06525		18,40
33294	33,0	8,0	06525		70,00
33295	33,0	16,0	06525		96,00

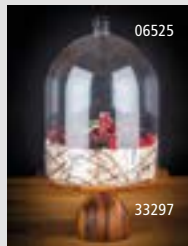

Präsentationsmöglichkeiten
presentation examples



Ø 21cm

tray
84942

Frischhaltehaube

cover
campana
cloche



schwere, glasklare Qualität
stable, crystal clear quality
calidad estable y transparencia cristalina
qualité stable et clarté cristalline

	Ø cm	↑ cm	fits to	€
06519	21	17	84941, 84942	30,00
06520	30	22	85034, 84177, 83891, 83890, 83884, 998, 975, 469, 468, 463, 462, 46	40,00
06521	36	27	84945, 84946	74,00



Besteckbehälter

cutlery box
recipiente para cubiertos
récipient pour couverts



Akazienholz, 4 Fächer (26 x 11,5 cm)

acacia wood, 4 compartments (26 x 11,5 cm)
madera de acacia, 4 compartimentos (26 x 11,5 cm)
bois d'acacia, 4 compartiments (26 x 11,5 cm)

	cm	↑ cm	Farbe / Colour		€
11952	51 x 28	13	nature		48,00
11951	51 x 28	13	vintage white		48,00



Besteckbehälter mit Deckel

cutlery box with cover
caja de cubiertos con tapa
range-couverts avec couvercle



Akazienholz, 4 Fächer (26 x 11,5 cm), mit Deckel

acacia wood, 4 compartments (26 x 11,5 cm), with cover
madera de acacia, 4 compartimentos (26 x 11,5 cm), con tapa
bois d'acacia, 4 compartiments (26 x 11,5 cm), avec couvercle

	cm	↑ cm	Farbe / Colour		€
11949	51 x 28	14,5	nature		74,00
11948	51 x 28	14,5	vintage white		70,00



GN 1/1 Besteckbehälter

GN 1/1 dispenser GN
GN 1/1 dispensador de cubiertos
GN 1/1 bac à couverts



in Handarbeit geflochten, 4 Mulden, Kunststoff-Geflecht, Drahtgestell, braun-schwarz

hand-woven, 4 troughs, plastic wickerwork, wire frame, brown-black
cesta trensada a mano, 4 compartimentos, mimbre de plástico, marco de alambre, marrón-negro
corbeille tressée à main, 4 compartiments, plastique tressé, armature en fil métallique, brun-noir

	cm	↑ cm	Farbe / Colour	GN	€
11966	53 x 32,5	9		1/1	41,00



GN 1/1 Besteckbehälter

GN 1/1 cutlery dispenser
GN 1/1 dispensador de cubiertos
GN 1/1 bac à couverts



4 Mulden, Kunststoff-Geflecht, Drahtgestell, beige

4 troughs, plastic wickerwork, wire frame, beige
4 compartimentos, mimbre de plástico, marco de alambre, beige
4 compartiments, plastique tressé, structure métallique, beige

	cm	↑ cm	Farbe / Colour	GN	€
11965	53 x 32,5	10		1/1	27,40

CUTLERY BOXES



GN 1/1 Besteckbehälter

GN 1/1 cutlery bin
GN 1/1 recipiente para cubiertos
GN 1/1 récipients pour couverts



4 Mulden

4 troughs
4 compartimentos
4 compartiments

	cm	↑ cm	Farbe / Colour	GN	€
11954	53 x 32,5	10	■	1/1	7,80
11955	53 x 32,5	10	■	1/1	7,20

3 Mulden, 3 Köcher

3 troughs, 3 cutlery baskets
3 compartimentos, 3 cestas para cubiertos
3 compartiments, 3 corbeilles à couverts

	cm	↑ cm	Farbe / Colour	GN	€
11960	53 x 32,5	10	■	1/1	7,80



Besteckbehälter

cutlery basket
recipiente para cubiertos
récipients pour couverts



4 Löcher inklusive 4 Edelstahl Köcher

4 holes including 4 stainless baskets
4 agujeros con 4 cestas de acero inoxidable
4 trous avec 4 corbeilles en acier inox

	cm	↑ cm	Farbe / Colour	€
93321	27 x 27	15	■	79,00



Besteckköcher

cutlery basket
cesta para cubiertos
corbeille à couverts



Polyethylen weiß / polyethylene white plastic / polietileno blanco / polyéthylène blanc

	Ø cm	↑ cm	€
11998	9,5	13,5	2,90

Edelstahl matt poliert / stainless steel matt polished / acero inoxidable pulido mate / acier inox poli mat

	Ø cm	↑ cm	€
11999	9,5	13,5	8,60



Besteckkasten „INDUSTRIAL“

cutlery box
caja para cubiertos
boîte pour couverts



Metall, schwarz

metal, black
metal, negro
métal, noir

	cm	↑ cm	litr.	€
40676	23,0 x 15,5	13,0	2,4	15,20



NAPKIN HOLDERS

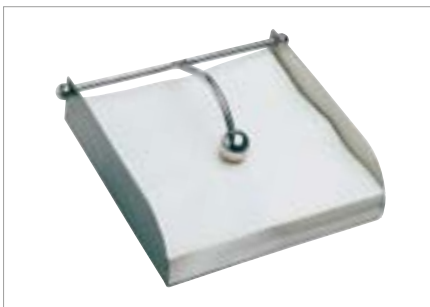

Serviettenhalter

napkin holder
servilletero
porte-serviettes

matt poliert / matt polished / pulido mate / poli mat



	cm	↑ cm	€
11730	17 x 17	5	19,00



Serviettenhalter

napkin holder
servilletero
porte-serviettes

hochglanzpoliert, für Servietten mit 1/8 Falz, Füße mit rutsch- und kratzfesten Gummierung
mirror polished, for napkins with 1/8 fold, feet with non-slip and scratch-resistant rubber coating

pulido brillante, para servilletas plegado 1/8, pies con revestimiento de goma antideslizante y anti rayaduras

poli brillant, pour serviettes pliage 1/8, pieds avec caoutchouc antidérapant et antirayures



	cm	↑ cm	€
11720	10 x 11,5	18,5	13,60



11767

Serviettenhalter „HERO“

napkin holder
servilletero
porte-serviettes

für ca. 65 Cocktailservietten, inklusive Beschwerer

for approx. 65 cocktail napkins, including weight

para aprox. 65 servilletas cocktail, con barrita de contrapeso

pour environ 65 serviettes cocktail, avec barre de contrepoids



	cm	↑ cm	€
11767	14,5 x 14,5	10	11,00

für ca. 95 Servietten 1/4 Falz, inklusive Beschwerer

for approx. 95 napkins 1/4 fold, including weight

para aprox. 95 servilletas de plegado 1/4, con barrita de contrapeso

pour environ 95 serviettes pliage 1/4, avec barre de contrepoids

	cm	↑ cm	€
11768	18,5 x 18,5	14	14,00



11768



inklusive Beschwerer
including weight

NAPKIN HOLDERS

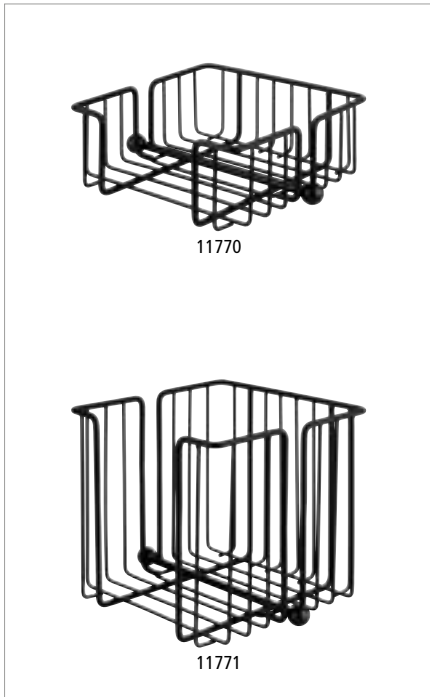

Serviettenhalter „URBAN“

napkin holder
servilletero
porte-serviettes

für ca. 50 Servietten 1/4 Falz, inklusive Beschwerer

for approx. 50 napkins 1/4 fold, including weight

para aprox. 50 servilletas de plegado 1/4, con barra de contrepeso

pour environ 50 serviettes pliage 1/4, avec barre de contrepoids



	cm	↑ cm	€
11770	19 x 19	7,5	10,60

für ca. 120 Servietten 1/4 Falz, inklusive Beschwerer

for approx. 120 napkins 1/4 fold, including weight

para aprox. 120 servilletas de plegado 1/4, con barra de contrepeso

pour environ 120 serviettes pliage 1/4, incl. barrie de contrepoids

	cm	↑ cm	€
11771	19 x 19	18	14,00



inklusive Beschwerer
including weight

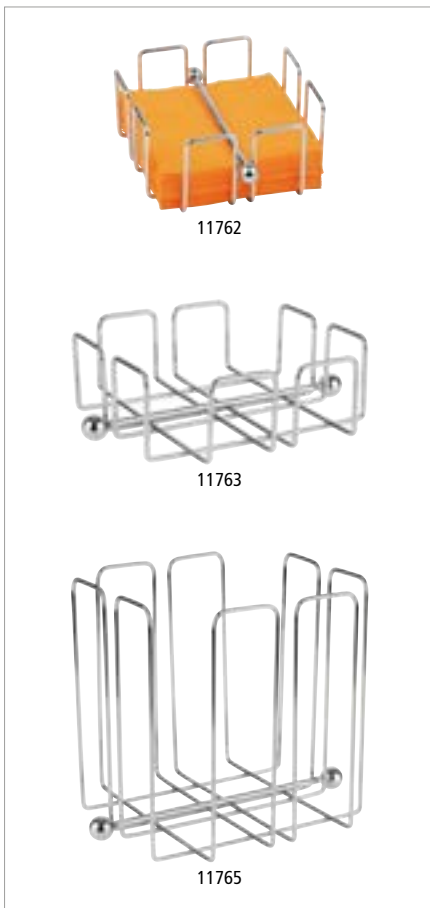

Serviettenhalter „WIRE“

napkin holder
servilletero
porte-serviettes

für ca. 50 Cocktailservietten, inklusive Beschwerer

for approx. 50 cocktail napkins, including weight

para aprox. 50 servilletas cocktail, con barra de contrepeso

pour environ 50 serviettes cocktail, avec barre de contrepoids



	cm	↑ cm	€
11762	14 x 14	6,5	6,90

für 50 Servietten 1/4 Falz, inklusive Beschwerer

for 50 napkins 1/4 fold, including weight

para 50 servilletas plegado 1/4, con barra de contrepeso

pour 50 serviettes pliage 1/4, avec barre de contrepoids

	cm	↑ cm	€
11763	19 x 19	6,5	7,20

für 150 Servietten 1/4 Falz, inklusive Beschwerer

for 150 napkins 1/4 fold, including weight

para 150 servilletas plegado 1/4, con barra de contrepeso

pour 150 serviettes pliage 1/4, avec barre de contrepoids

	cm	↑ cm	€
11765	19 x 19	19,0	11,80



inklusive Beschwerer
including weight



Serviettenhalter

napkin holder
servilletero
porte-serviettes

möbelschonende Unterseite, für ca. 20 Servietten, matt poliert

furniture-friendly underside, for approx. 20 napkins, matt polished

con base anti rayaduras, para aprox. 20 servilletas, pulido mate

avec revêtement antirayures, pour environ 20 serviettes, poli mat



	cm	↑ cm	€
11778	17 x 3	7	7,00



Serviettenhalter

napkin holder
servilletero
porte-serviettes



möbelschonende Unterseite, für ca. 30 Servietten, matt poliert
furniture-friendly underside, for approx. 30 napkins, matt polished
con base anti rayaduras, para aprox. 30 servilletas, pulido mate
avec revêtement antirayures, pour environ 30 serviettes, poli mat

	cm	↑ cm	€
11780	15 x 4,5	12,5	8,00



Serviettenhalter „ELEMENT“

napkin holder
servilletero
porte-serviettes



aus Beton, für ca. 50 Servietten, möbelschonende Unterseite
concrete, for approx. 50 napkins, furniture-friendly underside
hormigón, para aprox. 50 servilletas, con base anti rayaduras
béton, pour environ 50 serviettes, avec revêtement antirayures

	cm	↑ cm	€
11781	16 x 7,5	10	10,00



Table Caddy „ELEMENT“

table caddy
caddy de mesa
caddy de table



aus Beton, möbelschonende Unterseite
concrete, furniture-friendly underside
hormigón, con base anti rayaduras
béton, avec revêtement antirayures

	cm	↑ cm	inner size cm	€
11647	16,5 x 16	6,5	14,5 x 14	11,10



Table Caddy „ELEMENT“

table caddy
caddy de mesa
caddy de table



Beton, möbelschonende Unterseite, 2 Löcher je 6,5 cm
concrete, furniture-friendly underside, 2 holes each 6.5 cm
hormigón, con base anti rayaduras, 2 agujeros cada uno 6,5 cm
béton, avec revêtement antirayures, 2 trous de 6,5 cm chacun

	cm	↑ cm	inner size cm	€
11648	23,5 x 16	6,5	14,5 x 14	17,60



Buffet & Tableware Melamine



NERO.....	144	CIRCLE LA VIDA.....	189
CANCUN.....	147	MARONE.....	190
LOOPS.....	148	DARK WAVE.....	193
MOON.....	150	ZEN.....	195
EMMA.....	152	SINUS.....	199
APS+.....	154	HALFTONE.....	200
ASIA+.....	155	APART CASCADE.....	202
BLUE OCEAN.....	159	GLOBAL BUFFET.....	203
ARABESQUE.....	161	FLYING BUFFET.....	204
BAMBOO.....	163	FLOAT.....	205
STONE ART.....	164	PURE.....	207
AIKO.....	167	ENAMEL LOOK.....	211
ELEMENT.....	168	CASUAL.....	212
TIMBER.....	171	NATURAL COLLECTION....	214
OAK.....	172	BRÖTCHENSCHÜTTE.....	215
OAK LIGHT.....	173	CASUAL SEAFOOD.....	216
GLAMOUR.....	174	BALANCE.....	217
CROCKER.....	175	CUTLERY REST.....	218
FRIDA.....	177	PARTY SPOON.....	219
SLATE.....	185	MINI.....	221
SLATE ROCK.....	187	GN CONTAINER.....	224
ZERO DRIFTWOOD.....	188		



NERO



GN Tablett „NERO“

GN tray
GN bandeja
GN plateau



	cm	↑ cm	GN	€
85067	53,0 x 32,5	2,5	1/1	35,90
85068	32,5 x 26,5	2,5	1/2	19,20

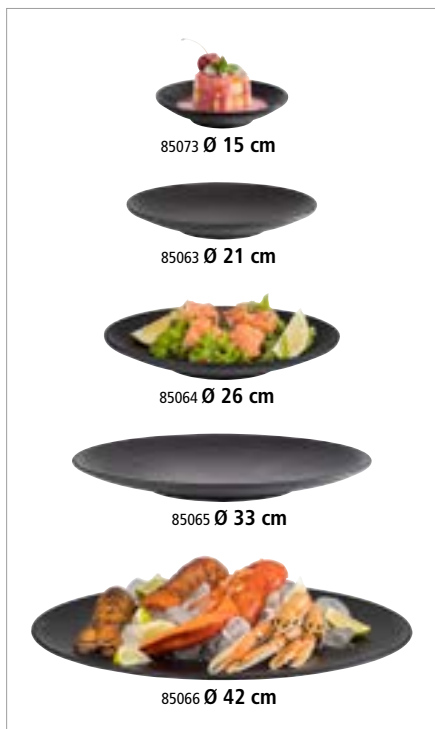
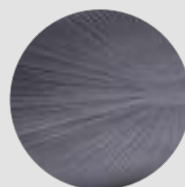

Teller „NERO“

plate
plato
assiette



	Ø cm	↑ cm	€
85073 NEW	15	3	5,80
85063	21	3	7,90
85064	26	3	8,80
85065	33	3,5	13,70
85066	42	3,5	24,70

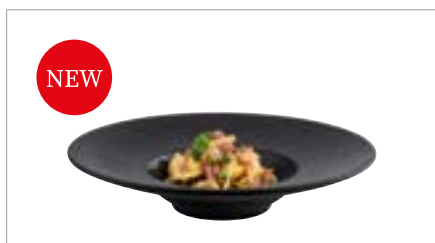

Teller „NERO“

plate
plato
assiette



	Ø cm	↑ cm	ltr.	€
85098	29	6	0,3	16,00



85069 0,5 ltr.

85070 0,9 ltr.

85061 1,7 ltr.

Schale „NERO“
bowl
cuenco
bol



	Ø cm	↑ cm	ltr.	€
85069	16	6,5	0,5	6,90
85070	19	8,0	0,9	10,40
85061	24	9,0	1,7	15,90

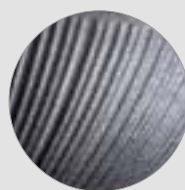
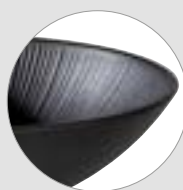

85060 0,8 ltr.

85062 2,2 ltr.

Schale „NERO“
bowl
cuenco
bol



	Ø cm	↑ cm	ltr.	€
85060	22,5	4,5	0,8	11,30
85062	30,0	7,0	2,2	21,40



85071 1,5 ltr.

85072 3,5 ltr.

Schale „NERO“
bowl, square
cuenco, cuadrado
bol creux carré



	cm	↑ cm	ltr.	€
85071	19,5 x 19,5	8	1,5	13,70
85072	25,0 x 25,0	11	3,5	22,70

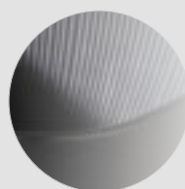
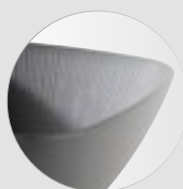

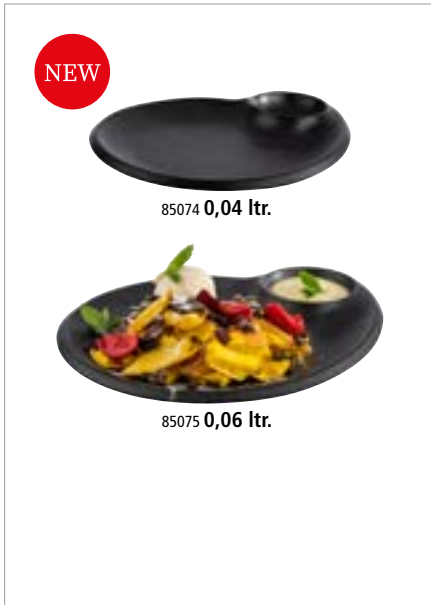

NEW



85074 **0,04 ltr.**



85075 **0,06 ltr.**

Teller „NERO“

plate
plato
assiette

mit integriertem Dipschälchen / Vertiefung
with integrated dip bowl / with notch
con cuenco para dip integrado / con ranura
avec ramequin intégré / avec encoche



	cm	↑ cm	ltr.	€
85074	24 x 20	2,5	0,04	9,00
85075	30 x 25	2,5	0,06	12,00

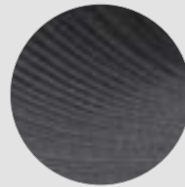
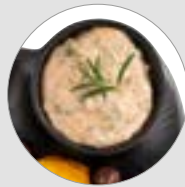

NEW



Tablett „NERO“

tray
bandeja
plateau

mit 2 integrierten Dipschälchen / Vertiefungen
with 2 integrated dip bowls / with 2 notches
con 2 cuencos para dip integrados / con 2 ranuras
avec 2 ramequins intégrés / avec 2 encoches



	cm	↑ cm	ltr.	€
85097	41 x 15	2,5	2 x 0,03	18,00

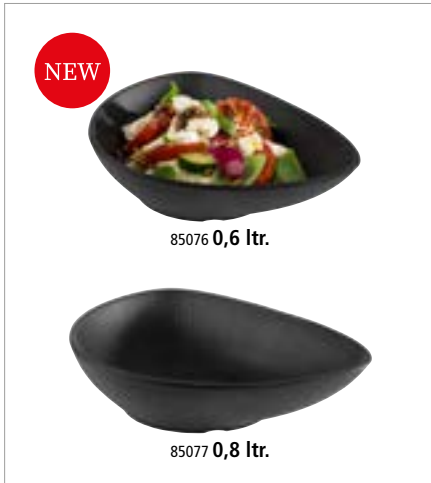

NEW



85076 **0,6 ltr.**



85077 **0,8 ltr.**

Schale „NERO“

bowl
cuenco
bol



	cm	↑ cm	ltr.	€
85076	23 x 18	5	0,6	12,00
85077	28 x 22	7	0,8	18,00

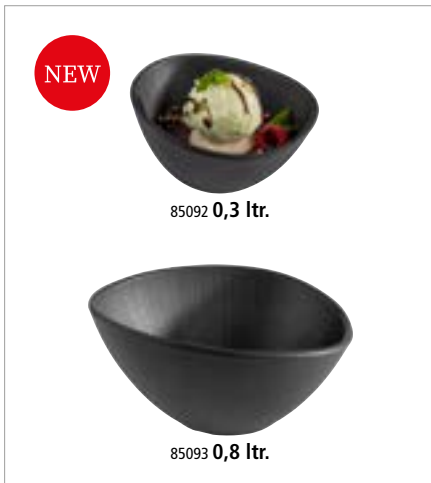
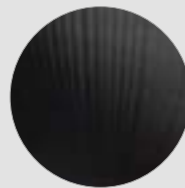

NEW



85092 **0,3 ltr.**



85093 **0,8 ltr.**

Schale „NERO“

bowl
cuenco
bol



	cm	↑ cm	ltr.	€
85092	14,5 x 12,5	8	0,3	6,80
85093	19,0 x 16,5	9	0,5	9,00





NEW

CANCUN



NEW

Tablett/Sushiboard „CANCUN“

tray
bandeja
plateauMAX
70°C

	cm	↑ cm	€
85200	23,5 x 13,5	1,5	8,80



NEW

Teller „CANCUN“

plate
plato
plateauMAX
70°C

	cm	↑ cm	€
85201	28 x 13,5	4,0	14,00



NEW

Schale „CANCUN“

bowl
cuenco
bolMAX
70°C

	Ø cm	↑ cm	ltr.	€
85205	15,0	7,0	0,5	8,00
85206	18,5	8,0	1,0	14,80
85207	20,5	6,5	1,0	16,70
85208	24,0	9,0	1,8	22,00

85205 0,5 ltr.

85207 1,0 ltr.

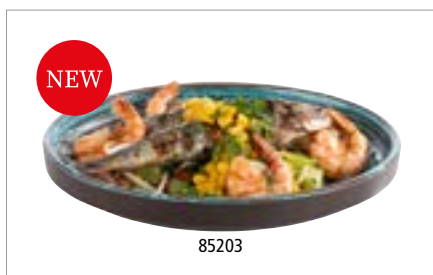

NEW

Teller „CANCUN“

plate
plato
plateauMAX
70°C

	Ø cm	↑ cm	€
85202	18,0	3,0	7,60
85203	23,0	3,5	15,00

85203



NEW

Teller „CANCUN“

plate
plato
plateauMAX
70°C

	Ø cm	↑ cm	€
85204	25,5	4,5	15,00



LOOPS

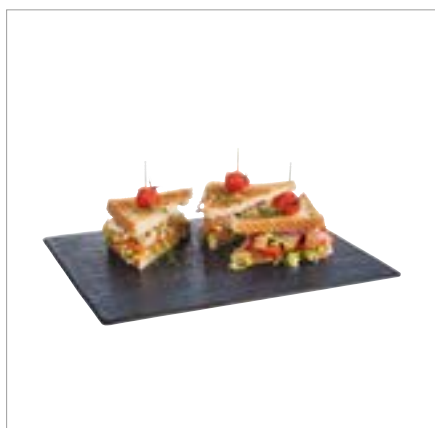

GN Tablett „LOOPS“

GN tray
GN bandeja
GN plateau



	cm	↑ cm	GN	€
85021	32,5 x 26,5	1,5	1/2	25,20

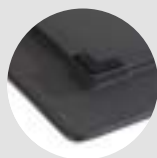

mit Antirutschfüßchen
with non-slip feet



Tablett/Sushiboard „LOOPS“

tray
bandeja
plateau



	cm	↑ cm	€
85025	23,5 x 13,5	1,5	8,80



85027

Teller „LOOPS“

plate
plato
assiette



	Ø cm	↑ cm	€
85027	22	2	9,00
85028	27	2	14,50



Teller „LOOPS“

plate
plato
plateau



	Ø cm	↑ cm	€
85024	34 x 15,5	4	19,60



Schale „LOOPS“

bowl
cuenco
bol



	Ø cm	↑ cm	ltr.	€
85026	18	3	0,25	7,60



Schale „LOOPS“

bowl
cuenco
bol



	Ø cm	↑ cm	ltr.	€
85029	20,5	6,5	1,0	16,70
85030	31,0	8,0	2,0	36,20



Schale „LOOPS“

bowl
cuenco
bol



	Ø cm	↑ cm	ltr.	€
85036	15,0	7,0	0,5	8,00
85037	18,5	8,0	1,0	14,80
85038	24,0	9,0	1,8	22,00



Teller „LOOPS“

plate
plato
plateau



	cm	↑ cm	€
85055	28 x 13,5	4,0	14,00



Teller „LOOPS“

plate
plato
plateau



	Ø cm	↑ cm	€
85056	23	3,5	15,00



Teller „LOOPS“

plate
plato
plateau



	Ø cm	↑ cm	€
85057	25,5	4,5	15,00

MOON



6 tlg.
6 pcs.



85080



85081

Servierset „MOON“, 6-teilig
 serving set, 6 pcs.
 set para servir, set de 6
 set de service, set de 6

6-teiliges Set: 3 Schalen + 3 Holzlöffel (Nanmu)

6 pcs.: 3 bowls + 3 wooden spoons (Nanmu)

set de 6: 3 cuencos + 3 cucharas de madera (Nanmu)

set de 6: 3 bols + 3 cuillères en bois (Nanmu)



	Ø cm	↑ cm	ltr.	Farbe / Colour	€/ set
85080	8	7,5	0,05		32,90
85081	8	7,5	0,05		32,90



85080



85080

84938

Tablett / tray



85081



2 tlg.
2 pcs.



85082



85083



85084

Servierset „MOON“, 2-teilig

serving set, 2 pcs.
set para servir, set de 2
set de service, set de 2

2-teiliges Set: 1 Schale + 1 klappbarer Deckel

2 pcs.: 1 bowl + 1 hinged cover

set de 2: 1 cuenco + 1 tapa con bisagra

set de 2: 1 bol + 1 couvercle avec charnières



	Ø cm	↑ cm	ltr.	Farbe / Colour	€/ set
85082	19	17,5	0,8		38,50
85083	19	17,5	0,8		38,50



85083



85082

klappbarer Deckel
hinged cover

Präsentationsmöglichkeit
presentation example

Klappdeckel „Moon“ mit Silikondichtung / hinged cover with silicone seal / tapa con bisagra y junta de silicona / couvercle avec charnières et joint en silicone

	Ø cm	↑ cm	fits to	€
85084	16	1,5	85082, 85083	5,80



85083

85082



85083



85082



85081

85080

84938
Tablett / tray

EMMA



85113

85116

85104

85105

85120

85101



85101 0,06 ltr



85104 0,50 ltr



85111 2,3 ltr

Schale „EMMA“ bowl cuenco bol



	Ø cm	↑ cm	ltr.	Farbe / Colour	€
85100	7,5	3,5	0,06	■	5,50
85101	7,5	3,5	0,06	■	5,50
85103	7,5	3,5	0,06	■	5,50
85104	14	6,5	0,5	■	9,90
85105	14	6,5	0,5	■	9,90
85107	14	6,5	0,5	■	9,90
85108	23	10,5	2,3	■	22,00
85109	23	10,5	2,3	■	22,00
85111	23	10,5	2,3	■	22,00

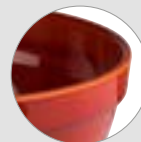
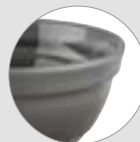
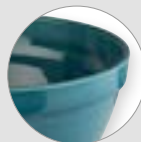



85120 GN 1/4



85121 GN 1/4



85124 GN 1/2



85127 GN 1/2

GN Tablett „EMMA“

GN tray
GN bandeja
GN plateau



	cm	↑ cm	GN	Farbe / Colour	€
85120	26,5 x 16,2	3	1/4		15,40
85121	26,5 x 16,2	3	1/4		15,40
85123	26,5 x 16,2	3	1/4		15,40
85124	32,5 x 26,5	3	1/2		24,20
85125	32,5 x 26,5	3	1/2		24,20
85127	32,5 x 26,5	3	1/2		24,20

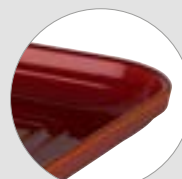
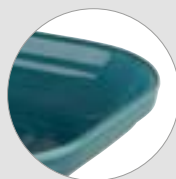

85128 1,5 ltr



85129 1,5 ltr



85133 3,5 ltr



85135 3,5 ltr

GN Schale „EMMA“

GN bowl
GN cuenco
GN bol



	cm	↑ cm	ltr.	GN	Farbe / Colour	€
85128	26,5 x 16,2	7,5	1,5	1/4		20,90
85129	26,5 x 16,2	7,5	1,5	1/4		20,90
85131	26,5 x 16,2	7,5	1,5	1/4		20,90
85132	32,5 x 26,5	7,5	3,5	1/2		28,60
85133	32,5 x 26,5	7,5	3,5	1/2		28,60
85135	32,5 x 26,5	7,5	3,5	1/2		28,60

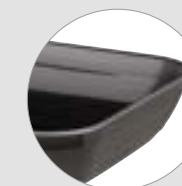
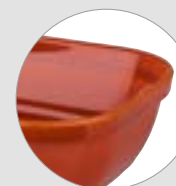
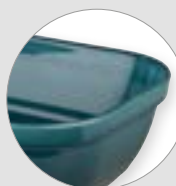

❄️ Cooling bowl ❄️



APS+



GN 1/4 Schale „APS+“

GN 1/4 bowl
GN 1/4 cuenco
GN 1/4 bol



	cm	↑ cm	GN	ltr.	Farbe / Colour	€
15116	26,5 x 16,2	7	1/4	1,5		18,40

passender Deckel / suitable lid / tapa adecuada / couvercle approprié

	cm	↑ cm	GN		€
15348	26,5 x 16,2	1,5	1/4		7,00



Schale, quadratisch „APS+“

bowl, square
cuenco cuadrado
bol carré



	cm	↑ cm		ltr.	Farbe / Colour	€
15110	6,5 x 6,5	6		0,15		2,70
15111	9,0 x 9,0	4		0,15		3,00
15112	13,0 x 13,0	7		0,60		7,40



Schale, quadratisch „APS+“

bowl, square
cuenco cuadrado
bol carré



	cm	↑ cm		ltr.	Farbe / Colour	€
15113	20,0 x 20,0	7		1,5		18,40
15215	13,0 x 13,0	7		0,6		10,40
15216	20,0 x 20,0	7		1,5		24,40
15217	24,0 x 24,0	9		3,5		36,80



Schale, rund „APS+“

bowl, round
cuenco, redondo
bol rond



	cm	↑ cm		ltr.	Farbe / Colour	€
15100	6,5	6		0,15		2,50
15101	9,0	4		0,15		2,70
	Ø cm	↑ cm		ltr.	Farbe / Colour	€
15200	6,5	6		0,15		3,00
15201	9,0	4		0,15		3,50





GN Tablett „ASIA PLUS“

GN tray
GN bandeja
GN plateau



	cm	↑ cm	GN	Farbe / Colour	€
15449	53,0 x 32,5	3	1/1		41,40
15450	32,5 x 26,5	3	1/2		22,90
15451	32,5 x 17,6	3	1/3		17,10
15452	26,5 x 16,2	3	1/4		13,40
15453	35,4 x 32,5	3	2/3		29,30
15454	53,0 x 16,2	3	2/4		26,70
15455	53,0 x 32,5	3	1/1		53,40
15456	32,5 x 26,5	3	1/2		26,20
15457	32,5 x 17,6	3	1/3		21,80
15458	26,5 x 16,2	3	1/4		18,00
15460	53,0 x 16,2	3	2/4		33,90



Schale „ASIA PLUS“

bowl
cuenco
bol



	Ø cm	↑ cm	ltr.	Farbe / Colour	€
15400	7,5	3,5	0,06		2,60
15401	9,5	4,5	0,13		3,70
15402	13,0	5,5	0,35		6,30
15403	16,0	7,0	0,60		8,60
15404	20,0	8,0	1,10		13,80
15416	7,5	3,5	0,06		2,60
15417	9,5	4,5	0,13		3,70
15418	13,0	5,5	0,35		6,30
15419	16,0	7,0	0,60		8,60
15420	20,0	8,0	1,10		13,80
15421	24,0	9,5	2,20		20,70



Teller „ASIA PLUS“

plate
plato
assiette



	Ø cm	↑ cm	Farbe / Colour	€
15424	11,0	2		3,30
15425	16,0	2		5,80



Bento Box „ASIA PLUS“



	Ø cm	↑ cm	ltr.	Farbe / Colour	€
15461	7,5	3,0	0,04		2,30
15462	7,5	6,5	0,13		3,30
15467	7,5	3,0	0,04		3,30



Bento Box „ASIA PLUS“



	cm	↑ cm	ltr.	Farbe / Colour	€
15473	7,5 x 7,5	3,0	0,05		2,60
15474	7,5 x 7,5	6,5	0,16		3,50
15485	7,5 x 7,5	3,0	0,05		4,10
15486	7,5 x 7,5	6,5	0,16		5,10
15475	15,5 x 7,5	3,0	0,10		4,10
15477	15,5 x 9,5	3,0	0,15		4,40



GN Buffetständer „ASIA PLUS“

GN buffet stand
GN soporte para buffet
GN présentoir buffet



Auf der kurzen und der langen Seite aufstellbar!

Can stay on the short or long side!
Se puede colocar por la parte corta o larga!
Se peut installer sur le côté court ou long!

	cm	GN	Farbe / Colour	€
15501	53,0 x 32,5 / 53,0 x 16,2	1/1 / 2/4		36,00
15502	32,5 x 26,5 / 26,5 x 16,2	1/2 / 1/4		22,60
15503	32,5 x 17,5 / 35,4 x 32,5	1/3 / 2/3		29,00
15504	53,0 x 32,5 / 53,0 x 16,2	1/1 / 2/4		29,90
15505	32,5 x 26,5 / 26,5 x 16,2	1/2 / 1/4		17,80
15506	32,5 x 17,5 / 35,4 x 32,5	1/3 / 2/3		22,80

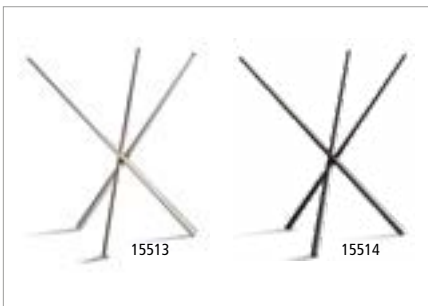

Buffetständer „ASIA PLUS“

buffet stand
soporte para buffet
présentoir buffet



	Ø cm	↑ cm	Farbe / Colour	€
15513	20,5 / 16,5	20	stainless steel	16,80
15514	20,5 / 16,5	20		15,60



Korb / Ständer „APS PLUS“

basket / riser
cesta / soporte
corbeille / support



	Ø cm	↑ cm	Farbe / Colour	€
15320	10,5 / 8	8		16,40
15324	10,5 / 8	8		16,40
15322	10,5 / 8	8		15,00



BLUE OCEAN



Da geht die Sonne auf!

Maritime Aquatöne, Farbverläufe und klassisches Blau-Weiß erinnert an eine griechische Taverne in der Ägäis.

The sun is rising!

Maritime aqua tones, gradients and classic blue and white reminiscent of a Greek tavern in the Aegean Sea.

¡Está saliendo el sol!

Los tonos marinos, los degradados de color, el clásico azul y blanco recuerdan a una taberna griega en el mar Egeo.

Le soleil se lève!

Les tons maritimes, les dégradés de couleurs, le bleu et le blanc classiques, tout rappellent une taverne grecque de la mer Égée.

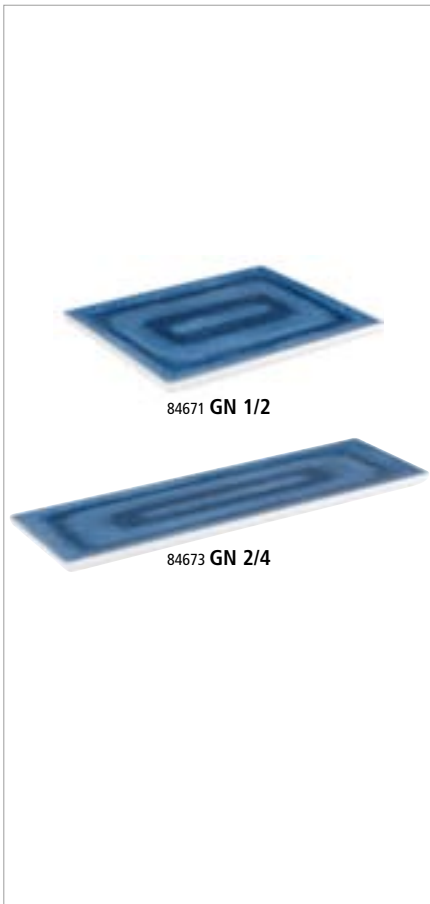

GN Tablett „BLUE OCEAN“

GN tray
GN bandeja
GN plateau



	cm	↑ cm	GN	€
84671	32,5 x 26,5	2	1/2	27,60
84672	32,5 x 17,6	2	1/3	20,50
84673	53,0 x 16,2	2	2/4	28,80

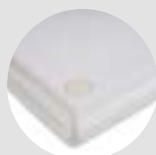

mit Antirutschfüßchen
with non-slip feet

BLUE OCEAN



Tablett „BLUE OCEAN“

tray
bandeja
plateau



	cm	↑ cm	€
84676	48 x 35,5	3	27,60



Schale „BLUE OCEAN“

bowl
cuenco
bol

	Ø cm	↑ cm	ltr.	€
84677	15	7,5	0,6	8,00
84678	30,5	9	3	20,70



Teller „BLUE OCEAN“

plate
plato
assiette



	Ø cm	↑ cm	€
84674	21,5	2	10,60
84675	26,5	2	14,30



ARABESQUE



Beim Anblick der mediterranen Melamin Serie ARABESQUE bekommt man direkt Lust auf eine Tapas-Party. Mit seinem spanischen Charme und den wundervoll ausgearbeiteten Details holen Sie sich ein Stück Spanien auf Ihr Buffet.

When looking at the Mediterranean melamine series ARABESQUE, the longing for a tapas party resurfaces. With its Spanish charm and the beautifully crafted details, you get a slice of Spain on your buffet.

Al ver la serie mediterránea de melamina ARABESQUE, se obtiene un dicho antojo por una fiesta de tapas. Con su encanto español y los detalles bellamente elaborados, obtendrá un trozo de España en su buffet.

En regardant la série de mélamine méditerranéenne ARABESQUE, vous obtenez envie de préparer une fête de tapas. Avec son charme espagnol et les détails joliment ouverts, vous aurez une tranche d'Espagne sur votre buffet.



GN Tablett „ARABESQUE“

GN tray
GN bandeja
GN plateau



	cm	↑ cm	GN	€
84680	53,0 x 32,5	2	1/1	50,60
84681	32,5 x 26,5	2	1/2	27,60
84682	32,5 x 17,6	2	1/3	20,70
84683	53,0 x 16,2	2	2/4	28,80

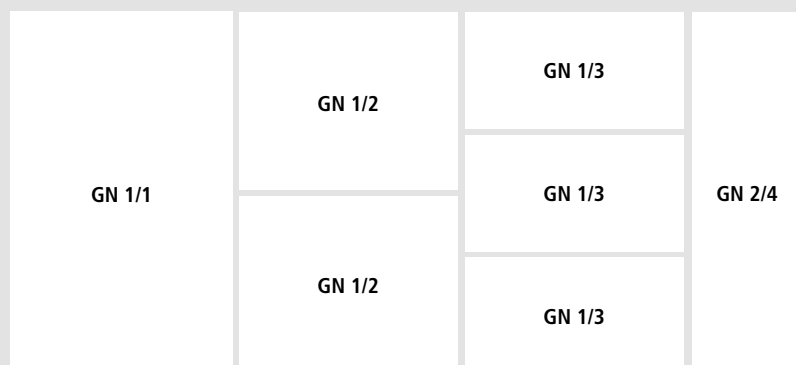

ARABESQUE

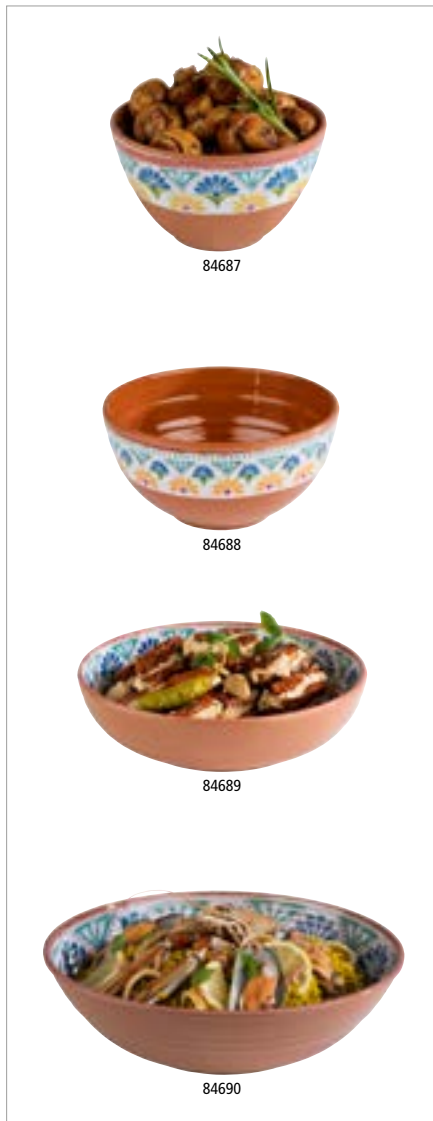

84687

84688

84689

84690

Schale „ARABESQUE“

bowl
cuenco
bol



	∅ cm	↑ cm	ltr.	€
84687	10,0	6,0	0,2	5,30
84688	15,5	8,0	0,8	8,00

	∅ cm	↑ cm	ltr.	€
84689	20,5	5,5	1,1	11,80
84690	31,0	9,0	3,0	24,20



Teller „ARABESQUE“

plate
plato
assiette



	cm	↑ cm	€
84686	38 x 15,5	2	16,10



84684

84685

Teller „ARABESQUE“

plate
plato
assiette



	∅ cm	↑ cm	€
84684	21,5	2	10,30
84685	26,5	2	14,30

BAMBOO



84816

Schale „BAMBOO“
bowl
cuenco
bol



	cm	↑ cm	ltr.	€
84815	10,5 x 10,0	3,0	0,03	3,00
84816	17,5 x 15,5	5,5	0,2	7,90



Schale „BAMBOO“
bowl
cuenco
bol



	Ø cm	↑ cm	ltr.	€
84819	30,5	8,5	2	22,40

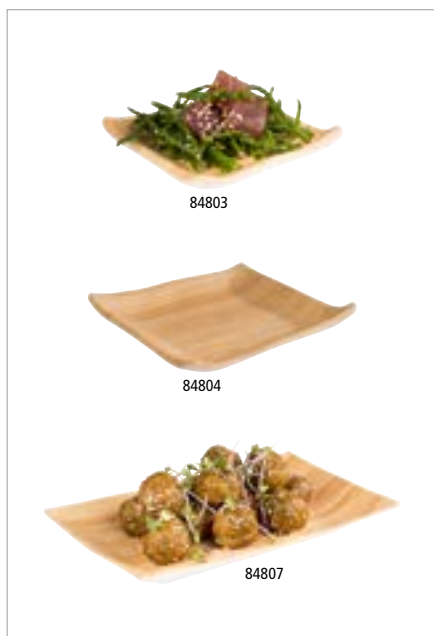

84803

84804

84807

Tablett „BAMBOO“
tray
bandeja
plateau



	cm	↑ cm	€
84803	10,0 x 10,0	2,0	3,00
84804	14,5 x 14,5	2,5	4,50
84805	31,0 x 10,5	2,0	8,80
84806	21,0 x 13,0	3,0	6,20
84807	24,5 x 15,5	3,0	9,70
84808	34,5 x 21,5	3,0	19,50

STONE ART



Teller „STONE ART“
plate
plato
assiette



	Ø cm	↑ cm		€
84510	19	2		8,30
84511	25	2		12,90
84512	30	2		18,40



Teller „STONE ART“
plate
plato
assiette



	Ø cm	↑ cm	ltr.	€
84509	15,5	2,5	0,15	6,30
84514	20,0	4,5	0,60	11,40



Teller „STONE ART“
plate
plato
assiette



	Ø cm	↑ cm		€
84515	24,5	3,5		14,30



Teller „STONE ART“
plate
plato
assiette



	cm	↑ cm		€
84517	33 x 32,5	3		26,30



Schale „STONE ART“

bowl
cuenco
bol



	∅ cm	↑ cm	ltr.	€
84523	8	3	0,07	2,90



Schale „STONE ART“

bowl
cuenco
bol



	∅ cm	↑ cm	ltr.	€
84524	12	6	0,3	5,60



Schale „STONE ART“

bowl
cuenco
bol



	∅ cm	↑ cm	ltr.	€
84525	15	7,5	0,6	6,90



Schale „STONE ART“

bowl
cuenco
bol



	cm	↑ cm	ltr.	€
84526	23 x 19	6,5	0,6	12,50



Schale „STONE ART“

bowl
cuenco
bol



	cm	↑ cm	ltr.	€
84528	28,5 x 21	7,5	1,2	20,70



84529

Schale „STONE ART“

bowl
cuenco
bol



	cm	↑ cm	ltr.	€
84529	19 x 19	6,0	0,5	13,60
84530	24 x 24	6,5	1,1	18,90

STONE ART



GN Tablett „STONE ART“

GN tray
GN bandeja
GN plateau



	cm	↑ cm	GN	€
84519	53,0 x 32,5	1,5	1/1	49,40
84520	32,5 x 26,5	1,5	1/2	27,10
84522	53,0 x 16,2	1,5	2/4	28,20
84521	32,5 x 17,6	1,5	1/3	19,90



mit Antirutschfüßchen
with non-slip feet



GN Abdeckhaube

GN cover
GN cubierta
GN cloche



passend für GN Tablett, glasklarer Kunststoff, nahezu unzerbrechlich

suitable for GN trays, clear plastic, nearly unbreakable

apto para bandejas GN, plástico transparente, muy resistente a la rotura

pour plateaux GN, plastique transparent, très résistant à la casse

	cm	↑ cm	mm	GN	€
11043	32,5 x 17,6	10,5	3	1/3	17,00
11044	53,0 x 16,2	10,5	3	2/4	23,00

	cm	↑ cm	mm	GN	€
11041	32,5 x 26,5	9,5	3	1/2	23,00
11042	53,0 x 32,5	9,5	3	1/1	32,00

AIKO



Schalen der Serie Aiko eignen sich perfekt zum Präsentieren von leckeren Saucen, Pasten oder frischem Sushi. Aber auch kleines Fingerfood kann hübsch präsentiert und angerichtet werden.

Bowls from the Aiko series are perfect for presenting delicious sauces, pastes or fresh sushi. Also small finger food can be presented and served in a pretty way.

Los cuencos de la serie Aiko son perfectos para presentar deliciosas salsas, pastas o sushi fresco. Pero también se pueden presentar y servir de forma atractiva pequeños aperitivos.

Les bols de la série Aiko sont parfaits pour présenter de délicieuses sauces, des pâtes ou des sushis frais. Mais les petits apéritifs peuvent également être présentés et servis de manière attrayante.



84329 0,07 ltr.



84331 0,2 ltr.

Schale „AIKO“

bowl
cuenco
bol

Steinoptik

appearance stoneware

su aspecto recuerda al gres

l'aspect de la mélamine rapelle le grès



	Ø cm	↑ cm	ltr.	Farbe / Colour	€
84329	8,0	4	0,07	■	3,80
84331	11,5	6	0,20	■	5,10



84335 0,6 ltr.



84337 1,2 ltr.

Schale „AIKO“

bowl
cuenco
bol

Steinoptik

appearance stoneware

su aspecto recuerda al gres

l'aspect de la mélamine rapelle le grès



	Ø cm	↑ cm	ltr.	Farbe / Colour	€
84335	16,0	7	0,6	■	8,30
84337	20,5	8	1,2	■	12,70

ELEMENT



Betonoberflächen auf dem Buffet für den Kontakt mit Lebensmitteln?
ELEMENT macht es möglich.
 Bestens geeignet im modernen und urbanen Ausstattungsumfeld.

Concrete surfaces on the buffet for food contact?
ELEMENT makes it possible.
 Ideally suited for modern and urban environments.

¿Superficies de hormigón en el buffet y tener contacto con alimentos?
ELEMENT lo hace possible.
 Ideal para ambientes modernos y urbanos.

Des surfaces en béton sur le buffet et destinées au contact alimentaire?
ELEMENT le rend possible.
 Idéal pour les environnements modernes et urbains.



Schale „ELEMENT“

bowl
 cuenco
 bol



	cm	↑ cm	ltr.	€
84825	∅ 8,0	2,0	0,01	1,80
84826	10,5 x 10,0	3,0	0,02	3,40
84820	9,0 x 7,0	3,0	0,03	3,40
84821	10,5 x 10,5	3,0	0,04	3,80
84827	17,5 x 15,5	5,5	0,18	7,90



Schale „ELEMENT“

bowl
 cuenco
 bol



	∅ cm	↑ cm	ltr.	€
84828	16	7	0,5	9,20
84829	28	12	3,0	26,70



82831 3,0 ltr

Schale „ELEMENT“

bowl
cuenco
bol



	cm	↑ cm	ltr.	€
84830	19 x 19	9	1,5	26,70
84831	25 x 25	12	3,8	40,30



Tablett „ELEMENT“

tray
bandeja
plateau



	cm	↑ cm	€
84824	31 x 10,5	1,5	10,20



GN Tablett „ELEMENT“

GN tray
GN bandeja
GN plateau



	cm	↑ cm	GN	€
84400	53,0 x 32,5	3,5	1/1	44,00
84401	32,5 x 26,5	3,5	1/2	24,20
84402	32,5 x 17,5	3,5	1/3	17,80
84403	26,5 x 16,2	3,5	1/4	13,80
84404	53,0 x 16,2	3,5	2/4	26,70



Schale „ELEMENT LOOK“

bowl
cuenco
bol



	Ø cm	↑ cm	ltr.	€
84835	21,5	5,5 / 9,5	0,7	27,40
84836	26,0	7,0 / 12,5	1,45	33,00
84837	30,0	8,5 / 14,5	2,3	47,00

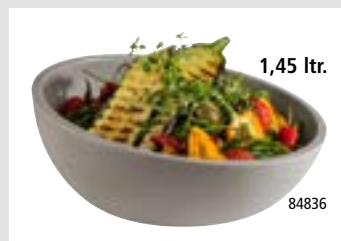

1,45 ltr.

84836

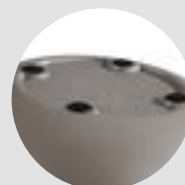

mit Antirutschfüßchen
with non-slip feet



GN Tablett „ELEMENT“

GN tray
GN bandeja
GN plateau



	cm	↑ cm	GN	Farbe / colour	€
84986	56,0 x 35,5	1,5	1/1	■	39,00
84988	35,5 x 29,0	1,5	1/2	■	19,00

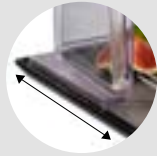

mit Antirutschrinne für Hauben
with non-slip groove for covers

passende Hauben / suitable covers / campanas adecuadas / cloches appropriées

	cm	↑ cm	GN	€
11010	53,0 x 32,5	19	1/1	62,00
11027	53,0 x 32,5	9,5	1/1	54,00
11041	32,5 x 26,5	9,5	1/2	23,00
11021	33,0 x 28,0	17	1/2	29,00



GN Tablett „BUFFET PRO“

GN tray
GN bandeja
GN plateau

mit Mulde für Besteckablage
with tray for cutlery storage
con espacio reposa cubiertos
avec espace repose-ustensiles



	cm	↑ cm	GN	Farbe / colour	€
85145	53,0 x 32,5	1,5	1/1	■	38,00
85146	32,5 x 26,5	1,5	1/2	■	19,00



mit Mulde für Vorlagegabel
with tray for cutlery storage



Präsentationsmöglichkeit
presentation example

TIMBER



Tablett „TIMBER“
tray
bandeja
plateau



	cm	↑ cm	€
84256	70 x 26	3	71,30



Tablett „TIMBER“
tray
bandeja
plateau



	cm	↑ cm	€
84269	65 x 26	3	36,80



Tablett „TIMBER“
tray
bandeja
plateau



	Ø cm	↑ cm	€
84266	35	3	30,40



Tablett „TIMBER“
tray
bandeja
plateau



	cm	↑ cm	€
84268	44 x 25	1,5	24,20

OAK



Tablett „OAK“

tray
bandeja
plateau



	cm	↑ cm	Griff / handle cm	€
84178	40 x 20	1,5	13	31,00
84179	48 x 20	1,5	13	38,00



Tablett „OAK“

tray
bandeja
plateau



	Ø cm	↑ cm	Griff / handle cm	€
84177	30	1,5	12	25,30



Schale „OAK“

bowl
cuenco
bol



	cm	↑ cm	€
84434	11,5 x 7,0	2,5	4,60

OAK LIGHT

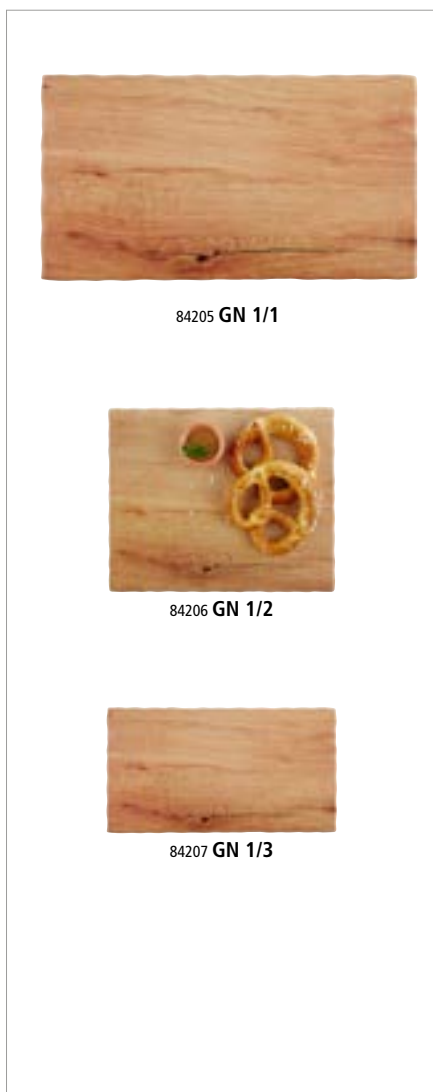

GN Tablett „OAK LIGHT“

GN tray
GN bandeja
GN plateau



	cm	↑ cm	GN	€
84205	53,0 x 32,5	1,5	1/1	43,00
84206	32,5 x 26,5	1,5	1/2	22,00
84207	32,5 x 17,6	1,5	1/3	15,60
84208	26,5 x 16,2	1,5	1/4	12,60
84209	53,0 x 16,2	1,5	2/4	25,00



Tablett „OAK LIGHT“

tray
bandeja
plateau



	cm	↑ cm	€
84265	65 x 26	3	36,80



GLAMOUR

84377

84381



Schale „GLAMOUR“

bowl
cuenco
bol



	∅ cm	↑ cm	ltr.	€
84365	8	3	0,05	2,00



Schale „GLAMOUR“

bowl
cuenco
bol



	∅ cm	↑ cm	ltr.	€
84366	12	5	0,25	2,60



84377

84378

Tablett „GLAMOUR“

tray
bandeja
plateau



	cm	↑ cm	€
84377	22 x 12	3,0	4,00
84378	37 x 11	2,5	10,90



84380

84381

Tablett „GLAMOUR“

tray
bandeja
plateau



	cm	↑ cm	€
84380	25,0 x 15,5	1,5	3,60
84381	30,5 x 19,0	1,5	5,60



Tablett „GLAMOUR“

tray
bandeja
plateau



	cm	↑ cm	€
84379	30 x 11	3	6,00

CROCKER



Servier- und Buffetartikel in Tonoptik, brauner Rand. Die Oberfläche ist innen und außen fein-matt, fühlt sich an wie Ton.

Serving and buffet items, an imitation of clay, with a brown border. The surface is inside and outside fine-matt. Feels like real clay.

Artículos de servicio y buffet, imitación barro y con borde marrón. La superficie de dentro y de fuera es de deslustre fino. Parece barro natural.

Pièces de service et pour le buffet imitation argile avec bord marron. La surface est à l'intérieur et à l'extérieur bien-matte.



Teller „CROCKER“

plate
plato
assiette



	cm	↑ cm	Farbe / Colour	€
84567	14 x 13	2,5		3,90
84568	14 x 13	2,5		3,90



Teller „CROCKER“

plate
plato
assiette



	Ø cm	↑ cm	ltr.	Farbe / Colour	€
84575	20,5	3	0,50		7,40
84576	20,5	3	0,50		7,40

CROCKER



Schale „CROCKER“

bowl
cuenco
bol



	Ø cm	↑ cm	ltr.	Farbe / Colour	€
84573	16,5	4	0,50		6,80
84574	16,5	4	0,50		6,80



Schale „CROCKER“

bowl
cuenco
bol



	Ø cm	↑ cm	ltr.	Farbe / Colour	€
84569	12,5	6	0,37		4,20
84570	12,5	6	0,37		4,20
84571	16,0	7	0,70		7,00
84572	16,0	7	0,70		7,20
84577	21,0	8	1,45		12,00
84578	21,0	8	1,45		12,00



Blattschale „CROCKER“

leaf
fuente en forma de hoja
plateau feuille



	cm	↑ cm	ltr.	Farbe / Colour	€
84579	30,5 x 10	7,5	0,17		7,90
84580	30,5 x 10	7,5	0,17		7,90
84581	42 x 14	9,5	0,65		18,40
84582	42 x 14	9,5	0,65		18,40

FRIDA



FRIDA

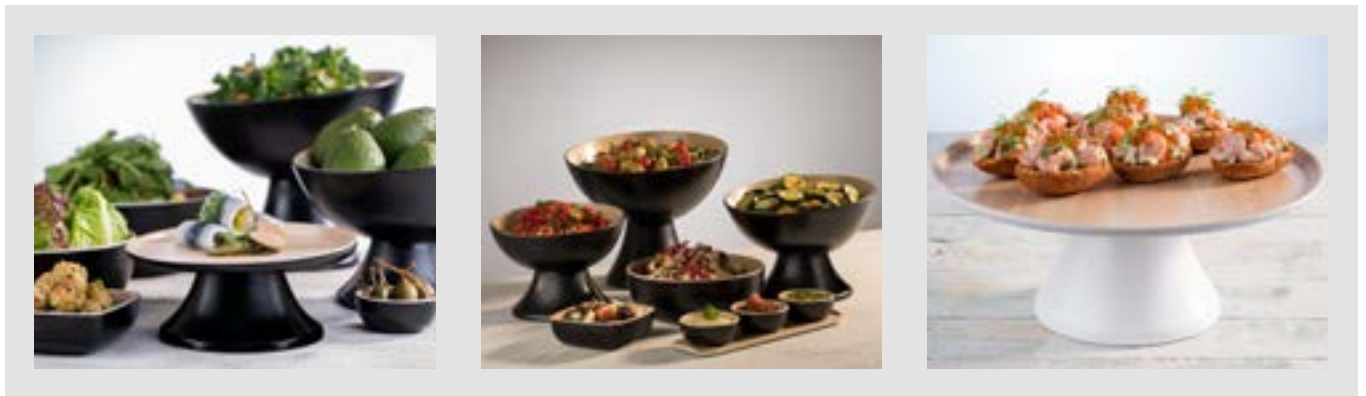



Schale „FRIDA LOCK“

bowl
cuenco
bol



Schalen lassen sich durch Drehmechanismus mit dem Ständer fest verbinden

bowls can be firmly connected to the stand by a turning mechanism

los cuencos se pueden conectar firmemente al soporte mediante un mecanismo giratorio

les bols peuvent être solidement reliés au présentoir au moyen d'un mécanisme rotatif

	Ø cm	↑ cm	ltr.	Farbe / Colour	€
84920	21,5	7/8,5	1,0		34,00
84921	21,5	7/8,5	1,0		34,00
84922	25,0	8/11	1,6		42,60
84923	25,0	8/11	1,6		42,60
84924	28,5	10/14	2,6		46,60
84925	28,5	10/14	2,6		46,60

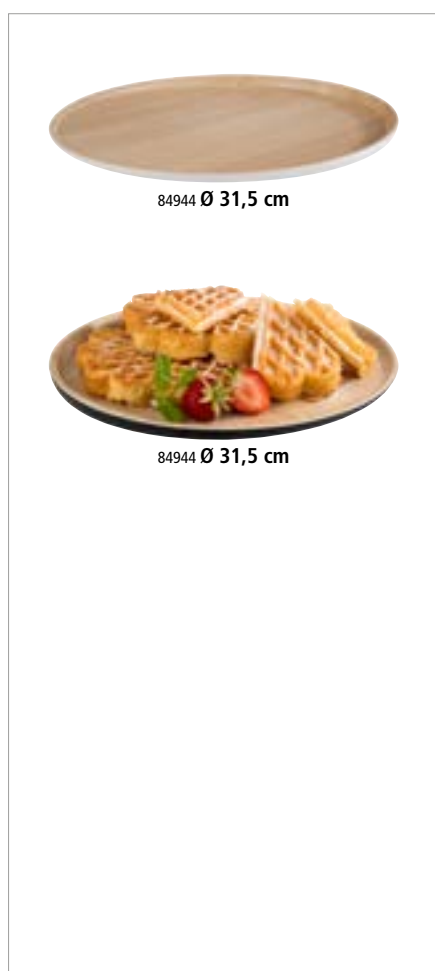

Tablett / Platte „FRIDA LOCK“

tray
bandeja
plateau



Tablets lassen sich durch Drehmechanismus mit dem Ständer fest verbinden

trays can be firmly connected to the stand by a turning mechanism

las bandejas se pueden conectar firmemente al soporte mediante un mecanismo giratorio

les plateaux peuvent être solidement reliés au présentoir au moyen d'un mécanisme rotatif

	Ø cm	↑ cm	Farbe / Colour	€
84943	31,5	1,5/2,5		30,50
84944	31,5	1,5/2,5		30,50





Ständer „FRIDA LOCK“
stand
soporte
présentoir



	Ø cm	↑ cm	Farbe / Colour	€
84926	16,5	8	White	9,90
84927	16,5	8	Black	9,90



Ständer „FRIDA LOCK“
stand
soporte
présentoir



	Ø cm	↑ cm	Farbe / Colour	€
84928	16,5	12	White	17,00
84929	16,5	12	Black	17,00



Haube
cover
campana
cloche



	Ø cm	↑ cm	fits to	€
06519	21	17	84941, 84942	30,00
06520	30	22	00468, 00469, 84943, 84944	40,00
06521	36	27	84945, 84946	74,00
	Ø cm	↑ cm	fits to	€
06525	30	40	00468, 00469, 84943, 84944	32,00



84605 0,25 ltr.



84608 0,45 ltr.



84609 1,2 ltr.

Schale „FRIDA“

bowl
cuenco
bol

	Ø cm	↑ cm	ltr.	Farbe / Colour	€
84605	12,5	4,5	0,25		11,00
84606	12,5	4,5	0,25		11,00
84607	15,0	5,5	0,44		18,00
84608	15,0	5,5	0,44		18,00
84609	20,0	7,5	1,20		27,00
84610	20,0	7,5	1,20		27,00

passende Deckel / suitable lid / tapa adecuada / couvercle approprié

	Ø cm	↑ cm	fits to	€
84963	13,0	2,5	84605, 84606	3,40
84964	16,0	2,5	84607, 84608	3,80



84612 2,2 ltr.



84613 3,4 ltr.

Schale „FRIDA“

bowl
cuenco
bol

	Ø cm	↑ cm	ltr.	Farbe / Colour	€
84611	22,0	10,5	2,2		29,30
84612	22,0	10,5	2,2		29,30
84613	26,5	10,5	3,4		36,70
84614	26,5	10,5	3,4		36,70

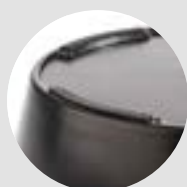
mit Antirutschfüßchen
with non-slip feet

84930 0,1 ltr.



84933 1,8 ltr.



84934 4,7 ltr.

Schale „FRIDA“

bowl
cuenco
bol

	Ø cm	↑ cm	ltr.	Farbe / Colour	€
84930	8,5	3,5	0,1		3,80
84931	8,5	3,5	0,1		3,80
84932	21,5	7,5	1,8		26,00
84933	21,5	7,5	1,8		26,00
84934	30,0	9,5	4,7		42,80
84935	30,0	9,5	4,7		42,80

passende Deckel / suitable lid / tapa adecuada / couvercle approprié

	Ø cm	↑ cm	fits to	€
84962	9,0	2,5	84930, 84931	3,10



Schale „FRIDA“

bowl
cuenco
bol



	cm	↑ cm	ltr.	Farbe / Colour	€
84936	12,5 x 12,5	4,5	0,37		7,60
84937	12,5 x 12,5	4,5	0,37		7,60
84558	16,5 x 16,5	5,5	0,85		11,50
84559	16,5 x 16,5	5,5	0,85		11,50
84561	25,0 x 25,0	7,5	2,65		21,40
84562	25,0 x 25,0	7,5	2,65		21,40

passende Deckel / suitable lid / tapa adecuada / couvercle approprié

	cm	↑ cm	fits to	€
84965	13,0 x 13,0	2,5	84936, 84937	3,10
84966	17,0 x 17,0	2,5	84558, 84559	3,40



GN Schale „FRIDA“

GN bowl
GN cuenco
GN bol



	cm	↑ cm	ltr.	GN	Farbe / Colour	€
84555	17,6 x 10,8	5,5	1,5	1/9		10,20
84556	17,6 x 10,8	5,5	1,5	1/9		10,20
84583	17,6 x 16,2	7,5	1,0	1/6		15,50
84584	17,6 x 16,2	7,5	1,0	1/6		15,50
84586	26,5 x 16,2	7,5	1,8	1/4		23,60
84587	26,5 x 16,2	7,5	1,8	1/4		23,60
84564	53 x 16,2	7,5	3,65	2/4		31,60
84565	53 x 16,2	7,5	3,65	2/4		31,60
84589	32,5 x 26,5	7,5	4,0	1/2		32,50
84590	32,5 x 26,5	7,5	4,0	1/2		32,50

passende Deckel / suitable lid / tapa adecuada / couvercle approprié

	cm	↑ cm	fits to	€
84968	18,0 x 11,0	2,5	84555, 84556	4,00
84967	18,0 x 16,5	2,5	84583, 84584	3,80





Schale „FRIDA“

bowl
cuenco
bol

	cm	↑ cm	ltr.	Farbe / Colour	€
84592	25 x 25	12	3,5		32,50
84593	25 x 25	12	3,5		32,50

Deckel „PURE“ mit Löffelaussparung

cover with notched for spoons
tapa con espacio para la cuchara
couverture avec encoche pour la louche

	cm	↑ cm	fits to	€
83601	25 x 25	1,5	84561, 84562, 84592, 84593	10,40

mit Deckel stapelbar
stackable with cover

Schale „FRIDA“

bowl
cuenco
bol

	cm	↑ cm	ltr.	Farbe / Colour	€
84948	33,5 x 21	4	1,2		19,00

als Schütte geeignet
suitable as a chute

GN Tablett „FRIDA“

GN tray
GN bandeja
GN plateau

	cm	↑ cm	GN	Farbe / Colour	€
84985	56,0 x 35,5	1,5	1/1		39,00
84987	35,5 x 29,0	1,5	1/2		19,00

Präsentationsmöglichkeit
presentation example

passende Hauben / suitable covers / campanas adecuadas / cloches appropriées

	cm	↑ cm	GN	€
11010	53,0 x 32,5	19,0	1/1	62,00
11042	53,0 x 32,5	9,5	1/1	32,00
11021	33,0 x 28,0	17,0	1/2	29,00

mit Antirutschrinne für Hauben
with non-slip groove for covers

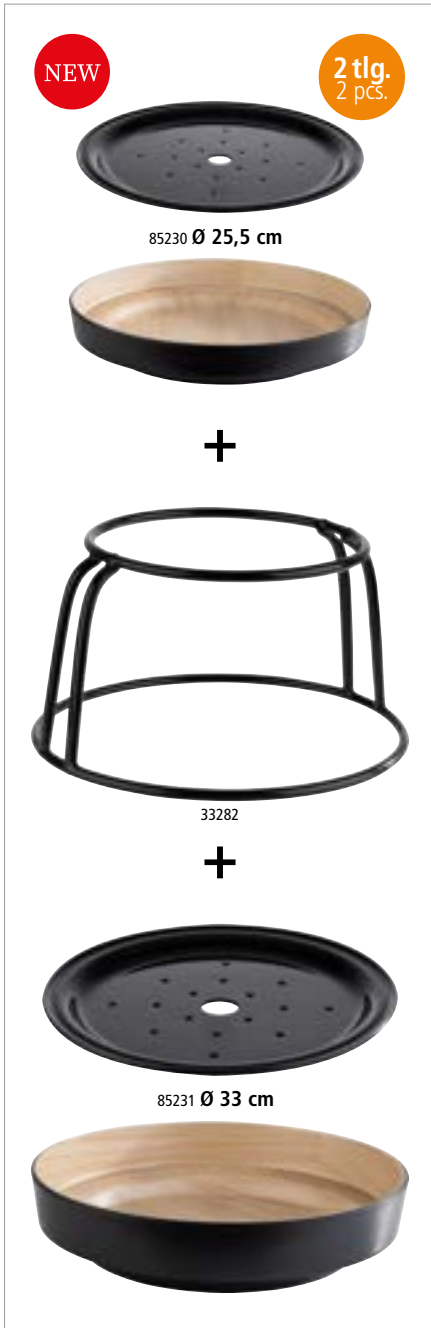

Schale, 2-teilig „FRIDA“

bowl, 2 pcs.
cuenca, set de 2
bol, set de 2

inklusive Abtropfeinsatz
including drip tray
con bandeja recoge gotas
avec égouttoir



	Ø cm	↑ cm	Farbe / Colour	€
85230	25,5	6	■ ■	27,00
85231	33,0	6	■ ■	46,00

Buffetständer

buffet stand
soporte para buffet
présentoir buffet



Metall, mit schwarzer Antirutschbeschichtung, für Schalen Nr. 85230, 85231
metal, with black anti-slip coating, for bowls no. 85230, 85231
metal, con revestimiento antideslizante negro, para cuencos 85230, 85231
métal, avec revêtement antidérapant noir, pour bols 85230, 85231

	Ø cm	↑ cm	Farbe / Colour	€
33282	23 / 30,5	17	■	42,00



Präsentationsmöglichkeit
presentation example



inklusive Abtropfeinsatz
including drip tray



3-stufige Etagère „FRIDA“

3-tier tray
bandeja con 3 alturas
étagère carré 3 hauteurs

1 Gestell aus Edelstahl, schwarz, 3 Schalen aus Melamin: Ø 20 / 25 / 32 cm
1 stainless steel frame, black, 3 melamine bowls: Ø 20 / 25 / 32 cm
1 soporte de acero inoxidable, negro, 3 cuencos de melamina: Ø 20 / 25 / 32 cm
1 support en acier inox, noir, 3 bols en mélamine: Ø 20 / 25 / 32 cm



	Ø cm	↑ cm	Farbe / Colour	€
85211	20 / 25 / 32	43	■ ■ ■	89,00

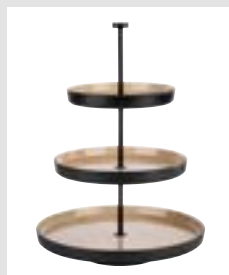

SLATE



Die schwarzen Melaminplatten überzeugen mit ihrem edlen und schlichten Schieferlook und einer rauhen Oberfläche.

The black melamine trays convince with their noble and simple slate look and a rough surface.

Las bandejas de melamina negras convencer por su aspecto de pizarra elegante y discreto y una superficie áspera.

Les plateaux en mélamine noirs convainquent grâce au aspect de l'ardoise élégant et discret et une surface rugueuse.



GN Tablett „SLATE“

GN tray
GN bandeja
GN plateau



	cm	↑ cm	GN	€
83955	53,0 x 32,5	1	1/1	47,20
83956	32,5 x 26,5	1	1/2	25,00
83957	32,5 x 17,6	1	1/3	17,30
83958	26,5 x 16,2	1	1/4	13,80
83971	53,0 x 16,2	1	2/4	27,50



GN Tablett „SLATE“

GN tray
GN bandeja
GN plateau

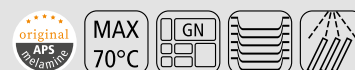

massive Metallgriffe verchromt inkl. fest verschraubten 4 cm Distanzstücken
chrome plated handles, incl. mounted 4 cm distance pillars
asas cromadas, incluye distanciadores de 4 cm firmemente montados
poignées chromées, y compris piliers de distance montées de 4 cm

	cm	↑ cm	GN	€
83980	53 x 32,5	6	1/1	56,40

SLATE



GN Tablett „SLATE“

GN tray
GN bandeja
GN plateau



	cm	↑ cm	GN	€
83981	53 x 32,5	1,5	1/1	47,40



Schieferoptik
slate look



83994

Tablett „SLATE“

tray
bandeja
plateau



	Ø cm	↑ cm	€
83992	30	1	22,60
83994	40	1	35,90



NEW

11056

85099

30336

Tablett „SLATE“

tray
bandeja
plateau

passend zu Etagère 30336

suitable for 2-tier tray 30336

adecuado para soporte 2 alturas 30336

adapté à étagère 2 niveaux



	cm	↑ cm	€
85099	28,0 x 15,5	1,0	13,00



Haube / cover / campana / cloche

	cm	↑ cm	€
11056	26,0 x 12,0	10,0	6,00



84245

83600

83601

Schale „SLATE“

bowl
cuenco
bol



	cm	↑ cm	ltr.	€
84244	19 x 19	9	1,5	21,00
84245	25 x 25	12	3,8	36,00

Deckel „PURE“ mit Löffelaussparung

cover with notched for spoons

tapa con espacio para la cuchara

couvercle avec encoche pour la louche

	cm	↑ cm	fits to	€
83600	19 x 19	1,5	84244	8,20
83601	25 x 25	1,5	84245	10,40

SLATE ROCK



84258

84259

84257



84258

84259

84257

Tablett „SLATE-ROCK“

tray
bandeja
plateau



Die schwarzen Melaminplatten überzeugen mit ihrem Schieferlook

The black melamine trays convince with their slate look

Las bandejas de melamina negras convencen por su aspecto de pizarra

Les plateaux en mélamine noirs convainquent grâce au aspect de l'ardoise

	cm	↑ cm	Griff / handle cm	€
84258	40 x 20	1,5	13	29,90
84259	48 x 20	1,5	13	35,90
	Ø cm	↑ cm	Griff / handle cm	€
84257	30	1,5	12	24,20



7 tlg.
7 pcs.

Serving-Box

serving box
caja comida
boîte-repas



7 teiliges Set:

- 1 Box + 1 Deckel
- 1 Schale groß (23 x 14 x 6 cm, 1,4 ltr.)
- 1 Schale mittel (14 x 11,5 x 6 cm, 0,6 ltr.)
- 2 Schalen klein (11,5 x 7 x 6 cm, 0,25 ltr.)
- 1 Antirutsch-Matte (26 x 21 cm)

7 pcs.:

- 1 box + 1 cover
- 1 bowl large (23 x 14 x 6 cm, 1,4 ltr.)
- 1 bowl medium (14 x 11,5 x 6 cm, 0,6 ltr.)
- 2 bowls small (11,5 x 7 x 6 cm, 0,25 ltr.)
- 1 non-slip mat (26 x 21 cm)

set de 7:

- 1 caja + 1 tapa
- 1 cuenco, grande (23 x 14 x 6 cm, 1,4 ltr.)
- 1 cuenco mediano (14 x 11,5 x 6 cm, 0,6 ltr.)
- 2 cuencos pequeños (11,5 x 7 x 6 cm, 0,25 ltr.)
- 1 esterilla antideslizante (26 x 21 cm)

set de 7:

- 1 boîte + 1 couvercle
- 1 bol, grand (23 x 14 x 6 cm, 1,4 ltr.)
- 1 bol moyen (14 x 11,5 x 6 cm, 0,6 ltr.)
- 2 bols petits (11,5 x 7 x 6 cm, 0,25 ltr.)
- 1 tapis antidérapant (26 x 21 cm)

	Ø cm	↑ cm	Farbe / colour	€
85088	30 x 25	8	■	44,00



stapelbar
stackable

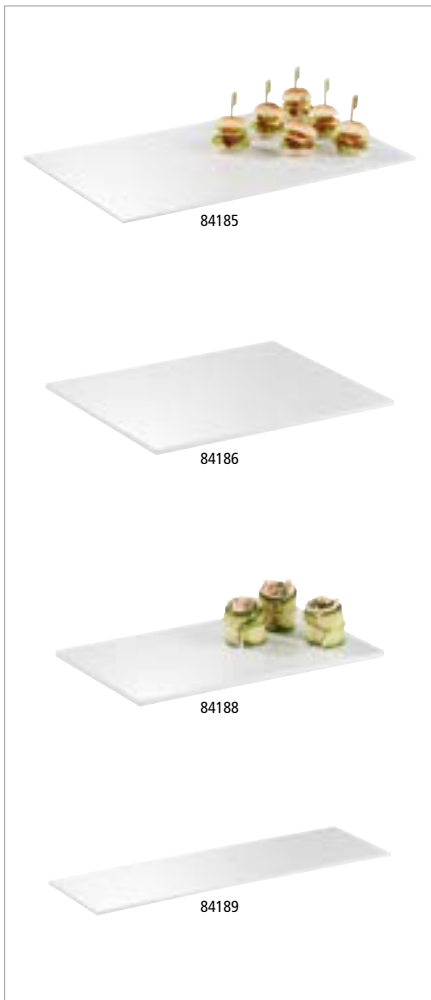

GN Tablett „ZERO“

GN tray
GN bandeja
GN plateau

glatte, hochglänzende Oberfläche
smooth and shiny surface
superficie lisa con acabado brillante
surface lisse et finition brillante



	cm	↑ cm	GN	Farbe / Colour	€
84185	53,0 x 32,5	1,5	1/1		41,40
84186	32,5 x 26,5	1,5	1/2		22,40
84187	32,5 x 17,6	1,5	1/3		15,60
84188	26,5 x 16,2	1,5	1/4		12,60
84189	53,0 x 16,2	1,5	2/4		24,60

passende Hauben / suitable covers / campanas adecuadas / cloches appropriées

	cm	↑ cm	* mm	GN	€
11042	53,0 x 32,5	9,5	3	1/1	32,00
11041	32,5 x 26,5	9,5	3	1/2	23,00
11043	32,5 x 17,6	10,5	3	1/3	17,00
11044	53,0 x 16,2	10,5	3	2/4	23,00



mit Antirutschfüßchen
with non-slip feet



GN Tablett „DRIFTWOOD“

GN tray
GN bandeja
GN plateau

die Melaminplatten (Holzoptik) haben eine leicht wellige Oberfläche und wirken optisch wie aus Holz gefertigt

the melamine trays (wood look) have a slightly wavy surface and look visually as made of natural wood

las bandejas de melamina (imitación madera) tienen una superficie ligeramente ondulada y parecen estar hechas de madera natural

les plateaux de mélamine (imitation bois) ont une surface légèrement ondulée et donnent une impression visuelle de bois naturelle



	cm	↑ cm	GN	€
84180	53,0 x 32,5	1,5	1/1	43,70
84181	32,5 x 26,5	1,5	1/2	22,40
84182	32,5 x 17,6	1,5	1/3	15,60



CIRCLE



Tablett „CIRCLE“
plate / tray
plato / bandeja
assiette / plateau



	Ø cm	↑ cm	Farbe / Colour	€
84875	32,0	3,5		31,00
84876	40,5	5,5		45,00

LA VIDA



Tablett „LA VIDA“
plate / tray
plato / bandeja
assiette / plateau



	Ø cm	↑ cm	Farbe / Colour	€
84161	32,0	3,5		33,40
84170	40,5	5,5		48,30
	Ø cm	↑ cm	Farbe / Colour	€
84171	32,0	3,5		33,40
84172	40,5	5,5		48,30



MARONE

Eine derbe Oberflächenstruktur schafft ein natürliches Erscheinungsbild.

Die schwarzen Schalenvarianten mit braunem Rand inszenieren Ihr Gericht sehr stilvoll.

A rough surface structure creates a natural appearance.

The black bowls and trays with brown border stage your dishes in a very stylish way.

La estructura rugosa de la superficie crea una apariencia natural.

Los diferentes cuencos negros con borde marrón ponen con mucho estilo en escena sus platos.

La structure de surface rugueuse crée une apparence naturelle.

Les différents bols noirs avec rebord marron mettent élégamment en scène vos plats.



84100 0,4 ltr.

84101 0,9 ltr.

Blattschale „MARONE“ leaf fuente en forma de hoja plateau feuille



	cm	↑ cm	ltr.	€
84100	25,5 x 14	5,5	0,4	9,80
84101	36,0 x 19	8,0	0,9	15,00



84731 0,25 ltr.

84732 0,6 ltr.

84733 1,4 ltr.

Schale „MARONE“ bowl cuenco bol



	cm	↑ cm	ltr.	€
84731	16,5 x 10	5,5	0,25	12,00
84732	22,0 x 13	7,5	0,6	14,40
84733	27,5 x 19	9,0	1,4	17,20



Oberflächenansicht
surface view



84107 0,05 ltr.



84108 0,04 ltr.

Schale „MARONE“

bowl
cuenco
bol



	Ø cm	↑ cm	ltr.	€
84107	8,5	2,5	0,05	6,50
84108	11,5	3,0	0,04	6,90



84115 0,2 ltr.



84116 0,2 ltr.

Schale „MARONE“

bowl
cuenco
bol



	Ø cm	↑ cm	ltr.	€
84115	11	3,5	0,13	6,50
84116	14	4,0	0,20	7,20



84109 0,2 ltr.

Schale „MARONE“

bowl
cuenco
bol



	Ø cm	↑ cm	ltr.	€
84109	11	5,5	0,2	6,70



84111 0,8 ltr.

Schale „MARONE“

bowl
cuenco
bol



	Ø cm	↑ cm	ltr.	€
84110	14	6,0	0,30	7,80
84111	19	8,0	0,80	14,00
84112	21	8,5	1,00	14,50
84113	24	9,5	1,40	17,00



84174 2,0 ltr.

Schale „MARONE“

bowl
cuenco
bol



	Ø cm	↑ cm	ltr.	€
84174	30,5	8,5	2	24,70

MARONE

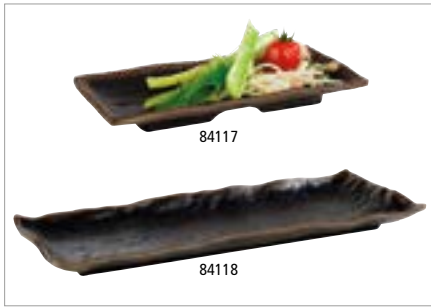

Tablett „MARONE“

tray
bandeja
plateau



MAX
70°C



	cm	↑ cm	€
84117	19,5 x 9,5	2	10,00
84118	39,0 x 16,0	3	19,80



Tablett „MARONE“

tray
bandeja
plateau



MAX
70°C



	cm	↑ cm	€
84119	32,5 x 23,5	4,5	19,80



Tablett „MARONE“

tray
bandeja
plateau



MAX
70°C



	cm	↑ cm	€
84104	22,5 x 15	3	12,00
84105	27,5 x 11	2	12,00



Tablett „MARONE“

tray
bandeja
plateau



MAX
70°C



	cm	↑ cm	€
84103	14,5 x 14,5	2	6,50



Tablett „MARONE“

tray
bandeja
plateau



MAX
70°C



	cm	↑ cm	€
84106	26,5 x 16,5	4	13,80



Teller „MARONE“

plate
plato
assiette



MAX
70°C



	Ø cm	↑ cm	€
84728	16,0	2,5	8,00
84729	20,5	2,5	8,70
84730	28,0	3,5	10,70

DARK WAVE



GN Tablett „DARK WAVE“

GN tray
GN bandeja
GN plateau



	cm	↑ cm	GN	€
84900	53,0 x 32,5	2	1/1	46,50
84901	32,5 x 26,5	2	1/2	23,70
84902	32,5 x 17,6	2	1/3	14,30
84903	53,0 x 16,2	2	2/4	22,80



mit Antirutschfüßchen
with non-slip feet

DARK WAVE



Tablett „DARK WAVE“

tray
bandeja
plateau



	cm	↑ cm	€
84904	14 x 14	2	5,30



Tablett „DARK WAVE“

tray
bandeja
plateau



	cm	↑ cm	€
84905	23 x 10,5	1,5	7,40
84906	29 x 12,0	1,5	9,70



Teller „DARK WAVE“

plate
plato
assiette



	Ø cm	↑ cm	€
84907	14,5	1,5	4,00
84908	22,0	2,0	8,00
84909	27,0	2,5	12,00



Schale „DARK WAVE“

bowl
cuenco
bol



	Ø cm	↑ cm	litr.	€
84910	17,5	5,0	0,50	9,00
84911	22,5	5,0	0,75	11,80
84912	32,0	3,5	–	19,40

ZEN



Fernöstliche Tisch- und Buffetartikel präsentiert die Serie ZEN. Die Optik entspricht dem japanischen Steingut.

The ZEN series presents Far Eastern table and buffet articles. The appearance is that of Japanese stoneware.

La colección ZEN presenta artículos de buffet y mesa para la cocina oriental. Su aspecto recuerda al gres japonés.

La collection ZEN présente des articles de buffet et de table pour la cuisine orientale. L'aspect de la mélamine rappelle le grès japonais.



Schale „ZEN“

bowl
cuenco
bol



MAX
70°C



	Ø cm	↑ cm	ltr	Farbe / Colour	€
83929	31	8,5	2,5	■	27,10



Schale „ZEN“

bowl
cuenco
bol



MAX
70°C



	Ø cm	↑ cm	ltr	Farbe / Colour	€
84355	22,5	12,5	0,80	■	12,50



Schale „ZEN“

bowl
cuenco
bol



MAX
70°C



	cm	↑ cm	ltr	Farbe / Colour	€
83712	21 x 21	11	1,40	■	13,60



Schale „ZEN“

bowl
cuenco
bol

	Ø cm	↑ cm	ltr.	Farbe / Colour	€
84348	10,0	7,0	0,08	■	3,50
84349	10,0	7,0	0,08	■	3,50
84351	12,5	8,5	0,15	■	5,20
84353	16,0	10,0	0,30	■	8,30

stapelbar
stackable

Schale „ZEN“

bowl
cuenco
bol

	cm	↑ cm	ltr.	Farbe / Colour	€
83735	25,0 x 13,5	4	0,25	■	5,20
83739	30,5 x 17,5	5	0,60	■	10,30



Schale „ZEN“

bowl
cuenco
bol

	cm	↑ cm	ltr.	Farbe / Colour	€
83716	17,5 x 17,5	7	0,5	■	8,00



Schale „ZEN“

bowl
cuenco
bol

	cm	↑ cm	ltr.	Farbe / Colour	€
83725	10,5 x 10,5	3	0,06	■	3,00
83727	10,5 x 10,5	3	0,06	■	3,00



Dipschälchen „ZEN“

dip bowl
cuenco para dip
bol para dip

	Ø cm	↑ cm	ltr.	Farbe / Colour	€
83721	8	1,5	0,03	■	1,30
83723	8	1,5	0,03	■	1,30



Schale „ZEN“

bowl
cuenco
bol

	cm	↑ cm	ltr.	Farbe / Colour	€
83718	12 x 12	4	0,2		5,50
83720	12 x 12	4	0,2		5,50



Schale „ZEN“

bowl
cuenco
bol

	cm	↑ cm	ltr.	Farbe / Colour	€
83726	13 x 11	3,5	0,1		3,20
83728	13 x 11	3,5	0,1		3,20



Schale „ZEN“

bowl
cuenco
bol

	cm	↑ cm	ltr.	Farbe / Colour	€
83730	11 x 10	3	0,04		2,80
83732	11 x 10	3	0,04		2,80



Schale „ZEN“

bowl
cuenco
bol

	cm	↑ cm	ltr.	Farbe / Colour	€
83722	17,5 x 15,5	5,5	0,2		7,40
83724	17,5 x 15,5	5,5	0,2		7,40



Schale „ZEN“

bowl
cuenco
bol

	cm	↑ cm	ltr.	Farbe / Colour	€
83935	14,5 x 12,5	5	0,2		5,60



Schale „ZEN“

bowl
cuenco
bol

	Ø cm	↑ cm	ltr.	Farbe / Colour	€
83932	11,5	4	0,15		5,30
83933	11,5	4	0,15		5,30



Schale „ZEN“

bowl
cuenco
bol

	cm	↑ cm	ltr.	Farbe / Colour	€
83946	9 x 7	2,5	0,05	■	4,00
83947	9 x 7	2,5	0,05	■	4,00



Schale „ZEN“

bowl
cuenco
bol

	cm	↑ cm	Farbe / Colour	€
83949	14 x 9	2,5	■	4,50



Tablett / Teller „ZEN“

tray / plate
bandeja / plato
plateau / assiette

	Ø cm	↑ cm	Farbe / Colour	€
83941	28	3	■	11,50



Tablett / Sushiboard „ZEN“

tray / sushiboard
bandeja para sushi
plateau sushi

	cm	↑ cm	Farbe / Colour	€
83742	22,5 x 9,5	3	■	5,00
83744	22,5 x 9,5	3	■	5,00



Tablett / Sushiboard „ZEN“

tray / sushiboard
bandeja para sushi
plateau sushi

	cm	↑ cm	Farbe / Colour	€
83740	22 x 12	3	■	6,80



Charakterstark und mit dem Anspruch an Funktionalität und Design präsentiert sich die Buffetserie SINUS. Die großzügigen Flächen für die Speisenpräsentation sind ausdrucksstark eingefasst und gewährleisten ein optimales Handling.

The SINUS buffet series is characterful and with a high standard of functionality and design. The spacious areas for the food presentation are expressively enclosed and ensure optimal handling in everyday dining.

La serie de buffet SINUS demuestra un caracter fuerte y tiene un alto nivel de funcionalidad y diseño. Las áreas espaciaosas para la presentación de la comida son expresivamente enmarcadas y aseguran un manejo óptimo en la gastronomía.

La série de buffet SINUS est pleine de caractère et avec un haut niveau de fonctionnalité et de design. Les zones spacieuses pour la présentation de la nourriture sont expressivement encadré et assurent une maniabilité optimale dans la restauration.



GN Tablett „SINUS“
 GN tray
 GN bandeja
 GN plateau

original APS melamine MAX 70°C

	cm	↑ cm	GN	Farbe / Colour	€
84230	53 x 32,5	2	1/1	White	33,40
84231	53 x 16,2	2	2/4	White	20,30



Schale „SINUS“
 bowl
 cuenco
 bol

original APS melamine MAX 70°C

	cm	↑ cm	litr.	€
84232	21,0 x 21,0	9,0	1,5	20,30
84233	25,0 x 25,0	11,0	2,4	26,50

HALFTONE



Fingerfood Löffel „HALFTONE“

party spoon
cuchara party
cuillère party



	∅ cm	↑ cm	Farbe / Colour	VE / unit	€ / pc.
84158	5,5	7	■ □	24	3,70



Fingerfood Löffel „HALFTONE“

party spoon
cuchara party
cuillère party



	cm	↑ cm	Farbe / Colour	VE / unit	€ / pc.
84128	14,5 x 4,5	4,5	■ □	12	3,70



Tablett „HALFTONE“

tray
bandeja
plateau



	cm	↑ cm	€
84125	24,5 x 15,0	3	8,70



Tablett „HALFTONE“

tray
bandeja
plateau



	cm	↑ cm	€
84126	29 x 18	4	11,00

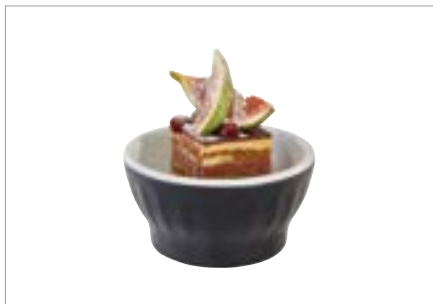

Schale „HALFTONE“

bowl
cuenco
bol



	Ø cm	↑ cm	ltr.	VE / unit	€ / pc.
84217	8	4	0,1	12	4,00



Schale „HALFTONE“

bowl
cuenco
bol



	cm	↑ cm	ltr.	€
84130	11,5 x 7,0	4,0	0,05	3,40
84131	14,0 x 8,0	4,5	0,10	4,30
84132	15,0 x 9,5	5,0	0,15	4,90
84133	17,5 x 13,5	6,5	0,35	7,20
84134	24,0 x 17,5	7,5	0,8	12,90



Schale „HALFTONE“

bowl
cuenco
bol



	Ø cm	↑ cm	ltr.	€
84135	16,5	7,5	0,65	10,20

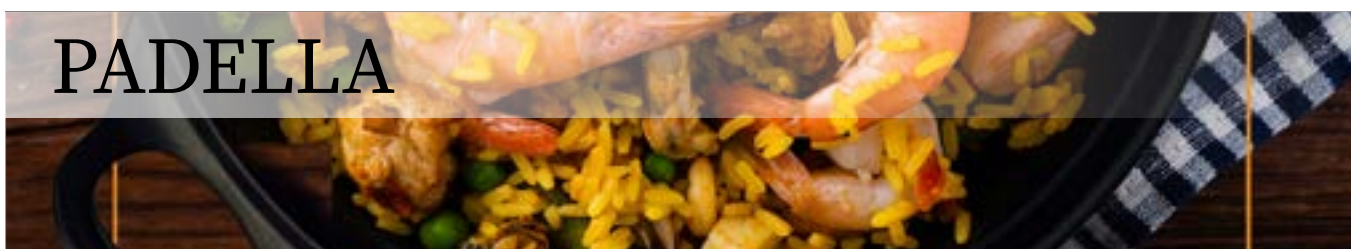

PADELLA



Schale „PADELLA“

bowl
cazuelita
plat 2 anses „cocotte“



	Ø cm	↑ cm	ltr.	Griff / handle cm	€
85150	21	9	1,5	5 x 3,5	15,40
85151	28	9	3,0	5 x 3,5	23,00

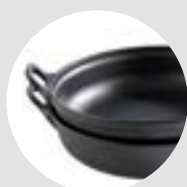

stapelbar und rutschfest
stackable and nonslip

APART



GN Tablett „APART“

GN tray
GN bandeja
GN plateau



MAX
70°C



	cm	↑ cm	GN	€
83828	53,0 x 32,5	2,5	1/1	38,50
83830	32,5 x 26,5	2,5	1/2	21,40



Dipschälchen „APART“

dip bowl
cuenco para dip
ramequin



MAX
70°C



	Ø cm	↑ cm	ltr.	€
83800	6,5	3,0	0,045	1,70



Dipschälchen „APART“

dip bowl
cuenco para dip
ramequin



MAX
70°C



	cm	↑ cm	ltr.	€
83808	6,5 x 6,5	3,0	0,05	1,80

CASCADE



Schale „CASCADE“

bowl
cuenco
bol



MAX
70°C



	cm	↑ cm	GN	ltr.	€
83960	32,5 x 26,5	7,5	1/2	3,65	22,40
83962	26,5 x 16,2	7,5	1/4	1,50	12,70
83961	53 x 16,2	7,5	2/4	3,65	24,20



Außenmaße Gastronorm
size Gastronorm

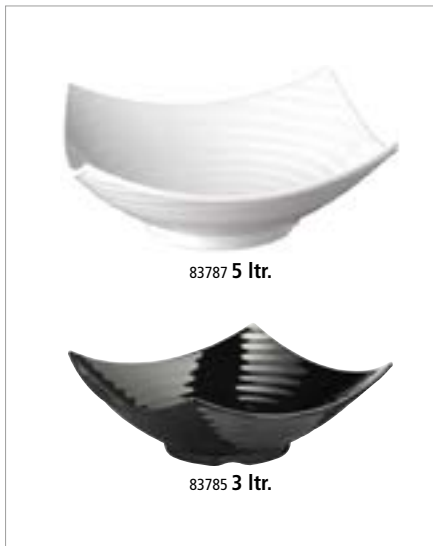

Schale „GLOBAL BUFFET“

bowl
cuenco
bol



	cm	↑ cm	ltr.	Farbe / Colour	€
83785	32,5 x 32,5	12,0	3,0		25,90
83787	40,0 x 40,0	13,5	5,0		41,90
84785	32,5 x 32,5	12,0	3,0		25,90



Schale „GLOBAL BUFFET“

bowl
cuenco
bol



	cm	↑ cm	ltr.	Farbe / Colour	€
84464	35,5 x 31,5	14,0	2,5		20,20
84466	46,0 x 40,0	18,5	5,5		36,60



Schale „GLOBAL BUFFET“

bowl
cuenco
bol



	cm	↑ cm	ltr.	Farbe / Colour	€
83799	25,5 x 25,5	13,0	3,0		21,00
83788	32,0 x 32,0	16,5	4,5		26,40
83789	35,0 x 35,0	17,0	6,0		32,70
83790	40,0 x 40,0	17,5	8,0		41,90



Schale „GLOBAL BUFFET“

bowl
cuenco
bol



	cm	↑ cm	ltr.	Farbe / Colour	€
84462	44 x 25	20	3,3		24,20



Schale „LEAF“

bowl
cuenco
bol



	cm	↑ cm	ltr.	Farbe / Colour	€
84200	42 x 19,5	6,5	1,0		13,50
84202	50 x 23,0	7,5	1,5		20,60

FLYING BUFFET



Fingerfood-Teller „FLYING BUFFET“

fingerfood plate
plato para el aperitivo
assiette pour apéritif



	cm	↑ cm	Farbe / Colour	€
83878	9,5 x 9,5	1,5 / 3,5	White	4,00
83879	9,5 x 9,5	1,5 / 3,5	Black	4,00



Schale „FLOAT“

bowl
cuenco
bol



	cm	↑ cm	Farbe / Colour	€
83912	9 x 9	4,5	White	3,70
83913	9 x 9	4,5	Black	3,70



GN Tablett „APART“

GN tray
GN bandeja
GN plateau



	cm	↑ cm	GN	€
83828	53 x 32,5	2,5	1/1	38,50
83830	32,5 x 26,5	2,5	1/2	21,40



GN Edelstahl Tablett

GN stainless steel platter
GN bandeja de acero inoxidable
GN plateau en acier inox



	cm	GN	€
11119	53 x 32,5	1/1	33,00



FLOAT



- Ideal für den Thekenbereich
- stapelbar mit Löffel und Deckel
- Schalenboden fixiert sich auf dem Deckel
- rutschfest (Antirutschfüßchen)

- ideal for the counter area
- stackable with spoon and lid
- the bottom of the bowl is fixed on the lid
- non-slip (with non-slip feet)

- ideal para la zona del mostrador
- apilable con cuchara y tapa
- el fondo del cuenco se fija en la tapa
- antideslizante (con pies antideslizantes)

- idéal pour l'aire de comptoir
- empilable avec cuillère et couvercle
- le fond du bol se fixe sur le couvercle
- antidérapant (avec pieds antidérapants)



Schale „FLOAT“ bowl cuenco bol



	Ø cm	↑ cm	ltr.	Farbe / Colour	€
83900	5,5	3,0	0,03		1,90
83902	9,0	4,5	0,15		3,30
83904	13,0	6,5	0,45		7,60
83906	15,0	7,5	0,70		11,30
83908	20,5	10,0	1,90		18,90
83901	5,5	3,0	0,03		1,90
83903	9,0	4,5	0,15		3,30
83905	13,0	6,5	0,45		7,60
83907	15,0	7,5	0,70		11,30
83909	20,5	10,0	1,90		18,90

FLOAT



Schale „FLOAT“

bowl
cuenco
bol



	cm	↑ cm	ltr.	Farbe / Colour	€
83910	5,5 x 5,5	3,0	0,03	White	1,90
83912	9,0 x 9,0	4,5	0,16	White	3,70
83914	12,5 x 12,5	6,0	0,50	White	7,20
83916	19,0 x 19,0	9,5	1,90	White	17,00
83918	25,0 x 25,0	12,0	4,70	White	31,00
83911	5,5 x 5,5	3,0	0,03	Black	1,90
83913	9,0 x 9,0	4,5	0,16	Black	3,70
83915	12,5 x 12,5	6,0	0,50	Black	7,20
83917	19,0 x 19,0	9,5	1,90	Black	17,00
83919	25,0 x 25,0	12,0	4,70	Black	31,00



stapelbar
stackable



GN Tablett „FLOAT“

GN tray
GN bandeja
GN plateau



	cm	↑ cm	GN	Farbe / Colour	€
83923	53,0 x 32,5	3	1/1	White	39,00
83925	32,5 x 26,5	3	1/2	White	23,70
83924	53,0 x 32,5	3	1/1	Black	39,00
83926	32,5 x 26,5	3	1/2	Black	23,70



Deckel „FLOAT“ mit Löffelaussparung

cover with notched for spoons
tapa con espacio para la cuchara
couverture avec encoche pour la louche



	cm	↑ cm	fits to	€
83920	Ø 20,5	1,3	83908, 83909	9,20
83921	19 x 19	1,3	83916, 83917	8,40
83922	25 x 25	1,3	83918, 83919	10,60

PURE



Tablett „PURE“

tray
bandeja
plateau

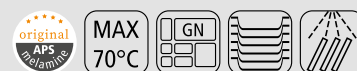

	cm	↑ cm	GN	Farbe / Colour	€
83401	53,0 x 32,5	3	1/1		42,00
83433	53,0 x 16,2	3	2/4		25,00
83480	32,5 x 26,5	3	1/2		22,60
83481	32,5 x 17,6	3	1/3		17,00
83482	26,5 x 16,2	3	1/4		12,40
83597	40,0 x 30,0	3	Bäcker-Maß		32,00

	cm	↑ cm	GN	Farbe / Colour	€
83479	53,0 x 32,5	3	1/1		42,00
83434	53,0 x 16,2	3	2/4		24,00
83490	32,5 x 26,5	3	1/2		22,00
83491	32,5 x 17,6	3	1/3		17,00
83492	26,5 x 16,2	3	1/4		12,40
83592	40,0 x 30,0	3	Bäcker-Maß		32,00



Tablett „PURE“

tray
bandeja
plateau



	cm	↑ cm	Farbe / Colour	€
83403	35,5 x 18,0	3		14,00
83417	30,0 x 21,0	3		16,40
83402	53,0 x 18,0	3		28,00



Tablett quadratisch „PURE“

tray square
bandeja cuadrada
plateau carré



	cm	↑ cm	Farbe / Colour	€
83418	18,0 x 18,0	3		8,20
83407	21,0 x 21,0	3		11,80
83406	26,5 x 26,5	3		17,90
83405	37,0 x 37,0	3		24,40
83404	51,0 x 51,0	3		51,00



Tablett / Teller „PURE“

tray / plate
bandeja / plato
plateau / assiette



	Ø cm	↑ cm	Farbe / Colour	€
83884	31	2,5		21,60
83869	38	2,5		24,70
83484	51	2,5		33,40



Teller, rund „CASUAL“

plate, round
plato, redondo
assiette, ronde



	Ø cm	↑ cm	€
83500	22,5	2,5	8,60
83514	26,5	2,5	10,30



Schale „PURE“

bowl
cuenco
bol



	Ø cm	↑ cm	ltr.	Farbe / Colour	€
83450	5,5	4,0	0,02		2,00
83419	9,0	4,5	0,09		3,60
83453	13,0	6,5	0,30		7,60
83455	15,0	7,5	0,45		12,00
83415	20,0	10,5	1,25		21,60

	Ø cm	↑ cm	ltr.	Farbe / Colour	€
83451	5,5	4,0	0,02		2,00
83452	9,0	4,5	0,09		3,60
83454	13,0	6,5	0,30		7,60



Schale „PURE“

bowl
cuenco
bol



	cm	↑ cm	ltr.	Farbe / Colour	€
84424	6,5 x 6,5	3,0	0,05		2,60
83414	9,0 x 9,0	4,0	0,14		4,20
83410	12,5 x 12,5	6,5	0,40		6,80
83409	19,0 x 19,0	9,0	1,50		22,40
83408	25,0 x 25,0	12,0	3,80		36,70
84425	32,0 x 32,0	14,0	8,0		44,80

	cm	↑ cm	ltr.	Farbe / Colour	€
84426	6,5 x 6,5	3,0	0,05		2,60
83466	9,0 x 9,0	4,0	0,14		4,20
83467	12,5 x 12,5	6,5	0,40		6,80
83468	19,0 x 19,0	9,0	1,50		22,40
83469	25,0 x 25,0	12,0	3,80		36,70
84427	32,0 x 32,0	14,0	8,0		44,80



Schale „PURE COLOR“

bowl
cuenco
bol



	cm	↑ cm	ltr.	Farbe / Colour	€
85260	19 x 19	9	1,5	sand	22,40
85261	25 x 25	12	3,8	sand	36,70
85266	19 x 19	9	1,5	olive	22,40
85267	25 x 25	12	3,8	olive	36,70



Schale „SLATE“

bowl
cuenco
bol



	cm	↑ cm	ltr.	€
84244	19 x 19	9	1,5	21,00
84245	25 x 25	12	3,8	36,00

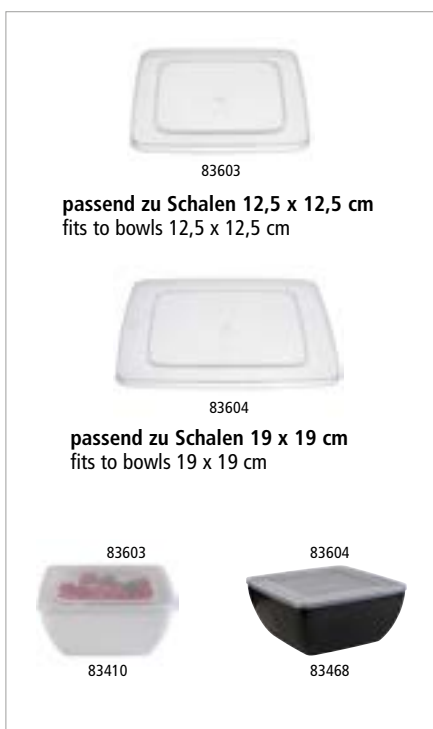

Deckel „PURE“, 5er Set

cover, 5 pcs.
tapa, set de 5
couvercle, set de 5



Hygienischer Schutz für Ihre Speisen

- dichtschießend
- schwappsicherer Transport

protection for your food

- tightly closing
- slosh-proof transport

protección de alimentos

- con cierre hermético
- transporte sin salpicaduras

protection des aliments

- fermeture hermétique
- transport sans éclaboussures

	cm	↑ cm	pcs.	fits to	€ / set
83603	13,0 x 13,0	0,5	5	83410, 83467	6,00
83604	19,5 x 19,5	0,5	5	83409, 83468, 84244, 84830, 85261, 85267, 79004, 79005	7,00



Deckel „PURE“ mit Löffelaussparung
 cover with notched for spoons
 tapa con espacio para la cuchara
 couvercle avec encoche pour la louche



	cm	↑ cm	fits to	€
83600	19 x 19	1,5	84409, 84417, 84422, 83409, 83468, 83572, 83573	8,20
83601	25 x 25	1,5	84408, 84418, 84423, 84430, 83575, 83574, 83469, 83408	10,40



mit Deckel stapelbar
 stackable with cover



Schale „PURE“
 bowl
 cuenco
 bol



	cm	↑ cm	litr.	€
83498	38,5 x 15,5	7,5	1,50	34,00
83499	51,0 x 15,5	7,5	2,40	44,90



Tablett
 tray
 bandeja
 plateau



Edelstahl matt poliert, passend für 2 Melamin-Schalen
 stainless steel matt polished, for 2 melamine bowls
 acero inoxidable pulido mate, para 2 cuencos de melamina
 acier inox poli mat, pour 2 bols de mélamine

	cm	€
30120	20 x 11	8,00

Edelstahl matt poliert, passend für 6 Melamin-Schalen
 stainless steel matt polished, for 6 melamine bowls
 acero inoxidable pulido mate, para 6 cuencos de melamina
 acier inox poli mat, pour 6 bols de mélamine

	cm	€
30121	29 x 20	16,40

Schale „PURE COLOR“ / bowl / cuenco / bol

	cm	↑ cm	litr.	Farbe / Colour	€
83414	9 x 9	4	0,14	White	4,20
83466	9 x 9	4	0,14	Black	4,20



GN Tablett „FRAMES“
 GN tray
 GN bandeja
 GN plateau



	cm	↑ cm	GN	€
84046	53,0 x 32,5	2	1/1	33,00
84047	32,5 x 26,5	2	1/2	18,40
84048	32,5 x 17,6	2	1/3	12,60

ENAMEL LOOK



Teller „ENAMEL LOOK“

plate
plato
assiette



	Ø cm	↑ cm	Farbe / Colour	€
84950	20,5	2,0		6,30
84951	24,5	2,5		8,30



Schale „ENAMEL LOOK“

bowl
cuenco
bol



	cm	↑ cm	ltr.	Farbe / Colour	€
84958	15,0 x 11,5	6,5	0,30		3,70
84959	21,5 x 16,5	9,5	1,00		8,30



Schale „ENAMEL LOOK“

bowl
cuenco
bol



	Ø cm	↑ cm	ltr.	Farbe / Colour	€
84490	5,5	4,0	0,02		2,20
84491	9,5	4,5	0,09		3,70
84492	13,0	6,5	0,30		8,00

CASUAL



Schälchen „CASUAL MINI“

bowl
cuenco
bol mini



	cm	↑ cm	ltr.	Farbe / Colour	€
83880	6,0	2,5	0,02	White	2,10
83881	7,5	3,5	0,05	White	2,60



Schale „CASUAL MAXI“

bowl
cuenco
bol



	Ø cm	↑ cm	ltr.	Farbe / Colour	€
83696	10	4,5	0,15	White	3,50
83698	12	5,5	0,25	White	4,20
83700	14	6,5	0,50	White	4,90
83704	20	9,2	1,80	White	10,40
83702	23	10,5	2,50	White	11,80

	Ø cm	↑ cm	ltr.	Farbe / Colour	€
83697	10	4,5	0,15	Black	3,50
83699	12	5,5	0,25	Black	4,20
83701	14	6,5	0,50	Black	4,90
83705	20	9,2	1,80	Black	10,40
83703	23	10,5	2,50	Black	11,80

Deckel „FLOAT“ mit Löffelaussparung / cover with notched for spoons / tapa con espacio para la cuchara / couvercle avec encoche pour la louche

	Ø cm	↑ cm	fits to	€
83920	20,5	1,3	83704, 83705	9,20



Schale „CASUAL“

bowl
cuenco
bol



	cm	↑ cm	ltr.	€
84221	26,5 x 10,5	6,5	1,0	11,80



83605 Ø 8 cm

passend zu Schalen Ø 7,5 cm
fits to bowls Ø 7,5 cm



83606 Ø 14,5 cm

passend zu Schalen Ø 14 cm
fits to bowls Ø 14 cm



83607 Ø 20,5 cm

passend zu Schalen Ø 20 cm
fits to bowls Ø 20 cm

Deckel „CASUAL“, 5er Set

cover, 5 pcs.

tapa, set de 5

couvercle, set de 5

Hygienischer Schutz für Ihre Speisen

dichtschließend, schwappsicherer Transport

protection for your food

tightly closing, slosh-proof transport

protección de alimentos, con cierre hermético, transporte sin salpicaduras

protection des aliments

fermeture hermétique, transport sans éclaboussures



	Ø cm	↑ cm	fits to	pcs.	€/ set
83605	8,0	0,5	11866, 83881, 15400, 15416, 15461, 15462, 15467, 40655, 40656	5	3,60
83606	14,5	0,5	11865, 83700, 83701, 85104, 85105, 85107	5	6,00
83607	20,5	0,5	83704, 83705, 15404, 15420	5	7,00

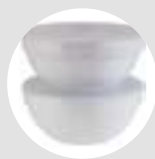

stapelbar
stackable



84215



84216

Schale „CASUAL“

bowl

cuenco

bol



	Ø cm	↑ cm	ltr.	Farbe / Colour	€
84215	10	6,5 / 8,5	0,2	—	5,90
84216	12	7,5 / 9,5	0,3	—	7,50



Schale „CASUAL“

bowl

cuenco

bol



	Ø cm	↑ cm	ltr.	Farbe / Colour	€
84295	10	7	0,13	—	3,40



Dipschale „CASUAL“

dip tray

bandeja para dips

plateau pour dips



	cm	↑ cm	Farbe / Colour	€
84220	29 x 9	3	—	8,00



83780



83798



83777

Dipschälchen „CASUAL“

dip bowl

cuenco para dip

ramequin



	Ø cm	↑ cm	ltr.	Farbe / Colour	VE / unit	€/ pc.
83780	6,0	4,0	0,05	—	24	1,20
83781	7,5	4,0	0,07	—	24	1,50
83782	8,0	4,5	0,08	—	24	1,90
83783	8,5	4,5	0,12	—	24	2,00
83798	6,0	4,0	0,05	—	24	1,40
83777	6,0	3,5	0,04	—	24	1,40

NATURAL COLLECTION



Blattschale „NATURAL COLLECTION“ leaf fuente en forma de hoja plateau feuille



	cm	↑ cm	Farbe / Colour	€
83438	45 x 24	3,0		19,50
83441	53 x 29	3,5		22,90

	cm	↑ cm	Farbe / Colour	€
83437	36 x 16	3,0		14,50
83440	45 x 24	3,0		19,50
83443	53 x 29	3,5		22,90



Fass, 2-teilig bowl cuenco bol



2-teilig: Unterteil / Schale, Edelstahlschale
2 pcs.: lower part / bowl, stainless steel bowl
set de 2: parte inferior / cuenco, cuenco de acero inoxidable
set de 2: partie inférieure / bol, bol en acier inox

	Ø cm	↑ cm	€
85250	26	16	49,00

Unterteil / Unterteil / Unterteil / Unterteil

	Ø cm	↑ cm	ltr.	€
85251	25	16	4,5	38,00

Edelstahlschale / Edelstahlschale / Edelstahlschale / Edelstahlschale

	Ø cm	↑ cm	ltr.	€
85252	26	9	3,0	12,00

passender Deckel mit Löffelaussparung / suitable cover with notched for spoons / tapa adecuada con espacio para la cuchara / couvercle appropriée avec encoche pour la louche

	Ø cm	↑ cm	€
83920	20,5	1,3	9,20



Unterteil mit Eis füllen für perfekte Kühlung sensibler Speisen
fill the bottom part with ice for perfect cooling of sensitive dishes

BRÖTCHENSCHÜTTE



85140



85140



85141



85141

Tablett „BRÖTCHENSCHÜTTE“

tray
bandeja
plateau

	cm	↑ cm	Farbe / Colour	€
85140	41 x 18	3,0		28,00
85141	41 x 18	3,0		28,00



85140

Holzoptik
wood lookGriffbereich mit Aufhängeloch
handle area with hanging hole

85141

Schieferoptik
slate lookPräsentationsmöglichkeit
presentation example



Schale, 2-teilig „FRIDA“

bowl, 2 pcs.
cuenca, set de 2
bol, set de 2



inklusive Abtropfeinsatz
including drip tray
con bandeja recoge gotas
avec égouttoir

	Ø cm	↑ cm	€
85230	25,5	6	27,00
85231	33,0	6	46,00

Buffetständer, mit schwarzer Antirutschbeschichtung, für Schalen Nr. 85230, 85231

buffet stand, with black anti-slide coating, for bowls no. 85230, 85231
soporte para buffet, con revestimiento antideslizante negro, para cuencos 85230, 85231
présentoir buffet, avec revêtement antidérapant noir, pour bols 85230, 85231

	Ø cm	↑ cm	€
33282	23 / 30,5	17	42,00



Präsentationsmöglichkeit
presentation example



Servier- und Tortenplatte „CASUAL“

cake plate
porta pasteles
présentoir à gâteaux



	Ø cm	↑ cm	€
83890	31	8	28,60
83891	31	16	36,00



Servier- und Tortenplatte „CASUAL“

cake plate
porta pasteles
présentoir à gâteaux



	cm	↑ cm	€
83892	31 x 31	8	32,00
83893	31 x 31	16	39,00



Torten- / Konditorplatte

cake stand
soporte para pastel
présentoir à gâteaux



Rand fixiert die Haube, mit Antirutsch-Füßchen
carved edge fixes the cover, with non-slip feet
ranura para fijar bien la campana, con pies antideslizantes
bord rainuré pour maintenir ferme la cloche, avec pieds antidérapants

	Ø cm	↑ cm	Farbe / Colour	€
00468	31,0	3,5	White	18,40
00469	31,0	3,5	Black	18,40



Schale „BALANCE“

bowl
cuenco
bol

	Ø cm	↑ cm	ltr.	Farbe / Colour	€
84040	14,5	9,0	0,4		6,40
84041	21,0	13,0	1,5		14,20
84042	24,5	15,0	2,5		18,40
84043	30,0	19,5	5,0		31,00

	Ø cm	↑ cm	ltr.	Farbe / Colour	€
85040	14,5	9,0	0,4		6,40
85041	21,0	13,0	1,5		14,20
85042	24,5	15,0	2,5		18,40
85043	30,0	19,5	5,0		31,00

Buffetständer „KING“ / buffet stand / soporte para buffet / présentoir buffet

	Ø cm	↑ cm	€
03622	15	14	44,00
03623	15	21	48,00



Tablett / Teller

tray / plate
bandeja / plato
plateau / assiette

	Ø cm	↑ cm	Farbe / Colour	€
83869	38	2,5		24,70

Rolltophaube mit verchromtem Kugelgriff

rolltop cover with chrome plated handle
campana abatible con pomo cromado
cloche basculante avec bouton chromé

	Ø cm	↑ cm	€
18388	38	20	24,00



Frischhalte-Haube

cover
campana
cloche

	Ø cm	↑ cm	€
06510	30	11,5	5,90

mit verchromtem Griff / with chrom plated handle / con botón cromado / avec bouton chromé

	Ø cm	↑ cm	€
06512	30	11,5	8,20

CUTLERY REST



Besteckablage „SMALL WAVE“
cutlery rest
reposa cuchara
pose-cuillère



	cm	↑ cm		€
83897	26 x 13	4,5		10,90



Besteckablage „BOWL“
cutlery rest
reposa cuchara
pose-cuillère



	cm	↑ cm	ltr.	€
83803	22,5 x 11	6	0,5	7,80



Besteckablage „SPOON“
cutlery rest
reposa cuchara
pose-cuillère



	cm	↑ cm		€
83801	26 x 10,5	5		7,40



Servierlöffel „PROFI“
serving spoon
cuchara para servir
cuillère de service



	cm	→ cm	Farbe / Colour	€
84020	7 x 6,5	26,5		5,80
84021	7 x 6,5	26,5		5,80



Salat-Löffel
salad spoon
cuchara para ensalada
cuillère à salade



	cm	→ cm		€
84035	8 x 7	24		2,40



Eierbecher, 4er Set
egg holder, 4 pcs. set
huevera, set de 4
coquetier, set de 4



	Ø cm	↑ cm	pcs.	€
83851	8	3	4	7,80
83848	8,5	2	4	7,40

FINGERFOOD LÖFFEL



Fingerfood Löffel „HALFTONE“

party spoon
cuchara party
cuillère party



	Ø cm	↑ cm	VE / unit	€ / pc.
84158	5,5	7	24	3,70



Fingerfood Löffel „HALFTONE“

party spoon
cuchara party
cuillère party



	cm	↑ cm	VE / unit	€ / pc.
84128	14,5 x 4,5	4,5	12	3,70



Fingerfood-Löffel „LEAF“

party spoon
cuchara party
cuillère party



	cm	↑ cm	Farbe / Colour	VE / unit	€ / pc.
83889	10 x 4,5	1,5		50	2,20
83887	10 x 4,5	1,5		50	2,20
83888	10 x 4,5	1,5		50	2,20



PARTY SPOON



Fingerfood Löffel „HONG KONG“

party spoon
cuchara party
cuillère party



MAX
70°C



	cm	↑ cm	Farbe / Colour	VE / unit	€/ pc.
83486	13 x 4,5	4,5		60	1,50
83487	13 x 4,5	4,5		60	1,50
83424	13 x 4,5	4,5		60	1,50
83426	13 x 4,5	4,5		60	1,50



Fingerfood-Löffel „MING HING“

party spoon
cuchara party
cuillère party



MAX
70°C



	cm	↑ cm	Farbe / Colour	VE / unit	€/ pc.
83842	11 x 4,5	4		60	1,40
83843	11 x 4,5	4		60	1,40



Schale „MINI“

bowl
cuenco
bol



MAX
70°C



	cm	↑ cm	ltr.	VE / unit	€/ pc.
84460	35 x 4,5	3	0,20	10	3,30



Schale, rund „TAO“

bowl, round
cuenco, redondo
bol, rond



MAX
70°C



	cm	↑ cm	ltr.	Farbe / Colour	€
83648	10,5 x 10,0	6,5 / 3,0	0,07		4,20
83649	10,5 x 10,0	6,5 / 3,0	0,07		4,20



Schale „MINI“
bowl
cuenco
bol



	cm	↑ cm	ltr.	Farbe / Colour	VE / unit	€ / pc.
84750	8 x 8	3	0,06		24	3,50



Dipschälchen „APART“
dip bowl
cuenco para dip
ramequin



	Ø cm	↑ cm	ltr.	Farbe / Colour	€
83800	6,5	3,0	0,045		1,70



Dipschälchen „APART“
dip bowl
cuenco para dip
ramequin



	cm	↑ cm	ltr.	Farbe / Colour	€
83808	6,5 x 6,5	3,0	0,05		1,80



Dipschälchen „FLOWER POT“
dip bowl
cuenco para dip
ramequin



	Ø cm	↑ cm	ltr.	Farbe / Colour	€
84470	6	3,5	0,04		1,80
84471	6	3,5	0,04		1,80
84472	6	3,5	0,04		1,80



Dipschälchen, 6er Set
dip bowl, 6 pcs.
cuenco para dip, set de 6
ramequin, set de 6



	Ø cm	↑ cm	ltr.	Farbe / Colour	pcs.	€ / set
85240	6	4	0,04		6	10,00
85241	6	4	0,04		6	10,00
85242	6	4	0,04		6	10,00
85243	6	4	0,04		6	10,00
85244	6	4	0,04		6	10,00



Teller „MINI“

plate
plato
assiette



	cm	↑ cm	ltr.	VE / unit	€/ pc.
84444	10,5 x 8,5	2,0	0,07	20	3,70

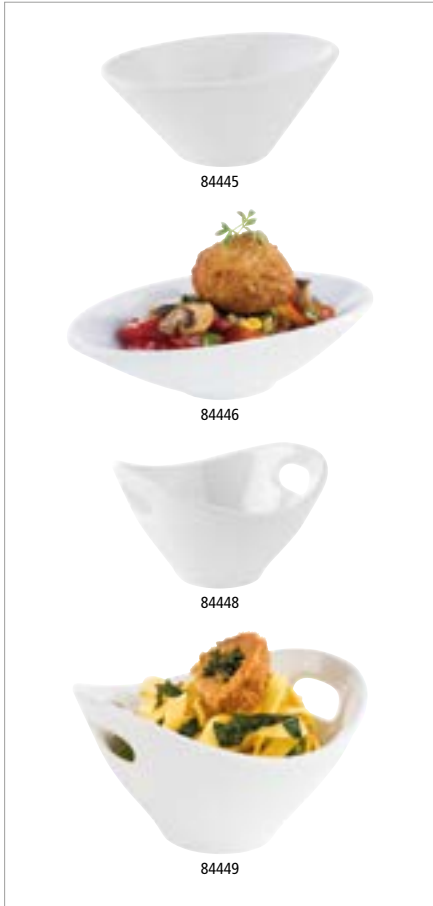

Schale „MINI“

bowl
cuenco
bol



	cm	↑ cm	ltr.	VE / unit	€/ pc.
84445	10,5 x 6,0	4,0	0,07	20	3,70
84446	13,5 x 7,5	3,0	0,07	20	3,70
84448	9,5 x 9,0	5,5	0,09	20	3,70
84449	13,0 x 12,0	7,5	0,18	20	5,00



Schale „MINI“

bowl
cuenco
bol



	cm	↑ cm	ltr.	VE / unit	€/ pc.
84452	11,5 x 7,5	3,0	0,06	24	2,10
84454	11,5 x 6,0	5,5	0,04	24	2,10
84456	8,5 x 7,0	6,0	0,07	24	2,10
84458	8,0 x 8,0	4,0	0,10	24	2,10
84450	7,5 x 7,0	4,5	0,05	24	2,10



Schale „MINI“
bowl
cuenco
bol



	Ø cm	↑ cm	ltr.	Farbe / Colour	€
84775	8,5	2,5	0,07	White	3,20
84778	8,5	2,5	0,07	Black	3,20
84781	8,5	2,5	0,07	Grey	3,20



Schale „MINI“
bowl
cuenco
bol



	Ø cm	↑ cm	ltr.	Farbe / Colour	€
84776	8,5	2,5	0,07	White	3,20
84779	8,5	2,5	0,07	Black	3,20
84782	8,5	2,5	0,07	Grey	3,20



Schale „MINI“
bowl
cuenco
bol



	cm	↑ cm	ltr.	Farbe / Colour	€
84777	9,5 x 5,5	5,5	0,07	White	3,20
84780	9,5 x 5,5	5,5	0,07	Black	3,20
84783	9,5 x 5,5	5,5	0,07	Grey	3,20

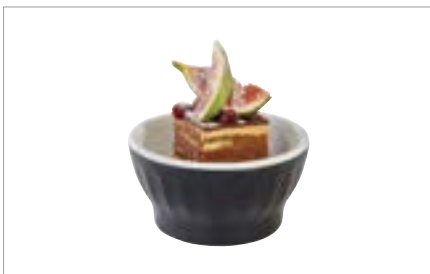

Schale „HALFTONE“
bowl
cuenco
bol



	Ø cm	↑ cm	ltr.	VE / unit	€ / pc.
84217	8,0	4,0	0,1	12	4,00



Dipschälchen „GOURMET“
dip bowl
cuenco para dip
ramequin



	Ø cm	↑ cm	ltr.	€
84018	7	6	0,05	2,60

GN CONTAINERS

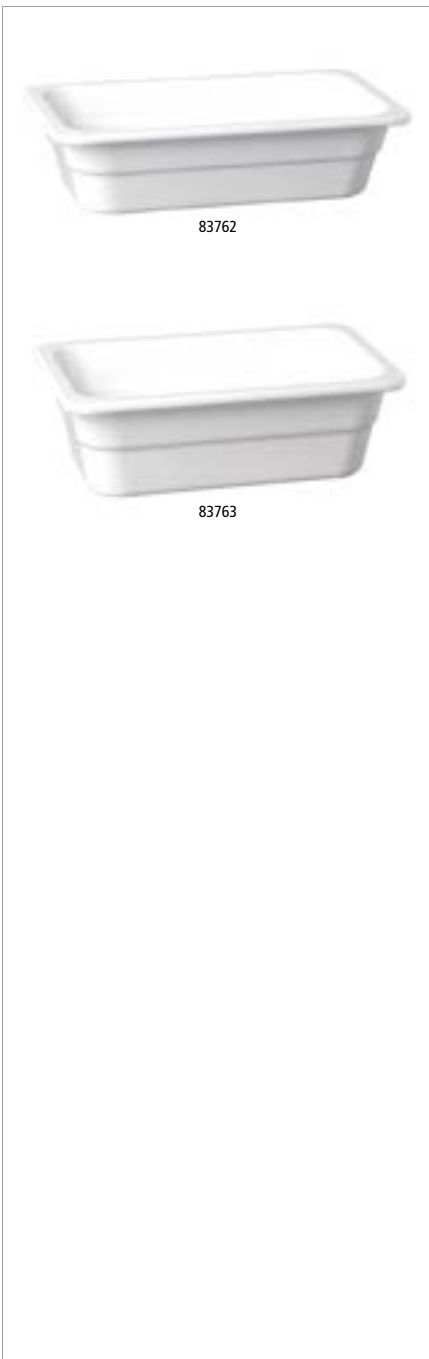

GN-Behälter „HIGHLINE“

GN container
GN cubeta
GN bac



extrem bruchsicher, glänzende und harte Oberfläche, tiefkühlfest, keinen Temperaturschocks unterziehen, nicht auf heißen Flächen liegen lassen, mit Stapelnocke

durable, top quality, hard and glossy surface, avoid thermal shocks, do not leave on hot surfaces, with notching edge

duradera, alta calidad, superficie brillante y resistente, hay que evitar los cambios térmicos bruscos, no apoyar en superficies calientes, con borde para apilamiento

durable, haute qualité, surface brillante et résistante, éviter les chocs thermiques et ne pas poser sur une surface chaude, encoche pour une louche

	GN	↓ mm	ltr.	cm	€
83772	1/1	65	7,10	53,0 x 32,5	41,30
83768	1/2	65	3,40	32,5 x 26,5	22,70
83766	2/4	65	3,00	53,0 x 16,2	26,30
83764	1/3	65	2,00	32,5 x 17,6	17,50
83762	1/4	65	1,35	26,5 x 16,2	16,40
83760	1/6	65	0,80	17,6 x 16,2	12,40

	GN	↓ mm	ltr.	cm	€
83773	1/1	100	11,0	53,0 x 32,5	47,60
83769	1/2	100	5,50	32,5 x 26,5	27,00
83765	1/3	100	3,15	32,5 x 17,6	20,60
83763	1/4	100	2,20	26,5 x 16,2	18,00
83761	1/6	100	1,25	17,6 x 16,2	13,90



83768

stapelbar
stackable



GN-Behälter „ECOLINE“

GN container

GN cubeta

GN bac

mit Stapelnocke

with notching edge

con borde marcado para el apilado

avec rebord pour l'empilage



	GN	↓ mm	litr.	cm	Farbe / Colour	€
83759	1/1	65	7,10	53,0 x 32,5		32,60
83755	2/4	65	3,00	53,0 x 16,2		22,00
83757	1/2	65	3,40	32,5 x 26,5		18,60
83753	1/3	65	2,00	32,5 x 17,6		16,00
83751	1/4	65	1,35	26,5 x 16,2		14,20
83749	1/6	65	0,80	17,6 x 16,2		11,20

	GN	↓ mm	litr.	cm	Farbe / Colour	€
83758	1/1	65	7,10	53,0 x 32,5		32,60
83754	2/4	65	3,00	53,0 x 16,2		22,00
83756	1/2	65	3,40	32,5 x 26,5		18,60
83752	1/3	65	2,00	32,5 x 17,6		16,00
83750	1/4	65	1,35	26,5 x 16,2		14,20
83748	1/6	65	0,80	17,6 x 16,2		11,20

	GN	↓ mm	litr.	cm	Farbe / Colour	€
84300	1/1	100	10,6	53,0 x 32,5		38,00
84302	2/4	100	4,3	53,0 x 16,2		27,40
84301	1/2	100	4,7	32,5 x 26,5		22,60
84303	1/3	100	2,7	32,5 x 17,6		18,40
84304	1/4	100	1,9	26,5 x 16,2		16,00
84305	1/6	100	1,0	17,6 x 16,2		12,20

	GN	↓ mm	litr.	cm	Farbe / Colour	€
84306	1/1	100	10,6	53,0 x 32,5		38,00
84308	2/4	100	4,3	53,0 x 16,2		27,40
84307	1/2	100	4,7	32,5 x 26,5		22,60
84309	1/3	100	2,7	32,5 x 17,6		18,40
84310	1/4	100	1,9	26,5 x 16,2		16,00
84311	1/6	100	1,0	17,6 x 16,2		12,20



GN-Deckel

GN-lid

GN tapa

GN couvercle



	GN	cm	€
82001	1/1	53,0 x 32,5	11,60
82013	1/2	32,5 x 26,5	6,70
82019	1/3	32,5 x 17,6	5,30
82029	1/4	26,5 x 16,2	4,30
82037	1/6	17,6 x 16,2	3,30





Tableware

Table Presentation

LEVANTE	228
SERVING TROWELS.....	230
CAST IRON.....	231
SERVING POTS.....	232
SNACKHOLDERS	234
DIP BOWLS	238
PARTY SPOONS	240
BOWLS WOOD	241
SERVING BOARDS WOOD.....	243
SERVING BOARDS NATURAL SLATE....	249
TRAYS BOARDS.....	251
SALT- / PEPPER MILLS.....	252
MENAGES	259
SUGAR DISPENSERS.....	267
BUTTER DISHES EGG HOLDERS.....	270
FONDUE CAVIAR COOLER SKEWER....	271
TABLE CADDYS	272
CANDLE HOLDERS.....	274
FLOWER VASES.....	275
PLACEMATS.....	276
ENAMELWARE	279
GLASSES.....	281
SEAFOOD.....	287
CAKE STANDS.....	288
SUPER DOME.....	290
GRAVY BOATS.....	291
PLATE TRAYS.....	292
COASTERS.....	293
CUTLERY BINS WASTE BINS.....	294
MENU HOLDERS.....	297
TO GO CUP	305

LEVANTE



Levante Küche passend serviert! Viel Gemüse, wenig Fleisch und eine Vielfalt an Gewürzen charakterisieren die Küche des Nahen Ostens. Der östliche Mittelmeerraum, also Syrien, Libanon, Jordanien, Israel und Palästina wird als Levante bezeichnet. Als Levante-Küche wird die Essenstradition dieser Länder als Food-Trend gefeiert.

Levantine cuisine served appropriately! Lots of vegetables, little meat and a variety of spices characterise the cuisine of the Middle East. The eastern Mediterranean region, i. e. Syria, Lebanon, Jordan, Israel and Palestine is referred to as the Levant. As Levantine cuisine, the food tradition of these countries is celebrated as a food trend.

Cocina levantina servida como es debido. Mucha verdura, poca carne y una gran variedad de especias caracterizan la cocina de Oriente Medio. La región del Mediterráneo oriental, es decir, Siria, Líbano, Jordania, Israel y Palestina, se denomina Levante. La cocina levantina, la tradición alimentaria de estos países, se celebra como una tendencia alimentaria.

Cuisine levantine servie comme il se doit! Beaucoup de légumes, peu de viande et une variété d'épices caractérisent la cuisine du Moyen-Orient. La région de la Méditerranée orientale, c'est-à-dire la Syrie, le Liban, la Jordanie, Israël et la Palestine, est appelée le Levant. La tradition alimentaire de ces pays, la cuisine levantine, est célébrée comme une tendance alimentaire.



Flaschenkühler „LEVANTE“

bottle cooler
enfriador de botella
rafraîchisseur de bouteille



doppelwandig für beste Isolierung, für 0,7 - 1,5 Liter-Flaschen

double wall cooler keeps the temperature for a long time, for 0,7 - 1,5 ltr. bottles

doble pared para mantener el frío largo tiempo, para botellas de 0,7 - 1,5 ltr.

double paroi pour une meilleure conservation de la température, pour bouteilles de 0,7 à 1,5 l.

	cm	↑ cm	Farbe / Colour	€
36125	12 / 10	20		23,00
36127	12 / 10	20		23,00



Tablett „LEVANTE“

tray
bandeja
GN plateau



	cm	↑ cm	ltr.	Farbe / Colour	€
40712	26,5 x 16	3	0,70		16,00
40713	26,5 x 16	3	0,70		16,00



Präsentationsmöglichkeit
presentation example



Schale „LEVANTE“

bowl
cuenco
bol



	Ø cm	↑ cm	ltr.	Farbe / Colour	€
40700	9,5	4,5	0,14		8,00
40701	9,5	4,5	0,14		8,00
40702	12	6,5	0,32		12,40
40703	12	6,5	0,32		12,40
40704	17	8,5	0,90		19,00
40705	17	8,5	0,90		19,00



stapelbar
stackable



Schale „LEVANTE“

bowl
cuenco
bol



	Ø cm	↑ cm	ltr.	Farbe / Colour	€
40706	7,5	2,5	0,05		4,90
40707	7,5	2,5	0,05		4,90
40708	8,5	5,5	0,20		7,40
40709	8,5	5,5	0,20		7,40
40710	8,5	8,5	0,40		8,00
40711	8,5	8,5	0,40		8,00

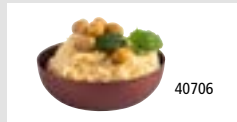

Präsentationsmöglichkeit
presentation example

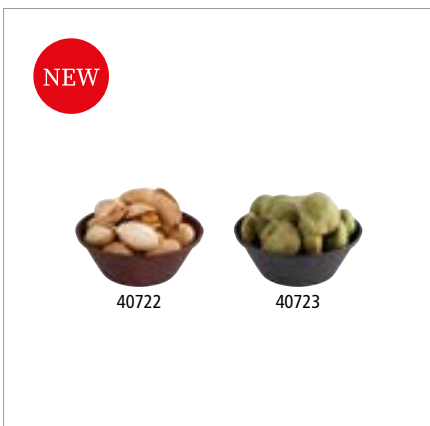

Dipschälchen, 6er Set „LEVANTE“

dip bowl, 6 pcs.
cuenco para dip, set de 6
ramequin, set de 6



	Ø cm	↑ cm	ltr.	Farbe / Colour	pcs.	€ / set
40722	6,0	2,5	0,04		6	15,00
40723	6,0	2,5	0,04		6	15,00



Präsentationsmöglichkeit
presentation example



Dipschälchen, 6er Set „LEVANTE“

dip bowl, 6 pcs.
cuenco para dip, set de 6
ramequin, set de 6



	Ø cm	↑ cm	ltr.	Farbe / Colour	pcs.	€ / set
40726	6,0	4,5	0,06		6	16,00
40727	6,0	4,5	0,06		6	16,00

SERVING TROWEL *super trendy*



40680

40681

Servierkelle „BOB“

serving trowel
paleta para servir
truelle de service



Edelstahl Servierkelle mit schwarzem Holzgriff

stainless steel serving trowel with black wooden handle
paleta para servir de acero inoxidable con mango de madera negra
truelle de service en acier inox avec manche en bois noir

	cm	↑ cm	Griff / handle cm		€
40680	23,5 x 15,5	12,5	13,5	stainless steel	16,90
40681	23,5 x 15,5	12,5	13,5	■	16,90

Snackbox „INDUSTRIAL“

snack box
caja tentempié
casse-croûte



Metall, schwarz

metal, black
metal, negro
métal, noir

	cm	↑ cm	ltr.	€
40676	23,0 x 15,5	13,0	2,4	15,20



stapelbar
stackable

CAST IRON



Die Servierpfännchen aus emailiertem Gusseisen dienen dem portionsweisen Servieren und halten die Speisen warm.

The serving pans made of enameled cast iron are used for serving in portions and for keeping the food warm.

Las fuentes de hierro fundido esmaltado se utilizan para servir en porciones y mantener la comida caliente.

Les plateaux de service en fonte émaillée sont utilisés pour servir en portions et garder les aliments au chaud.



Servierpfännchen „CAST IRON“

serving pan
fuente para servir
plat de service

Gusseisen emailiert
enameled cast iron
hierro fundido esmaltado
fonte émaillée



	Ø cm	↑ cm	Farbe / Colour	€
88220	10	2		14,60
88225	10	2		14,60
88221	13	2		16,40
88226	13	2		16,40



Servierpfännchen „CAST IRON“

serving pan
fuente para servir
plat de service

Gusseisen emailiert
enameled cast iron
hierro fundido esmaltado
fonte émaillée



	cm	↑ cm	Farbe / Colour	€
88222	13 x 13	2		16,40
88227	13 x 13	2		16,40
88223	16 x 13	2		18,60
88228	16 x 13	2		18,60
88224	20 x 13	2		20,60
88229	20 x 13	2		20,60





NEW

MUMBAI

NEW



40730 0,30 ltr.



40731 0,35 ltr.



40732 0,60 ltr.

Serviertöpfchen „MUMBAI“

small serving pot
olla pequeña de servir
marmite petite de servir

Edelstahl, außen: Kupfer-Look, gehämmerte Oberfläche, Griffe vergoldet
stainless steel, outside: copper look, hammered surface, handles gold-plated
acero inoxidable, exterior: look cobre, superficie martillada, asas doradas
acier inox, extérieur: look cuivre, surface martelée, poignées dorées



	Ø cm	↑ cm	ltr.	Griff / handle cm	€
40730	9,0	5,5	0,30	2,25	14,00
40731	11,5	4,5	0,35	2,00	14,00
40732	11,5	7,0	0,60	2,25	16,00
40733	14,0	5,0	0,50	1,75	15,00
40734	16,0	5,0	0,70	1,75	16,00

NEW



40735 0,25 ltr.



40736 0,45 ltr.

Mini-Servierpfanne „MUMBAI“

small serving pan
olla pequeña de servir
marmite petite de servir

Edelstahl, außen: Kupfer-Look, gehämmerte Oberfläche, Griffe vergoldet
stainless steel, outside: copper look, hammered surface, handles gold-plated
acero inoxidable, exterior: look cobre, superficie martillada, asas doradas
acier inox, extérieur: look cuivre, surface martelée, poignées dorées



	cm	↑ cm	ltr.	Griff / handle cm	€
40735	12,5 x 8,5	4,0	0,25	2,0	15,00
40736	14,5 x 9,5	4,5	0,45	2,0	16,00

NEW



40737 0,15 ltr.



40738 0,20 ltr.

Schale „MUMBAI“

bowl
cuenco
bol

Edelstahl, außen: Kupfer-Look, gehämmerte Oberfläche, Griffe vergoldet
stainless steel, outside: copper look, hammered surface, handles gold-plated
acero inoxidable, exterior: look cobre, superficie martillada, asas doradas
acier inox, extérieur: look cuivre, surface martelée, poignées dorées

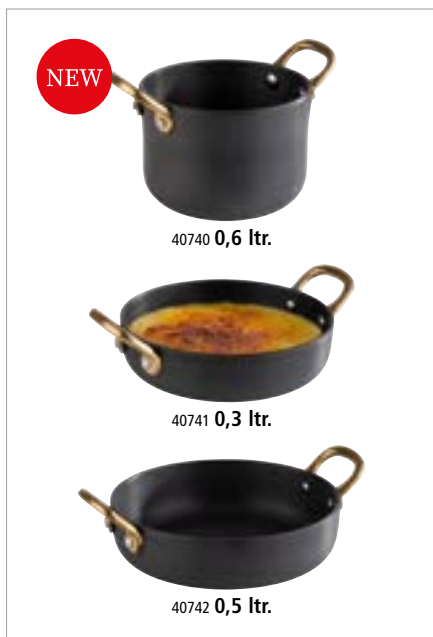

	Ø cm	↑ cm	ltr.	€
40737	8,5	4,5	0,15	6,20
40738	9,0	5,0	0,20	7,50

**Serviertöpfchen**

small serving pot
olla pequeña de servir
marmite petite de servir

Aluminium anthrazit, Griffe aus Messing

aluminium anthracite, brass handles

aluminio antracita, asas de latón

aluminium anthracite, poignées en laiton



	Ø cm	↑ cm	ltr.	Griff / handle cm	€
40740	11,5	9,5	0,6	2,5	25,00
40741	13,5	5,0	0,3	3,5	23,00
40742	15,0	6,0	0,5	2,5	24,00

**Mini-Servierpfanne „SNACKHOLDER“**

mini pan
sartén en formato mini
poêle à frire mini



	cm	↑ cm	ltr.	€
40660	14,5 x 9,5	4,5 / 6,5	0,5	10,00

**Serviertöpfchen „MUMBAI“**

small serving pot
olla pequeña de servir
marmite petite de servir

gehämmerte Oberfläche

hammered surface

superficie martillada

surface martelée



	Ø cm	↑ cm	ltr.	Griff / handle cm	€
40186	9,5	5,5	0,30	2,5	8,60
40187	13,5	5,0	0,55	3,0	9,80
40188	15,5	5,0	0,75	3,0	11,60

**Stielkasserolle / Serviertopf**

sauté pan / mini sauce pan
cazo recto bajo
plat à sauter

hochglanzpoliert

mirror polished

pulido brillante

poli brillant



	Ø cm	↑ cm	ltr.	Griff / handle cm	€
40642	5,5	2,5	0,05	6	4,90
40643	7,0	3,5	0,12	8,5	5,50
40644	9,5	5,5	0,32	8,5	8,70

SNACKHOLDER



Die Mini-Edelstahlkörbchen dienen dem portionsweisen Servieren. Zum originellen Servieren von Beilagen geeignet, aber auch zum Frittieren selbst.

The mini frying baskets are used to present individual portions in an original way, but can still be used to fry.

Las mini cestas para freír se utilizan para presentar las porciones individuales de forma original, pero pueden seguir utilizándose para freír.

Les paniers à friture offrent une présentation originale pour servir apéritifs, snacks, tapas et autres rations individuelles. Également aptes pour frire.



Servier-Frittierkorb „SNACKHOLDER“

stainless steel fry baskets
cestitas inox para el servicio mesa
paniers inox pour le service sur table



	Ø cm	↑ cm	Griff / handle cm	Farbe / Colour		€
40600	8	7,5	9,5		stainless steel	9,20
40602	8	7,5	9,5		gold	11,80
40624 <small>NEW</small>	8	7,5	9,5		black mat	11,80
40601	9	8,5	9,0		stainless steel	11,20
40603	9	8,5	9,0		gold	13,60
40625 <small>NEW</small>	9	8,5	9,0		black mat	13,60



Servier-Frittierkorb „SNACKHOLDER“

stainless steel fry baskets
cestitas inox para el servicio mesa
paniers inox pour le service sur table



	cm	↑ cm	Griff / handle cm	Farbe / Colour		€
40610	21,5 x 10,5	4,5	9,5		stainless steel	15,40
40612	21,5 x 10,5	4,5	9,5		gold	18,20
40628 <small>NEW</small>	21,5 x 10,5	4,5	9,5		black mat	18,20
40611	26,0 x 13,0	5,0	9,0		stainless steel	18,20
40613	26,0 x 13,0	5,0	9,0		gold	21,00
40629 <small>NEW</small>	26,0 x 13,0	5,0	9,0		black mat	21,00



Servier-Frittierkorb „SNACKHOLDER“

stainless steel fry baskets
cestitas inox para el servicio mesa
paniers inox pour le service sur table



	cm	↑ cm	Griff / handle cm	Farbe / Colour		€
40620	10,0 x 8,5	6,5	9,0		stainless steel	12,60
40622	10,0 x 8,5	6,5	9,0		gold	16,40
40626 <small>NEW</small>	10,0 x 8,5	6,5	9,0		black mat	16,40
40621	13,0 x 10,5	9,0	13,5		stainless steel	16,40
40623	13,0 x 10,5	9,0	13,5		gold	20,00
40627 <small>NEW</small>	13,0 x 10,5	9,0	13,5		black mat	20,00



Snackholder
serving cup
vaso para servir
gobelet à apéritif



	Ø cm	↑ cm	ltr.	Farbe / Colour	€
40606	8,5	8,5	0,35	stainless steel	4,20
40617	8,5	8,5	0,35	stainless copper	4,80
40607	8,5	8,5	0,35	hammered surface	4,60
40618	8,5	8,5	0,35	hammered surface	5,40
40605	9,5	8,5 / 11,5	0,45	stainless steel	5,80
40616	9,5	8,5 / 11,5	0,45	stainless copper	6,50

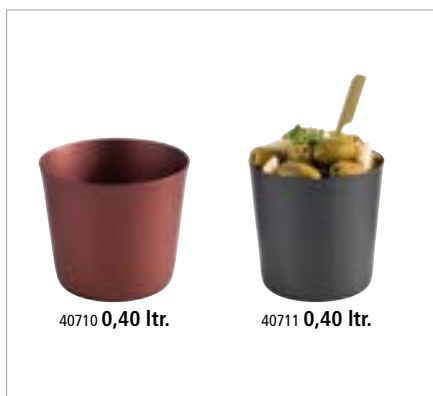

Schale „LEVANTE“
bowl
cuenco
bol



	Ø cm	↑ cm	ltr.	Farbe / Colour	€
40710	8,5	8,5	0,40		8,00
40711	8,5	8,5	0,40		8,00



Servier- / Saucen-Eimer „SNACKHOLDER“

mini stainless steel bucket
cubo inox en formato mini
seau mini inox
hochglanzpoliert
mirror polished
pulido brillante
poli brillant



	Ø cm	↑ cm	ltr.	pcs.	€
40630	7	6,5	0,15	4	13,40
40631	9	8,5	0,33	1	4,80



Mini-Milchkanne „SNACKHOLDER“ 4er Set

mini milk can, 4 pcs.
lechera en formato mini, set de 4
pot à lait mini, set de 4



	Ø cm	↑ cm	ltr.	pcs.	€ / set
40640	4,5	5	0,08	4	16,40

SNACKHOLDERS



Snackcan

serving can
lata para aperitivos
boîte de conserves pour apéritifs

matt poliert
matt polished
pulido mate
poli mat



	Ø cm	↑ cm	ltr.		€
40654	6,5	4,0	0,12	ideale Beilagen Größe	2,70
40655	7,5	5,5	0,17		3,20
40656	7,5	10,0	0,35		4,00
40659	12,0	8,0	0,80		7,40
40658	13,5	14,0	1,80		9,90
40657	13,5	10,5	1,30		9,00

Wachspapier „SNACKHOLDER“ / greaseproof paper squares
papel alimenticio para cucurucho / papier alimentaire pour cornet

	cm	pcs.		€ / set
40670	42 x 25	500	Motiv: Zeitung	59,00



Präsentationsmöglichkeit
presentation example



Schale

bowl
cuenco
bol
hochglanzpoliert
mirror polished
pulido brillante
poli brillant



	Ø cm	↑ cm	ltr.	€
40685	6	3,0	0,05	2,40
40686	8	4,5	0,17	3,60



Schale "MUMBAI"

bowl
cuenco
bol
gehämmerte Oberfläche
hammered surface
superficie martillada
surface martelée



	Ø cm	↑ cm	ltr.	€
40185	9,5	3	0,15	4,00



40690 0,7 ltr.



40691 0,7 ltr.



40692 0,7 ltr.



40693 1,4 ltr.



40694 1,4 ltr.



40695 1,4 ltr.

Schale
bowl
cuenco
bol

gehämmerte Oberfläche
hammered surface
superficie martillada
surface martelée



	Ø cm	↑ cm	ltr.	Farbe / Colour	€
40690	15,5 x 12,0	5,5	0,7	gold look	13,60
40691	15,5 x 12,0	5,5	0,7	copper look	13,60
40692	15,5 x 12,0	5,5	0,7	gunmetal-look	13,60
40693	23,0 x 15,5	6,0	1,4	gold look	20,40
40694	23,0 x 15,5	6,0	1,4	copper look	20,40
40695	23,0 x 15,5	6,0	1,4	gunmetal-look	20,40



Präsentationsmöglichkeit
presentation example



40604

Servierkorb „BURGER & FRIES“

serving basket
cesta para servir
corbeille de service

Servierkorb aus Metall mit 2 Haltern für Dipschälchen

metal serving basket with 2 holders for dip bowls

cesta de metal para servir con 2 soportes para cuencos para dip

corbeille de service en métal avec 2 supports pour ramequins



	cm	↑ cm	€
40604	39,5 x 20	11	10,00

passende Schälchen / suitable bowls / cuencos adecuados / bols
appropriés



	Ø cm	↑ cm	ltr.	VE / unit	€ / pc.
83781	7,5	4	0,07	24	1,50



83781

Servierbeispiel - Lieferung ohne Schälchen
delivery without bowls



Präsentationsmöglichkeit
presentation example

DIP BOWLS



Ob Nachos mit Käsedip, Gemüsesticks mit Joghurtsoße oder eine Käseplatte mit Feigensenf: All diese Köstlichkeiten finden in Dipschalen ihren Platz und regen den Appetit Ihrer Gäste an.

Whether nachos with cheese dip, vegetable sticks with yoghurt sauce or cheese platter with fig mustard: all these delicacies find their place in dip bowls and stimulate the appetite of your guests.

Ya sean nachos con dip de queso, palitos de verdura con salsa de yogur o tabla de quesos con mostaza de higos: todas estas delicias encuentran su lugar en los cuencos para dip y estimulan el apetito de sus invitados.

Qu'il s'agisse de nachos avec trempette au fromage, de bâtonnets de légumes avec sauce au yaourt ou d'un plateau de fromage avec moutarde aux figues : tous ces délices trouvent leur place dans les bols à trempette et stimulent l'appétit de vos invités.

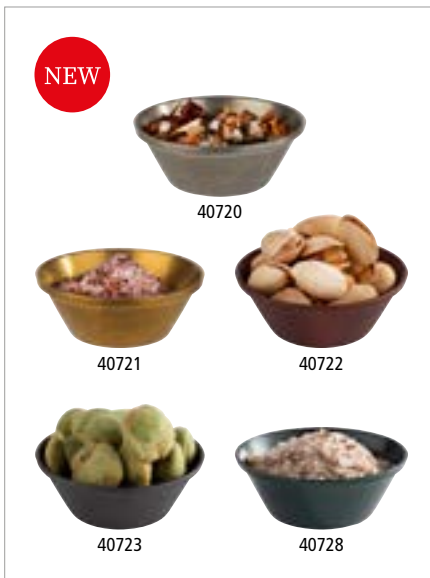

Dipschälchen, 6er Set dip bowl, 6 pcs. cuenco para dip, set de 6 ramequin, set de 6



	Ø cm	↑ cm	ltr.	Farbe / Colour	pcs.	€ / set
40720	6,0	2,5	0,04		6	16,00
40721	6,0	2,5	0,04		6	20,00
40722	6,0	2,5	0,04		6	15,00
40723	6,0	2,5	0,04		6	15,00
40728	6,0	2,5	0,04		6	15,00

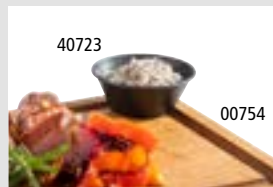

Präsentationsmöglichkeit
presentation example



Dipschälchen, 6er Set dip bowl, 6 pcs. cuenco para dip, set de 6 ramequin, set de 6



	Ø cm	↑ cm	ltr.	Farbe / Colour	pcs.	€ / set
40724	6,0	4,5	0,06		6	17,00
40725	6,0	4,5	0,06		6	21,00
40726	6,0	4,5	0,06		6	16,00
40727	6,0	4,5	0,06		6	16,00
40729	6,0	4,5	0,06		6	16,00



Dipschälchen, 12er Set
dip bowl, 12 pcs.
cuenco para dip, set de 12
ramequin, set de 12



	Ø cm	↑ cm	ltr.	Farbe / Colour	pcs.	€/ set
40760	6,0	3,5	0,04	—	12	13,00
40761	6,0	3,5	0,04	—	12	13,00
40762	6,0	3,5	0,04	—	12	13,00
40763	7,0	3,5	0,07	—	12	15,00
40764	7,0	3,5	0,07	—	12	15,00
40765	7,0	3,5	0,07	—	12	15,00
40766	7,5	4,0	0,09	—	12	17,00
40767	7,5	4,0	0,09	—	12	17,00
40768	7,5	4,0	0,09	—	12	17,00



Dipschälchen, 6er Set
dip bowl, 6 pcs.
cuenco para dip, set de 6
ramequin, set de 6



	Ø cm	↑ cm	ltr.	Farbe / Colour	pcs.	€/ set
85240	6,0	4,0	0,04	—	6	10,00
85241	6,0	4,0	0,04	—	6	10,00
85242	6,0	4,0	0,04	—	6	10,00
85243	6,0	4,0	0,04	—	6	10,00
85244	6,0	4,0	0,04	—	6	10,00



Dipschälchen „FLOWER POT“
dip bowl
cuenco para dip
ramequin



	Ø cm	↑ cm	ltr.	Farbe / Colour	VE / unit	€/ pc.
84470	6,0	3,5	0,04	—	60	1,80
84471	6,0	3,5	0,04	—	60	1,80
84472	6,0	3,5	0,04	—	60	1,80



Dipschälchen „CASUAL“
dip bowl
cuenco para dip
ramequin



	Ø cm	↑ cm	ltr.	Farbe / Colour	VE / unit	€/ pc.
83780	6,0	4,0	0,04	—	24	1,20
83781	7,5	4,0	0,07	—	24	1,50
83782	8,0	4,5	0,08	—	24	1,90
83783	8,5	4,5	0,12	—	24	2,00
83798	6,0	4,0	0,04	—	24	1,40
83777	6,0	3,5	0,03	—	24	1,40



Dipschälchen „GOURMET“
dip bowl
cuenco para dip
ramequin



	Ø cm	↑ cm	ltr.	Farbe / Colour	VE / unit	€/ pc.
84018	7,0	6,0	0,05	—	20	2,60

PARTY SPOONS



Gourmetlöffel/-gabel, 6er Set

tapas spoon / fork, 6 pcs.
cuchara / tenedor de tapas, set de 6
cuillère / fourchette à tapas, set de 6

Verwendung als Löffel oder Gabel möglich

can be used as a spoon or fork

puede utilizarse como cuchara o tenedor

peut être utilisé comme une cuillère ou une fourchette



	→ cm	pcs.	€/ set
00699	10	6	9,00



Gourmet-Löffel „CLASSIC“

party spoon
cuchara gourmet
cuillère gourmet



	→ cm			€
00693	12,0	gunmetal look	PVD coated stainless steel	5,70
00677	13,5	stainless steel look		2,80
00691	12,0	gold look	PVD coated stainless steel	5,70
00692	12,0	copper look	PVD coated stainless steel	5,70

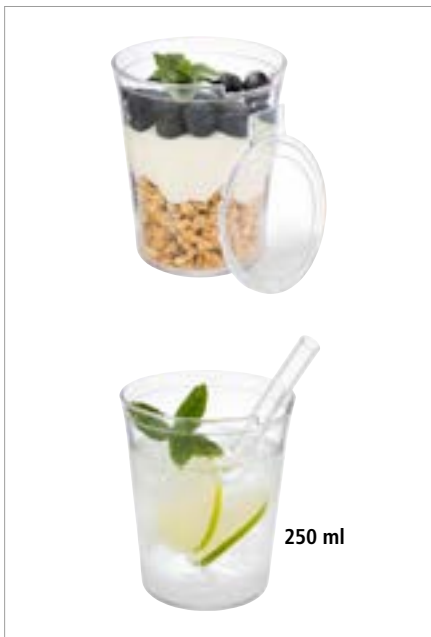

Becher Set „SUPER CUP“, 8er Set

barrel mug set, 8 pcs.

vasos, set de 8

gobelets, set de 8

Set bestehend aus 8 Bechern + 8 Deckeln

set consists of 8 barrel mugs + 8 lids

set compuesto por 8 vasos + 8 tapas

set composé de 8 gobelets + 8 couvercles



**IDEAL
FÜR
„TAKE AWAY“**

	Ø cm	↑ cm	ltr.	pcs.	€/ set
10506	8	10	0,25	8	19,00



mit Stapelnocke
with stacking cam



rutschfester Deckel
non-slip lid



Snackspender

snack dispenser
dispensador de snacks
distributeur de snacks

Behälter aus Glas, Schraubdeckel aus Edelstahl, Öffnung oval 3,5 x 2,5 cm

glass container, stainless steel screw cap, opening oval 3,5 x 2,5 cm

recipiente de cristal, tapón de rosca de acero inoxidable, apertura ovalada 3,5 x 2,5 cm

réipient en verre, couvercle à visser en acier inox, ouverture ovale 3,5 x 2,5 cm



	Ø cm	↑ cm	ltr.	Farbe / Colour	€
40516	8,5	15,5	0,35	Gold	8,00
40517	8,5	15,5	0,35	Schwarz	8,00

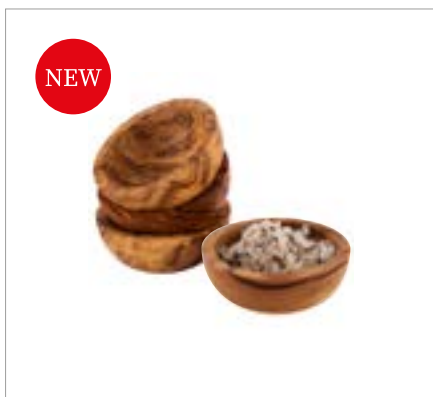

Schale, 4er Set „OLIVE“

bowl, 4 pcs.
cuenco, set de 4
bol, set de 4



aus geöltem Olivenholz, naturbedingte Abweichung in Form, Maserung und Größe
oiled olive wood, natural deviation in shape, grain and size
de madera de olivo aceitada, diferencias naturales posibles en forma, grano y tamaño
en bois d'olivier huilé, éventuelles différences naturelles de forme, de grain et de taille

	Ø cm	↑ cm	ltr.	pcs.	€ / set
01024	6	2	0,03	4	14,00



Schale, 2er Set „OLIVE“

bowl, 2 pcs.
cuenco, set de 4
bol, set de 4



aus geöltem Olivenholz, naturbedingte Abweichung in Form, Maserung und Größe
oiled olive wood, natural deviation in shape, grain and size
de madera de olivo aceitada, diferencias naturales posibles en forma, grano y tamaño
en bois d'olivier huilé, éventuelles différences naturelles de forme, de grain et de taille

	cm	↑ cm	ltr.	pcs.	€ / set
01025	12,5 x 8	2,5	0,05	2	10,00



01010 0,15 ltr.

01011 0,25 ltr.

01012 0,50 ltr.

Schale „OLIVE“

bowl
cuenco
bol



aus geöltem Olivenholz, naturbedingte Abweichung in Form, Maserung und Größe
oiled olive wood, natural deviation in shape, grain and size
de madera de olivo aceitada, diferencias naturales posibles en forma, grano y tamaño
en bois d'olivier huilé, éventuelles différences naturelles de forme, de grain et de taille

	Ø cm	↑ cm	ltr.	€
01010	10,0	4,0	0,15	10,00
01011	12,5	4,5	0,25	13,80
01012	15,0	6,0	0,50	20,00



3 Größen ineinander
3 sizes in each other



00843 0,05 ltr.

00844 0,10 ltr.

Schale „OLIVE“

bowl
cuenco
bol





aus geöltem Olivenholz, naturbedingte Abweichung in Form, Maserung und Größe
oiled olive wood, natural deviation in shape, grain and size
de madera de olivo aceitada, diferencias naturales posibles en forma, grano y tamaño
en bois d'olivier huilé, éventuelles différences naturelles de forme, de grain et de taille

	cm	↑ cm	ltr.	€
00843	12,0 x 7,5	2,5	0,05	7,80
00844	16,5 x 9,5	2,5	0,10	10,00



Schale „OLIVE“
 bowl
 cuenco
 bol

aus geöltem Olivenholz
 oiled olive wood
 de madera de olivo aceitada
 en bois d'olivier huilé



HOLZ WOOD  

	cm	↑ cm	ltr.	€
00907	13 x 8	6,5	0,2	6,60
00908	16 x 9	7,0	0,3	10,00
01023	25 x 8,5	7,5	0,4	18,00



Schale „OLIVE“
 bowl
 cuenco
 bol

aus geöltem Olivenholz, naturbedingte Abweichung in Form, Maserung und Größe
 oiled olive wood, natural deviation in shape, grain and size
 de madera de olivo aceitada, diferencias naturales posibles en forma, grano y tamaño
 en bois d'olivier huilé, éventuelles différences naturelles de forme, de grain et de taille



HOLZ WOOD  

	cm	↑ cm	ltr.	€
01013	7,5 x 7,5	2,5	0,05	5,00
01014	17,5 x 8,5	2,5	0,15	12,40
01015	26,5 x 11,5	5,0	0,60	19,00



Servierbrett „OLIVE“
 serving board
 tabla de servir
 planche de service

aus geöltem Olivenholz, naturbedingte Abweichung in Form, Maserung und Größe
 oiled olive wood, natural deviation in shape, grain and size
 de madera de olivo aceitada, diferencias naturales posibles en forma, grano y tamaño
 en bois d'olivier huilé, éventuelles différences naturelles de forme, de grain et de taille

HOLZ WOOD   



	cm	↑ cm	€
01022	39,5 x 21	2,5	32,00
01021	35,5 x 18,5	2,0	24,00

 mit Safrille
 with juice groove



Servierbrett „OLIVE“
 serving board
 tabla de servir
 planche de service

aus geöltem Olivenholz, naturbedingte Abweichung in Form, Maserung und Größe
 oiled olive wood, natural deviation in shape, grain and size
 de madera de olivo aceitada, diferencias naturales posibles en forma, grano y tamaño
 en bois d'olivier huilé, éventuelles différences naturelles de forme, de grain et de taille

HOLZ WOOD   

	cm	↑ cm	€
00905	25,5 x 16,5	1,5	12,00
00906	35,0 x 20,5	1,5	22,00



Servierbrett „OLIVE“

serving board
tabla de servir
planche de service



aus geöltem Olivenholz, mit 19 mm Aufhäng Bohrung, naturbe-
dingte Abweichung in Form, Maserung und Größe

oiled olive wood, natural deviation in shape, grain and size
de madera de olivo aceitada, diferencias naturales posibles en
forma, grano y tamaño

en bois d'olivier huilé, éventuelles différences naturelles de forme,
de grain et de taille

	cm	↑ cm	Griff / handle cm	€
00870	25,0 x 17,0	1,5	-	32,00
00871	30,0 x 20,5	2,0	-	52,00
00875	19,0 x 12,5	1,5	6	23,00
00876	25,0 x 16,0	1,5	8	35,00
00877	31,0 x 20,0	1,5	9	52,00
00873	40,0 x 15,0	1,5	11	56,00
00874	44,0 x 20,0	2,0	12	72,00



SNACKBOX „OLIVE“

snackbox
caja tentempié
casse-croûte



aus geöltem Olivenholz
oiled olive wood

de madera de olivo aceitada
en bois d'olivier huilé

	cm	↑ cm	€
01016	22 x 15	6	21,00
01017	25 x 18	6	29,00



Tablett

tray
bandeja
plateau



aus Bambus, geeignet zum Servieren und Transportieren

made of bamboo, suitable for serving and transport
de bambú, para servir y transportar
en bambou, pour servir et transporter

	cm	↑ cm	GN	€
00845	32,5 x 26,5	3	1/2	13,00
00846	32,5 x 17,6	3	1/3	9,80



Präsentationsmöglichkeit
presentation example

SERVING BOARDS | WOOD



Servierbrett „SHARING“

servicing board
tabla de servir
planche de service



Servierbrett aus geöltem Akazienholz

servicing board made of oiled acacia wood
tabla de servir de madera de acacia aceitada
planche en bois d'acacia huilé

	cm	↑ cm	Griff / handle cm	€
00887	51,5 x 18	1,5	8,5	33,00



2 tlg.
2 pcs.

mit Absatz Ø 5 cm
with hole Ø 5 cm

Servierbrett

servicing board
tabla de servir
planche de service



2-teilig: 1 Holzbrett aus Akazienholz + 1 Naturschieferplatte

2 pcs.: 1 wood board made of acacia wood + 1 natural slate tray
set de 2: 1 tabla de madera de acacia + 1 bandeja de pizarra natural
set de 2: 1 planche en bois d'acacia + 1 plat ardoise naturelle

	cm	↑ cm	€ / set
00814	28 x 17,5	2	16,00



2 tlg.
2 pcs.

Servierbrett

servicing board
tabla de servir
planche de service



2-teilig: 1 Holzbrett aus Akazienholz + 1 Naturschieferplatte

2 pcs.: 1 wood board made of acacia wood + 1 natural slate tray
set de 2: 1 tabla de madera de acacia + 1 bandeja de pizarra natural
set de 2: 1 planche en bois d'acacia + 1 plat ardoise naturelle

	cm	↑ cm	Griff / handle cm	€ / set
00810	26 x 18	2	8	15,00
00811	33 x 20	2	8	18,40
00812	40 x 15	2	5	23,40
00813	43 x 12	2	12	18,40

Präsentationsmöglichkeit
presentation example



mit Hängeloch Ø 2 cm / with a handle-hole Ø 2 cm



Servierbrett „AKAZIE-SCHIEFER“

servicing board
tabla de servir
planche de service



raffiniertes, rustikales Servierbrett aus Akazienholz,

ausgestattet mit einem Naturschieferstreifen zur Kennzeichnung
wood with slate, markable

madera con pizarra, se puede marcar

bois avec ardoise, on peut mettre une inscription

	cm	↑ cm	Griff / handle cm	€
00867	30,5 x 13	1,5	10	18,00
00868	36,5 x 15	1,5	12	23,00
00869	42,0 x 18	1,5	14	26,00



NEW

Servierbrett

serving board
tabla de servir
planche de service



aus geöltem Akazienholz / made of oiled acacia wood / de madera de acacia aceitada / en bois d'acacia huilé

	cm	↑ cm	€
00793	25 x 17	1,5	12,00



Servierbrett

serving board
tabla de servir
planche de service



aus geöltem Akazienholz / made of oiled acacia wood / de madera de acacia aceitada / en bois d'acacia huilé

	cm	↑ cm	€
00897	30 x 15	2	13,60
00898	30 x 18	2	16,00
00899	35 x 25	2	22,40



NEW

Servierbrett

serving board
tabla de servir
planche de service



aus geöltem Akazienholz / made of oiled acacia wood / de madera de acacia aceitada / en bois d'acacia huilé

	cm	↑ cm	€
00792	37 x 8	2	10,00



NEW

Servierschale

serving bowl
cuenca de servir
bol de service



aus geöltem Akazienholz / made of oiled acacia wood / de madera de acacia aceitada / en bois d'acacia huilé

	cm	↑ cm	€
00790	16,5 x 9	2	10,00
00791	23,5 x 13	2	12,00



Servierbrett „NARROW I“

serving board
tabla de servir
planche de service



Akazienholz, mit 3 Vertiefungen Ø 4 cm

acacia wood, with 3 notches Ø 4 cm
madera de acacia, con 3 ranuras Ø 4 cm
bois d'acacia, avec 3 encoches Ø 4 cm

	cm	↑ cm	€
00864	22 x 8	1,5	9,90

passende Schälchen / suitable bowls / cuencos adecuados / bols appropriés



	Ø cm	↑ cm	ltr.		€
82312	6	5,5	0,08	glass / 12 pcs	27,60
40685	6	3,0	0,05	stainless steel	2,40

Servierbeispiel - Lieferung ohne Gläser
delivery without glasses



Servierbrett „NARROW II“

serving board
tabla de servir
planche de service

Akazienholz, mit 3 Vertiefungen Ø 6 cm
acacia wood, with 3 notches Ø 6 cm
madera de acacia, con 3 ranuras Ø 6 cm
bois d'acacia, avec 3 encoches Ø 6 cm



	cm	↑ cm	€
00878	31 x 11	2	11,20

**passende Schälchen / suitable bowls /
cuencos adecuados / bols appropriés**



	Ø cm	↑ cm	ltr.		€
40686	8	4,5	0,17	stainless steel	3,60
82316	7	8	0,22	glass / 12 pcs.	27,60
85080	8	7,5	0,05	melamine / 3 pcs.	32,90
85081	8	7,5	0,05	melamine / 3 pcs.	32,90



Holzbox „TABLE“

woodbox
caja madera
base bois

Akazienholz, 3 Fächer (6,5 x 6,5 cm)
acacia wood, 3 compartments (6,5 x 6,5 cm)
madera de acacia, 3 compartimentos (6,5 x 6,5 cm)
bois d'acacia, 3 compartiments (6,5 x 6,5 cm)



	cm	↑ cm	inner size cm	€
11727	23,5 x 8,5	4,5	6,5 x 6,5 je Fach / each compartment	12,90



Holzbox „TABLE“

woodbox
caja madera
base bois

Akazienholz, natur
acacia wood, nature
madera de acacia, natural
bois d'acacia, naturel



	cm	↑ cm	inner size cm	€
11726	15 x 9,5	5	12 x 6,5	9,90



Serviertablett

serving tray
bandeja para servir
plateau de service

aus geöltem Eichenholz, mit 2 Griffmulden
made of oiled oak wood, with 2 recessed handles
de madera de roble aceitada, con 2 asas empotradas
en bois de chêne huilé, avec 2 poignées encastrées



	cm	↑ cm	€
00761	45 x 35	6	44,00



Präsentationsmöglichkeit
presentation example

NEW

SIMPLY WOOD

 simply
wood.

Eiche, das widerstandsfähigste europäische Holz, ist seit jeher Ausdruck von Qualität, Kraft und Energie.

Eichen werden uralt und riesengroß, sind unvergleichlich stark und standfest.

Oak, the most resistant European wood, has always been an expression of quality, strength and energy.

Oaks grow to be ancient and huge, are incomparably strong and stable.

El roble, la madera europea más resistente, siempre ha sido una expresión de calidad, fuerza y energía.

Los robles se vuelven antiguos y enormes, son incomparablemente fuertes y estables.

Le chêne, le bois européen le plus résistant, est depuis toujours l'expression de la qualité, de la force et de l'énergie.

Les chênes deviennent très vieux et gigantesques, ils sont incomparablement forts et stables.

NEW



00750



00751



00752

Servierbrett „SIMPLY WOOD“

serving board
tabla de servir
planche de service



Eichenholz geölt, mit Aufhängeloch Ø 1,5 cm, mit Lederband

oak wood oiled, with handle hole Ø 1,5 cm, with leather strap

madera de roble aceitada, con agujero para colgar Ø 1,5 cm, con correa de cuero

bois de chêne huilé, avec trou de suspension Ø 1,5 cm, avec ruban en cuir

	cm	↑ cm	→ Griff / handle	€
00750	20 x 20	2	8	25,00
00751	27 x 17	2	8	29,00
00752	32 x 22	2	8	39,00



mit Lederband
with leather strap

NEW



Tablett / Sushiboard „SIMPLY WOOD“

tray / sushiboard
bandeja para sushi
plateau sushi

aus geöltem Eichenholz

made of oiled oak wood

de madera de roble aceitada

en bois de chêne huilé



	cm	↑ cm	€
00753	35 x 17	2	22,00



GN 1/3 Servierbrett „SIMPLY WOOD“

GN 1/3 serving board
GN 1/3 tabla de servir
GN 1/3 planche de service



Eichenholz geölt, mit Vertiefung Ø 4 cm, mit Safrinne
oak wood oiled, with notch Ø 4 cm, with juice groove
madera de roble aceitada, con ranura Ø 4 cm, con ranura para líquidos
bois de chêne huilé, avec encoche Ø 4 cm, avec rigole

	cm	↑ cm	GN	€
00754	32,5 x 17,6	2	1/3	22,00

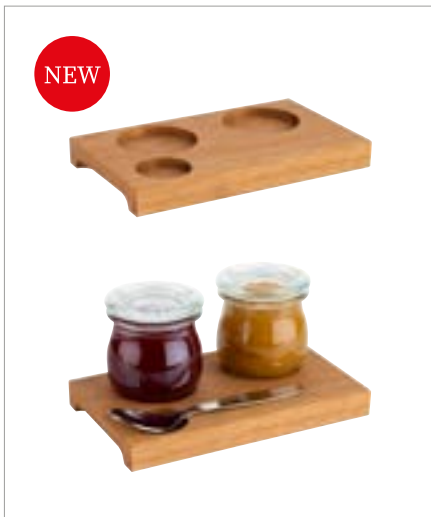

Servierbrett

serving board
tabla de servir
planche de service



Eichenholz, geölt, 2 Vertiefungen Ø 4,5 cm, 1 Vertiefung Ø 3 cm, mit 2 Griffmulden
oak wood oiled, 2 notches Ø 4,5 cm, 1 notch Ø 3 cm, with 2 recessed handles
madera de roble aceitada, 2 ranuras Ø 4,5 cm, 1 ranura Ø 3 cm, con 2 asas empotradas
bois de chêne huilé, 2 encoches Ø 4,5 cm, 1 encoche Ø 3 cm, avec 2 poignées encastées

	cm	↑ cm	€
00835	15 x 9	1,5	10,00

passende Gläser / fitting glasses / tarros de vidrio adecuados / verrines appropriées

	Ø cm	↑ cm	ltr.	pcs	€ / set
82350	5,5	6	0,075	12	22,70
82351	5,5	9	0,145	12	24,80



Servierbrett „PIZZA“

serving board
tabla de servir
planche de service



Eichenholz geölt, mit Safrinne, mit 2 Griffmulden
oak wood oiled, with juice groove, with 2 recessed handles
madera de roble aceitada, con ranura para líquidos, con 2 asas empotradas
bois de chêne huilé, avec rainure à jus, avec 2 poignées encastées

	Ø cm	↑ cm	€
00755	24	2	22,00
00756	29	2	26,00
00757	34	2	30,00



mit 2 Griffmulden an der Unterseite
with 2 recessed handles on the bottom

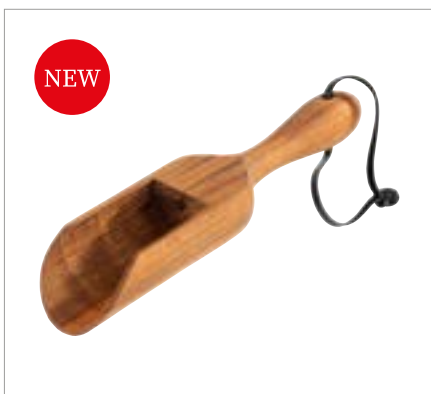

Schaufel

scoop
pala
pelle



aus geöltem Eichenholz, ideal für Gewürze, Körner etc.
made of oiled oak wood, ideal for spices, grains etc.
de madera de roble aceitada, ideal para especias, granos etc.
en bois de chêne huilé, idéal pour les épices, céréales, etc.

	cm	↑ cm	€
01026	25,5 x 6	4,5	14,00

**Servierbrett „OAK“**

serving board
tabla de servir
planche de service

aus geöltem Eichenholz, Safrille, Ø 9,5 cm Aussparung

made of oiled oak, with juice groove, with hole Ø 9.5 cm

de madera de roble aceitada, con ranura para líquidos, con agujero Ø 9,5 cm

en bois chêne huilé, avec rigole, avec trou Ø 9,5 cm



	cm	↑ cm	€
00808	37 x 25	2	29,00



mit Safrille
with juice groove

**Naturschieferplatte**

natural slate tray
bandeja pizarra natural
plat ardoise naturelle

mit Safrille, Ø 9,5 cm Aussparung

with juice groove, with hole Ø 9.5 cm

con ranura para líquidos, con agujero Ø 9,5 cm

avec rigole, avec trou Ø 9,5 cm



	cm	✱ mm	€
00947	33 x 24	6 - 9	11,00

**Naturschieferplatte**

natural slate tray
bandeja pizarra natural
plat ardoise naturelle

mit Absatz Ø 6 cm

with hole Ø 6 cm

con agujero Ø 6 cm

avec trou Ø 6 cm



	cm	✱ mm	€
00986	25 x 12	6 - 9	4,20

**Naturschieferplatte**

natural slate tray
bandeja pizarra natural
plat ardoise naturelle

mit 3 Absätzen, Ø 6 cm

with 3 holes, Ø 6 cm

con 3 agujeros, Ø 6 cm

avec 3 trous, Ø 6 cm



	cm	✱ mm	€
00987	28 x 10	6 - 9	5,80

**Naturschieferplatte „STARTER“**

natural slate tray
bandeja de pizarra natural
plat ardoise naturelle carré



	cm	✱ mm	€
00937	20 x 10	6 - 9	3,10

SERVING BOARDS | NATURAL SLATE



Weck-Glas 82316

Naturschieferplatte / Untersetzer

natural slate tray
bandeja de pizarra natural
plateau ardoise naturelle

mit 2 Absätzen Ø 6 cm / with 2 holes Ø 6 cm / con 2 agujeros Ø 6 cm / avec 2 trous Ø 6 cm



	cm	✱ mm	€
00971	15 x 8	6 - 9	3,40



00941

00942

00945

00988

Naturschieferplatte

natural slate
bandeja de pizarra natural
plateau ardoise naturelle



	cm	✱ mm	€
00941	24,0 x 15,0	6 - 9	4,20
00942	26,5 x 20,5	6 - 9	6,40
00945	47,0 x 10,0	6 - 9	6,40
00988	30,0 x 12,0	6 - 9	4,30

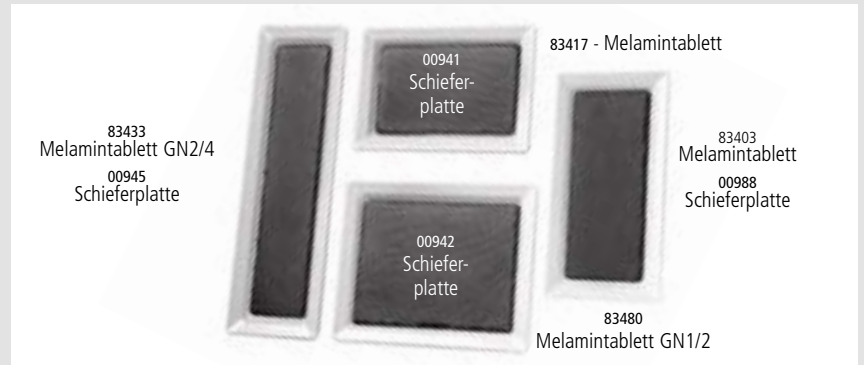

Naturschieferplatte

natural slate tray
bandeja de pizarra natural
plat ardoise naturelle



	cm	✱ mm	€
00996	45 x 30	6 - 9	12,60



00994

Naturschieferplatte

natural slate tray
bandeja de pizarra natural
plat ardoise naturelle



	cm	✱ mm	€
00994	25 x 25	6 - 9	6,40
00995	30 x 30	6 - 9	9,50



Naturschieferplatte, 2-teilig

natural slate tray, 2 pcs. set
bandeja de pizarra natural, set de 2
plateau ardoise naturelle, set de 2

mit Glashaube

with glass cover

con tapa de cristal

avec cloche en verre

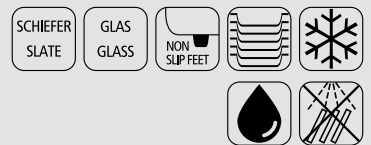

	Ø cm	↑ cm	✱ mm	€
00984	10,5	8	6 - 9	8,50



Tablett „VINTAGE“

tray
bandeja
plateau

Antik-Edelstahl-Look

stainless steel antique look
acero estilo antiguo
acier style antique



	cm	↑ cm		€
30130	26,0 x 13,5	1,5	rectangular	8,00
30131	34,0 x 18,0	1,5	rectangular	13,20
30134	32,0 x 21,5	2,0	rectangular	15,00
30132	38,0 x 26,5	1,5	rectangular	21,00
30133	25,5 x 16,0	3,0	angular	16,00
30140	20 x 14,5	1,0	oval	5,00
30141	26,5 x 19,5	1,0	oval	7,60
30142	29,0 x 22,0	1,0	oval	9,80

passende Schälchen / fitting bowls / cuencos adecuados / bols apropiés



	Ø cm	↑ cm	ltr.	€
40655	7,5	5,5	0,17	3,20
40656	7,5	10	0,35	4,00

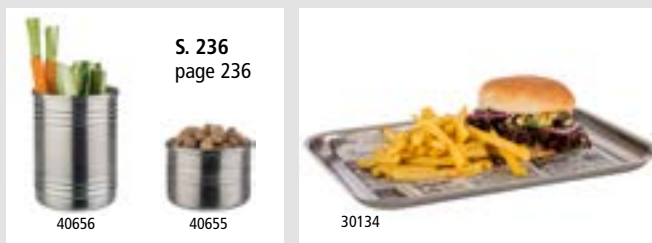

Tablett „TREND“

baking sheet
bandeja
plateau

ein Backblech wird zum Serviertablett

a baking sheet which becomes a serving tray
una bandeja de hornear que se convierte en una bandeja de servir
un moule qui devient un plateau de service



	cm	↑ cm	€
13380	32 x 21,5	2	9,90



Wachspapier „SNACKHOLDER“

greaseproof paper squares
papel alimenticio
papier alimentaire



	cm	pcs.	Motiv:	€
40670	42 x 25	500	Zeitung	59,00

MILLS



Pfeffermühle

pepper mill
molinillo de pimienta
moulin à poivre



aus Buchenholz, **Keramikmahlwerk**, Mahlgrad stufenlos einstellbar

made of beech wood, ceramic grinder, infinitely adjustable grinding degree

madera de haya, molinillo de cerámica, el grado de molino se puede ajustar de modo continuo

bois de hêtre, moulin en céramique, la finesse de mouture se peut réglée de façon continue

	Ø cm	↑ cm	Farbe / Colour	€
40570	5,5	15,5		19,00
40571	5,5	15,5		19,00
40572	6,0	23,0		22,00
40573	6,0	23,0		22,00



Keramikmahlwerk
ceramic grinder

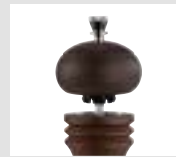

einfach zu Öffnen
easy opening



einfach zu Befüllen
easy to refill



Salzmühle

salt mill
molinillo de sal
moulin à sel



aus Buchenholz, **Keramikmahlwerk**, Mahlgrad stufenlos einstellbar

made of beech wood, ceramic grinder, infinitely adjustable grinding degree

madera de haya, molinillo de cerámica, el grado de molino se puede ajustar de modo continuo

bois de hêtre, moulin en céramique, la finesse de mouture se peut réglée de façon continue

	Ø cm	↑ cm	Farbe / Colour	€
40574	5,5	15,5		19,00
40575	5,5	15,5		19,00
40576	6,0	23,0		22,00
40577	6,0	23,0		22,00



Keramikmahlwerk
ceramic grinder

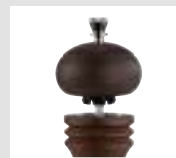

einfach zu Öffnen
easy opening





P



40535

40548

Pfeffermühle „PROFESSIONAL VINTAGE“pepper mill
molinillo de pimienta
moulin à poivre**Deutsches Buchenholz, Mahlwerk aus Carbonstahl, Mahlgrad stufenlos einstellbar**

german beechwood, mill in carbon steel, the grinding degree can be adjusted infinitely

madera de haya alemana, molinillo de acero al carbono, el grado de molino se puede ajustar de modo continuo

bois de hêtre d'Allemagne, moulin en acier de carbone, la finesse de mouture se peut réglée de façon continue

	Ø cm	↑ cm	Farbe / Colour	€
40535	5,5	15		24,70
40537	6,0	23		29,20
40546	5,5	15		24,70
40548	6,0	23		29,20

S



40536

40547

Salzmühle „PROFESSIONAL VINTAGE“salt mill
molinillo de sal
moulin à sel**deutsches Buchenholz, Mahlwerk aus Edelstahl, Mahlgrad stufenlos einstellbar**

german beechwood, mill in stainless steel, the grinding degree can be adjusted infinitely

madera de haya alemana, molinillo de acero inoxidable, el grado de molino se puede ajustar de modo continuo

bois de hêtre d'Allemagne, moulin en acier inox, la finesse de mouture se peut réglée de façon continue

	Ø cm	↑ cm	Farbe / Colour	€
40536	5,5	15		24,70
40547	5,5	15		24,70

P

**Pfeffermühle „GUNMETAL“**pepper mill
molinillo de pimienta
moulin à poivre**Mahlwerk aus Carbonstahl, Mahlgrad stufenlos einstellbar**

mill in carbon steel, the grinding degree can be adjusted infinitely

molinillo de acero al carbono, el grado de molino se puede ajustar de modo continuo

moulin en acier de carbone, la finesse de mouture se peut réglée de façon continue

	Ø cm	↑ cm	€
40555	6	15,5	33,20

S

**Salzmühle „GUNMETAL“**salt mill
molinillo de sal
moulin à sel**Mahlwerk aus Edelstahl, Mahlgrad stufenlos einstellbar**

mill in stainless steel, the grinding degree can be adjusted infinitely

molinillo de acero inoxidable, el grado de molino se puede ajustar de modo continuo

moulin en acier inox, la finesse de mouture se peut réglée de façon continue

	Ø cm	↑ cm	€
40556	6	15,5	33,20

SALT- / PEPPER MILLS



Pfeffermühle „ELEMENT“

pepper mill
molinillo de pimienta
moulin à poivre



Mahlwerk aus Carbonstahl, Mahlgrad stufenlos einstellbar

mill in carbon steel, the grinding degree can be adjusted infinitely
molinillo de acero al carbono, el grado de molino se puede ajustar de modo continuo
moulin en acier de carbone, la finesse de mouture se peut régler de façon continue

	Ø cm	↑ cm	€
40538	6	18	27,00



Salzmühle „ELEMENT“

salt mill
molinillo de sal
moulin à sel



Mahlwerk aus Edelstahl, Mahlgrad stufenlos einstellbar

mill in stainless steel, the grinding degree can be adjusted infinitely
molinillo de acero inoxidable, el grado de molino se puede ajustar de modo continuo
moulin en acier inox, la finesse de mouture se peut régler de façon continue

	Ø cm	↑ cm	€
40539	6	18	27,00



Pfeffermühle „ELEMENT“

pepper mill
molinillo de pimienta
moulin à poivre



Mahlwerk aus Carbonstahl, Mahlgrad stufenlos einstellbar

mill in carbon steel, the grinding degree can be adjusted infinitely
molinillo de acero al carbono, el grado de molino se puede ajustar de modo continuo
moulin en acier de carbone, la finesse de mouture se peut réglée de façon continue

	Ø cm	↑ cm	€
40557	7,5	15,5	23,60



Salzmühle „ELEMENT“

salt mill
molinillo de sal
moulin à sel



Mahlwerk aus Edelstahl, Mahlgrad stufenlos einstellbar

mill in stainless steel, the grinding degree can be adjusted infinitely
molinillo de acero inoxidable, el grado de molino se puede ajustar de modo continuo
moulin en acier inox, la finesse de mouture se peut régler de façon continue

	Ø cm	↑ cm	€
40558	7,5	15,5	23,60



Pfeffermühle „PROFESSIONAL“

pepper mill
molinillo de pimienta
moulin à poivre



Mahlgrad stufenlos einstellbar

the grinding degree can be adjusted infinitely
el grado de molino se puede ajustar de modo continuo
la finesse de mouture se peut réglée de façon continue

	Ø cm	↑ cm	€
40540	5,5	15	20,30



S

Salzmühle „PROFESSIONAL“

salt mill
molinillo de sal
moulin à sel

**Mahlgrad stufenlos einstellbar**

the grinding degree can be adjusted infinitely
el grado de molino se puede ajustar de modo continuo
la finesse de mouture se peut réglée de façon continue

	Ø cm	↑ cm	€
40541	5,5	15	20,30



P

Pfeffermühle „DIAMOND“

pepper mill
molinillo de pimienta
moulin à poivre

**Mahlwerk aus Carbonstahl, Mahlgrad stufenlos einstellbar**

mill in carbon steel, the grinding degree can be adjusted infinitely
molinillo de acero al carbono, el grado de molino se puede ajustar de modo continuo
moulin en acier de carbone, la finesse de mouture se peut réglée de façon continue

	Ø cm	↑ cm	€
40553	6	18	17,80



S

Salzmühle „DIAMOND“

salt mill
molinillo de sal
moulin à sel

**Mahlwerk aus Edelstahl, Mahlgrad stufenlos einstellbar**

mill in stainless steel, the grinding degree can be adjusted infinitely
molinillo de acero inoxidable, el grado de molino se puede ajustar de modo continuo
moulin en acier inox, la finesse de mouture se peut réglée de façon continue

	Ø cm	↑ cm	€
40554	6	18	17,80



P

Pfeffermühle „FRIDA“

pepper mill
molinillo de pimienta
moulin à poivre

**Mahlwerk aus Carbonstahl, Mahlgrad stufenlos einstellbar**

mill in carbon steel, the grinding degree can be adjusted infinitely
molinillo de acero al carbono, el grado de molino se puede ajustar de modo continuo
moulin en acier de carbone, la finesse de mouture se peut réglée de façon continue

	Ø cm	↑ cm	€
40549	6	15,5	17,80



S

Salzmühle „FRIDA“

salt mill
molinillo de sal
moulin à sel

**Mahlwerk aus Edelstahl, Mahlgrad stufenlos einstellbar**

mill in stainless steel, the grinding degree can be adjusted infinitely
molinillo de acero inoxidable, el grado de molino se puede ajustar de modo continuo
moulin en acier inox, la finesse de mouture se peut réglée de façon continue

	Ø cm	↑ cm	€
40550	6	15,5	17,80

SALT- / PEPPER MILLS



P

Pfeffermühle „COPPER“

pepper mill
molinillo de pimienta
moulin à poivre



Mahlwerk aus Carbonstahl, Mahlgrad stufenlos einstellbar

mill in carbon steel, the grinding degree can be adjusted infinitely
molinillo de acero al carbono, el grado de molino se puede ajustar de modo continuo
moulin en acier de carbone, la finesse de mouture se peut réglée de façon continue

	Ø cm	↑ cm	€
40551	6	15	16,50



S

Salzmühle „COPPER“

salt mill
molinillo de sal
moulin à sel



Mahlwerk aus Edelstahl, Mahlgrad stufenlos einstellbar

mill in stainless steel, the grinding degree can be adjusted infinitely
molinillo de acero inoxidable, el grado de molino se puede ajustar de modo continuo
moulin en acier inox, la finesse de mouture se peut réglée de façon continue

	Ø cm	↑ cm	€
40552	6	15	16,50



NEW

3-tlg.
3 pcs.

P

S

40417

40418

Pfeffer- und Salz-Menage „URBAN“

salt- and pepper-menage
salero-pimentero
ménage sel et poivre



3-teiliges Set, bestehend aus:

- Gestell, Metall, schwarz, mit Kartenhalterung
- Pfeffermühle aus Akazienholz mit Mahlwerk aus Carbonstahl
- Salzmühle aus Akazienholz mit Mahlwerk aus Edelstahl

3 pcs., consisting of:

- stand, metal, black, with card holder
- pepper mill made of acacia wood with grinding mechanism made of carbon steel
- salt mill made of acacia wood with grinding mechanism made of stainless steel

set de 3, compuesto por:

- soporte, metal, negro, con porta menu
- molinillo de pimienta de madera de acacia con mecanismo de molienda de acero al carbono
- molinillo de sal de madera de acacia con mecanismo de molienda de acero inoxidable

set de 3, composé de :

- support, métal, noir, avec porte-cartes
- moulin à poivre en bois d'acacia avec broyeur en acier au carbone
- moulin à sel en bois d'acacia avec broyeur en acier inox

	cm	↑ cm	€
40416	12 x 8,5	24	36,00

Pfeffermühle / pepper mill / molinillo de pimienta / moulin à poivre

	Ø cm	↑ cm	€
40417	5	17	16,00

Salzmühle / salt mill / molinillo de sal / moulin à sel

	Ø cm	↑ cm	€
40418	5	17	16,00



Naturschieferplatte / Untersetzer

natural slate tray
bandeja de pizarra natural
plateau ardoise naturelle



mit 2 Absätzen Ø 6 cm / with 2 holes Ø 6 cm / con 2 agujeros Ø 6 cm / avec 2 trous Ø 6 cm

	cm	* mm	€
00971	15 x 8	6 - 9	3,40



2 in 1 Salz- und Pfeffermühle

2 in 1 salt and pepper mill
2 in 1 molinillo de sal y pimienta
2 in 1 moulin à sel et poivre



Keramik Mahlwerk / ceramic mechanism / molinillo de céramica / broyeur en céramique

	Ø cm	↑ cm	€
40545	7,5	18,5	23,00



Mahlgrad einstellbar
grinder setting

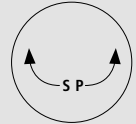

2 in 1 Salz- und Pfeffermühle

2 in 1 salt and pepper mill
2 in 1 molinillo de sal y pimienta
2 in 1 moulin à sel et poivre



Keramik Mahlwerk / ceramic mechanism / molinillo de céramica / broyeur en céramique

	cm	↑ cm	€
40544	6 x 4,5	9,5	21,00



Mahlgrad einstellbar
grinder setting

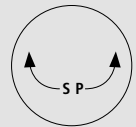

Salz- und Pfefferstreuer, 2er Set

salt - and pepper shaker, 2 pcs.
piezas de sal y pimienta, set de 2
sel et poivre, set de 2



	Ø cm	↑ cm	pcs.	€ / set
40500	5	6,5	2	glatte Ausführung / smooth version versión recta / forme lisse 3,20
40501	5	6,5	2	geriffelte Ausführung / fluted version versión ondulada / forme ondulée 3,20
40507	6	10,0	2	10,40

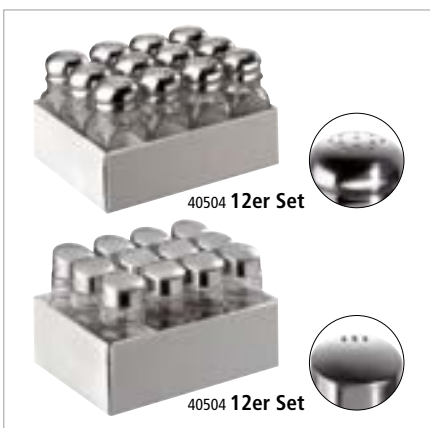

Allzweckstreuer, 12er Set

shaker, 12 pcs.
dosificador, set de 12
salières/poivrières, set de 12



	cm	↑ cm	pcs.	€ / set
40504	4 x 4	10	12	13 Löcher / 13 holes 13 agujeros / 13 trous 23,40
40505	Ø 3	9	12	3 Löcher / 3 holes 3 agujeros / 3 trous 18,60



Ministreuer, 4er Set

mini shaker, 4 pcs.
dosificador mini, set de 4
mini-salières, set de 4



	Ø cm	↑ cm	pcs.	€ / set
40503	3,5	4	4	5,50

SALT- / PEPPER MILLS



Multistreuer

multi-functional shaker
multi dosificador
saupoudreuse



Lochgröße einstellbar / adjustable hole size / tamaño del agujero ajustable / taille du trou réglable

	Ø cm	↑ cm	ltr.	€
00773	6	8	0,05	8,90
00774	7	12	0,20	13,20

	Ø cm	↑ cm	ltr.	€
00781	6,5	12	0,20	12,10
00782	6,5	12	0,20	11,10
00783	6,5	12	0,20	11,10



Netzstreuer

mesh top shaker
polvoreador, tapa con malla fina
pot à épices, couvercle toile fine



	Ø cm	↑ cm	ltr.	€
00776	5,5	7,5	0,15	6,00



Streuer fein

small hole shaker
polvoreador, tapa con agujeros pequeños
pot à épices, couvercle à petits trous



	Ø cm	↑ cm	ltr.	€
00777	5,5	7,5	0,15	5,50



Streuer grob

large hole shaker
polvoreador, tapa con agujeros grandes
pot à épices, couvercle à grands trous



	Ø cm	↑ cm	ltr.	€
00778	5,5	7,5	0,15	5,50



Käse- oder Gewürzstreuer

spice shaker
bote especiero
saupoudreuse à épices



	Ø cm	↑ cm	ltr.	€
00775	5,5	7,5	0,15	6,00



Salzstreuer

salt shaker
salero
salière



Pommes-Frites Streuer mit Schraubkappe / for french fries, cover to screw / para patatas fritas, tapa de rosca / pour les frites, couvercle à visser

	Ø cm	↑ cm		€
00779	8	17	Aluminium / aluminium	9,90
00772	8	17	Edelstahl / stainless steel	14,00

MENAGES



Menage „WOOD“

menage
menage
ménage



matt poliert, Glasbehälter mit Edelstahldeckel und Deckelverschluss

matt polished, glass with stainless steel cover
pulido mate, cristal con tapa de acero inoxidable
verre et inox poli mat, avec couvercle inox

	cm	↑ cm	€
40435	11,5 x 5,5	17	17,70



Menage „WOOD“

menage
menage
ménage



matt poliert, Glasbehälter mit Edelstahldeckel und Deckelverschluss

matt polished, glass with stainless steel cover
pulido mate, cristal con tapa de acero inoxidable
verre et inox poli mat, avec couvercle inox

	cm	↑ cm	€
40436	16 x 7,5	24,5	26,50



Menage „WOOD“

menage
menage
ménage



matt poliert, möbelschonende Unterseite

matt polished, glass with stainless steel cover
pulido mate, con tapa de acero inoxidable
verre et inox poli mat, avec couvercle inox

	cm	↑ cm	€
40437	15,5 x 12	24,5	35,30

Salz- und Pfefferstreuer / salt - and pepper shaker / juego de sal y pimienta / set sel et poivre

	Ø cm	↑ cm	€
40438	4	9	6 Löcher - Ø 1,85 mm 4,20
40439	4	9	18 Löcher - Ø 1,35 mm 4,20

Ersatzglas Essig / Öl / spare glass vinegar / oil / cristal de recambio con tapa „aceite & vinagre“
verre huile ou vinagre

	Ø cm	↑ cm	ltr.	€
40442	6	18,5	0,2	7,00



Menage „ELEMENT“

menage
menage
ménage



Betonständer, Glasbehälter mit Edelstahldeckel, möbelschonende Unterseite

stand made of concrete, glass with stainless steel cover, furniture-friendly underside
soporte de hormigón, recipiente de vidrio con tapa de acero inoxidable, con base anti rayaduras

support en béton, récipient en verre avec couvercle en acier inox, revêtement antirayures

	cm	↑ cm	€
40410	10 x 6	17	17,70



Menage „ELEMENT“

menage
menage
ménage



Betonständer, Glasbehälter mit Edelstahldeckel und tropffreiem Kunststoff-Ausgießer, möbelschonende Unterseite

stand made of concrete, glass with stainless steel cover and non-drip nozzle-spout, furniture-friendly underside

soporte de hormigón, recipiente de vidrio con tapa de acero inoxidable y sistema antigoteo, base anti rayaduras

support en béton, récipient en verre avec couvercle en acier inox et verseur antigoutte, revêtement antirayures

	cm	↑ cm	€
40411	14 x 8	25	26,50



Menage „ELEMENT“

menage
menage
ménage



Betonständer, Glasbehälter mit Edelstahldeckel und Drehverschluss, möbelschonende Unterseite

stand made of concrete, glass with stainless steel cover and screw cap, furniture-friendly underside

soporte de hormigón, recipiente de vidrio con tapa de acero inoxidable y tapón de rosca, base anti rayaduras

support en béton, récipient en verre avec couvercle en acier inox et bouchon à vis, avec revêtement antirayures

	cm	↑ cm	€
40412	12,5 x 12,5	25	37,60



Menage „ELEMENT“

menage
menage
ménage



Betonständer mit Kartenhalterung, Glasbehälter mit Edelstahldeckel und Drehverschluss, möbelschonende Unterseite

stand made of concrete with card holder, glass with stainless steel cover and screw cap, furniture-friendly underside

soporte de hormigón con tarjetero, recipiente de vidrio con tapa de acero inoxidable y tapón de rosca, base anti rayaduras

support en béton avec porte-cartes, récipient en verre avec couvercle en acier inox et bouchon à vis, revêtement antirayures

	cm	↑ cm	€
40413	14 x 13,5	20	37,60



mit Kartenhalterung an der Rückseite
with card holder at the back



Menage „CLASSIC“

menage
menage
ménage



Glasbehälter mit Edelstahldeckel und Drehverschluss

glass with stainless steel cover
vidrio con tapa de acero inoxidable con rosca
en verre avec couvercle inox à visser

	cm	↑ cm	€
40310	10,5 x 6,5	16	18,20



Menage „CLASSIC“

menage
menage
ménage



Glasbehälter mit Edelstahldeckel und Drehverschluss

glass with stainless steel cover
vidrio con tapa de acero inoxidable con rosca
en verre avec couvercle inox à visser

	Ø cm	↑ cm	€
40320	10,5	16	23,00



Menage „CLASSIC“

menage
menage
ménage



Glasbehälter mit Edelstahldeckel und tropffreiem Kunststoff-Ausgießer

with stainless steel cover and non-drip nozzle-spout
vidrio con tapa inox y sistema antigoteo
verre avec couvercle inox et verseur antigoutte

	cm	↑ cm	ltr.	€
40440	14,5 x 8,5	23	0,2	28,40
40450	17,5 x 10,5	23		33,20

Ersatzglas mit Deckel / spare glass with cover / vidrio con tapa / verre + couvercle

	Ø cm	↑ cm	€	
40312	4	9	18 Löcher - Ø 1,35 mm	4,20
40311	4	9	6 Löcher - Ø 1,85 mm	4,20

Ersatzglas mit Deckel „Essig & Öl“ / spare glass with cover „vinegar & oil“ / cristal de recambio con tapa „vinegar & oil“ / verre huile ou vinaige avec couvercle inox et verseur antigoutte

	Ø cm	↑ cm	ltr.	€
40441	6	18,5	0,2	8,00

Ersatzglas mit Deckel „Zahnstocher“ / spare glass with cover „toothpick“ / porta-palillos vidrio con tapa / verre à cure-dents + couvercle

	Ø cm	↑ cm	€
40313	4	9	4,20



Senftöpfchen, 2er Set

mustard glass, 2 pcs. set
piezas vasos mostaza, set de 2
verres à moutarde, set de 2



inklusive Löffel und Edelstahldeckel

including spoons and covers
incluye cucharas y tapas
cuillères et couvercles inclus

	Ø cm	↑ cm	ltr.	pcs.	€
40415	5	6	0,07	2	5,90

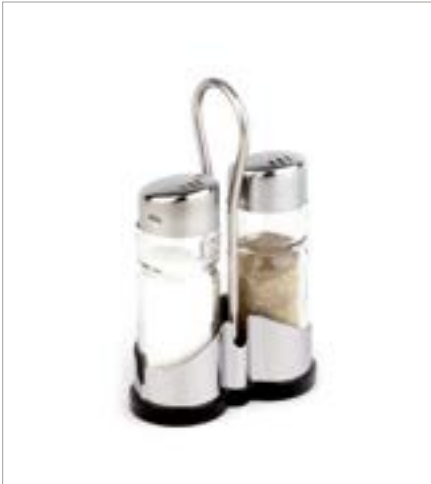

Menage „ECONOMIC“

menage
menage
ménage



Glasbehälter mit Edelstahldeckel und Drehverschluss

glass with stainless steel cover
cristal con tapa inox a rosca
en verre avec couvercle inox à visser

	cm	↑ cm	€
40455	8 x 4	13	4,70



Menage „ECONOMIC“

menage
menage
ménage



Glasbehälter mit Edelstahldeckel und Drehverschluss

glass with stainless steel cover
cristal con tapa inox a rosca
en verre avec couvercle inox à visser

	cm	↑ cm	€
40457	8 x 8	12	7,40

Glas für Senf / glass for mustard / vaso de cristal para mostaza / pot verre seul pour la moutarde

	€
40464	2,00



40458

Menage „ECONOMIC“

menage
menage
ménage



Glasbehälter mit Edelstahldeckel und tropffreiem Kunststoff-Ausgießer

glasses with stainless steel cover and non-drip nozzle-spout
cristales con tapa de acero inoxidable y sistema antigoteo
en verre avec couvercle inox et insert plastique antigoutte

	cm	↑ cm	€
40458	11,5 x 5,5	22	9,60
40460	11,0 x 10,5	22	13,20

Pfeffer- oder Salz-Glasstreuer / pepper- or salt-glass with cover salero o pimentero de cristal con tapa / salière ou poivrière seule en verre avec couvercle inox

	Ø cm	↑ cm	€
40461	3	9	2,20

Essig- oder Öl-Glasbehälter / oil- or vinegar-glass with cover / aceitera-vinagrera con tapa bouteille huile ou vinaigre seule en verre et couv. inox

	Ø cm	↑ cm	€
40462	4,5	16	3,60

Glas für Zahnstocher / glass for tooth picks / vaso de cristal para palillos de dientes porte-cure-dents env erre

	Ø cm	↑ cm	€
40463	3	6	1,50

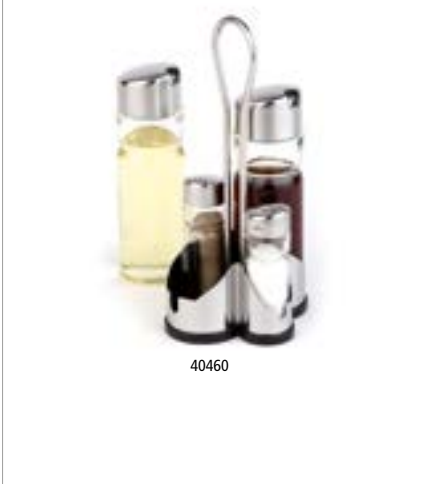

40460



40476



40478



40480

Menage „PRO“

menage
menage
ménage



matt poliert, Glasbehälter mit Edelstahldeckel und tropffreiem Kunststoff-Ausgießer

matt polished, glass with stainless steel cover and non-drip nozzle-spout

pulido mate, vidrio, sistema antigoteo

poli mat et verre, insert plastique antigoutte

	cm	↑ cm	€
40476	12,0 x 8,0	19	11,90
40478	12,5 x 11,0	19	16,70
40480	13,0 x 11,0	19	17,70

Pfeffer- oder Salz-Glasstreuer / pepper- or salt-glass with cover / salero o pimentero de cristal con tapa / salière ou poivrière seule en verre avec couvercle inox

	Ø cm	↑ cm	€
40461	3	9	2,20

Essig- oder Öl-Glasbehälter / oil- or vinegar-glass with cover / aceitera-vinagrera con tapa bouteille huile ou vinaigre seule en verre et couv. inox

	Ø cm	↑ cm	€
40462	4,5	16	3,60



40470



40472



40474

Menage „PRO“

menage
menage
ménage



matt poliert, Glasbehälter mit Edelstahldeckel und Drehverschluss

matt polished, glass with stainless steel cover

pulido mate, vidrio y tapas con rosca

poli mat et verre, couvercle à visser

	cm	↑ cm	€
40470	8,5 x 5,5	11,5	6,10
40472	9,0 x 8,5	11,5	7,70
40474	10,0 x 10,0	11,5	8,70



NEW

Parmesan-Menage „CLASSIC“

cheese dish
quesera parmesano
service à parmesan

schwarz matt, inklusive Löffel
black mat, with spoon
negro, con bol cristal y cuchara
noir, avec bol verre et cuillère



	Ø cm	↑ cm	ltr.	€
40333	11,0	7,0	0,18	22,00

Ersatzbehälter / sparecontainer / bol de recambio / bol de rechange

	Ø cm	↑ cm	ltr.	€
40331	9,0	5,0	0,18	6,40



Parmesan-Menage „CLASSIC“

cheese dish
quesera parmesano
service à parmesan

hochglanzpoliert, inklusive Löffel
mirror polished, with spoon
pulido brillante, con bol cristal y cuchara
poli brillant, avec bol verre et cuillère



	Ø cm	↑ cm	ltr.	€
40330	11,0	7,0	0,18	21,00

Ersatzbehälter / sparecontainer / bol de recambio / bol de rechange

	Ø cm	↑ cm	ltr.	€
40331	9,0	5,0	0,18	6,40



Parmesan-Menage „PROFI“

cheese dish
quesera parmesano
service à parmesan

hochglanzpoliert, inklusive Löffel
mirror polished, with spoon
pulido brillante, con bol cristal y cuchara
brillant, avec bol verre et cuillère



	Ø cm	↑ cm	ltr.	€
40424	9,0	6,5	0,18	16,20

Ersatzbehälter / spare container / bol de recambio / bol de rechange

	Ø cm	↑ cm	ltr.	€
40331	9,0	5,0	0,18	6,40



Parmesan-Menage „PRO“

cheese dish
quesera parmesano
service à parmesan

matt poliert, inklusive Löffel
matt polished, with spoon
pulido mate, con bol cristal y cuchara
poli mat, avec bol verre et cuillère



	Ø cm	↑ cm	ltr.	€
40482	10,5	13,0	0,18	11,00

Ersatzbehälter / sparecontainer / bol de recambio / bol de rechange

	Ø cm	↑ cm	ltr.	€
40331	9,0	5,0	0,18	6,40



Parmesan-Menage „ECONOMIC“

cheese dish
quesera parmesano
service à parmesan
inklusive Kunststofflöffel
with spoon
con cuchara
avec cuillère



	Ø cm	↑ cm	ltr.	€
40453	10,0	7,5	0,23	7,00

Ersatzbehälter / sparecontainer / bol de recambio / bol de rechange

	Ø cm	↑ cm	ltr.	€
40454	9,0	5,5	0,23	2,30



Essig- & Öl-Menage

oil- and vinegar-menage
aceitera-vinagrera
ménage huile et vinaigre



Glasbehälter mit Deckel und tropffreiem PE-Ausgießer

glass with lid and non-drip nozzle-spout
recipiente de cristal con tapa y sistema antigoteo
pot en verre avec couvercle et système plastique antigoutte



	cm	↑ cm	ltr.	€
40445	10,5 x 5,5	24	0,12	10,10
40446	13,0 x 7,0	34	0,50	13,70



tropffreier Ausgießer
non-drip spout



Gewürzständer

condiment stand
soporte salsas y condimentos
porte condiments et sauces



matt poliert
matt polished
pulido mate
poli mat

	Ø cm	↑ cm	€
40300	18	20	20,90



Menage

menage
menage
ménage



drehbares Gestell, Glasbehälter mit Edelstahldeckel und Drehverschluss

rotating stand, glass with stainless steel cover
soporte giratorio con piezas de vidrio y tapas inox
tournant, avec pièces en verre et couvercle inox

	Ø cm	↑ cm	€
40485	16	20	20,40



Ständer „URBAN“

serving stand
soporte 2 botellas
support 2 bouteilles

Metall schwarz, mit Kartenhalterung

metal black, with card holder
metal negro, con tarjetero
métal noir, avec porte-cartes



	cm	↑ cm	€
40414	13 x 8,5	25	7,50

Pfeffermühle / pepper mill / molinillo de pimienta / moulin à poivre

	Ø cm	↑ cm	€
40555	6	15,5	33,20

Salzmühle / salt mill / molinillo de sal / moulin à sel

	Ø cm	↑ cm	€
40556	6	15,5	33,20



mit Kartenhalterung an der Rückseite
with card holder at the back



93308 200 ml

Spritzflasche inklusive Ausgießer

squeeze bottle with nozzle
botella exprimible con dosificador
flacon pulvérisateur avec bec verseur

ideal für Bitter-Liköre, Essig, Öl

perfect for bitter liqueur, vinegar, oil
perfecto para licores amargos, vinagre, aceite
idéal pour liqueur amère, vinaigre, huile



	cm	↑ cm	litr.	€
93308	6 x 5	20	0,2	9,90

Ersatzausgießer passend für Spritzflasche / nozzle suitable for squeeze bottle / dosificador apto para botella exprimible / bec verseur approprié pour flacon pulvérisateur

	Ø cm	↑ cm	€
93309	2,5	5,5	2,80



350 ml

Essig- & Öl-Flasche „OLD FASHIONED“

oil- and vinegar bottle
botella de aceite y vinagre
bouteille d'huile et vinaigre

Glasflasche, Edelstahl - Ausgießer mit Deckel

glass bottle, stainless steel spout with lid
botella de vidrio, pico verteder de acero inoxidable con tapa
bouteille en verre, bec verseur en acier inox avec couvercle



	Ø cm	↑ cm	litr.	€
40511	7	22	0,35	6,40



Zuckerkuigel

sugar pot
azucarero
sucrier

hochglanzpoliert, mit Rolldeckel

mirror polished, rolltop cover
pulido brillante, tapa abatible
poli brillant, couvercle abattant



	Ø cm	↑ cm		€
00033	13,5	15		14,40



Zuckerspender

sugar pourer
dispensador de azúcar
sucrier doseur

matt poliert / matt polished / pulido mate / poli mat



	Ø cm	↑ cm	ltr.	€
10316	5	15	0,17	10,00



Zuckerdosierer

sugar dispenser
azucarero
sucrier

Schraubdeckel aus Edelstahl, mit Dosierrohr

cover stainless steel, with dosing tube
tapa inoxidable y tubo, con tubo dosificador
couvercle inox et tube doseur



	Ø cm	↑ cm	ltr.	€
40509	6	14,5	0,2	12,00



Zuckerdosierer

sugar dispenser
azucarero
sucrier

mit Schraubverschluss, Dosierrohr

cover and dosing tube
con tapa y tubo dosificador
couvercle avec tube doseur



	Ø cm	↑ cm	ltr.	€
40508	6,5	14,5	0,20	11,50



Zuckerdosierer

sugar dispenser
azucarero
sucrier

Schraubdeckel aus Edelstahl / cover stainless steel / tapa inoxidable / couvercle inox



	Ø cm	↑ cm	ltr.	€
00766	8,5	15	0,3	5,50

Ersatzglasbehälter / spare glas-container / contenedor de repuesto / récipient verre de rechange

				€
00768				1,80

SUGAR DISPENSERS



320 ml

Zuckerdosierer

sugar dispenser
azucarero
sucrier



Schraubdeckel aus Edelstahl, mit Dosierrohr

cover stainless steel, with dosing tube
tapa inoxidable y tubo dosificador
couvercle inoxydable et tube doseur

	Ø cm	↑ cm	ltr.	€
40506	7,5	17,0	0,32	5,40



250 ml

Zuckerdosierer

sugar dispenser
azucarero
sucrier



Schraubdeckel aus Edelstahl, mit Dosierrohr

cover stainless steel, with dosing tube
tapa inoxidable y tubo, con tubo dosificador
couvercle inox et tube doseur

	Ø cm	↑ cm	ltr.	€
40486	8	15	0,25	3,90



40490 150 ml

40494 250 ml

Zuckerdosierer

sugar dispenser
azucarero
sucrier



Schraubdeckel aus Edelstahl, mit Dosierrohr

cover stainless steel with dosing tube
tapa inoxidable y tubo dosificador
couvercle inox et tube doseur

	Ø cm	↑ cm	ltr.	€
40490	8,5	12	0,15	3,90
40494	8,0	15	0,25	3,90



320 ml

Zuckerdosierer

sugar dispenser
azucarero
sucrier



Schraubdeckel mit Klappe aus Edelstahl, mit Dosierklappe

cover stainless steel, with dosing flap
tapa acero inoxidable, con tubo dosificador
couvercle inox, avec couvercle doseur

	Ø cm	↑ cm	ltr.	€
40487	7,5	13,5	0,32	4,80



350 ml

Zuckerdosierer „OLD FASHIONED“

sugar dispenser
azucarero
sucrier



Schraubdeckel mit Klappe aus Edelstahl, mit Dosierklappe

cover stainless steel, with dosing flap
tapa acero inoxidable, con tubo dosificador
couvercle inox, avec couvercle doseur

	Ø cm	↑ cm	ltr.	€
40510	7,5	14	0,35	4,10

**Allzweckgießer**

pourer
bote vertedor universal
pot verseur universel

für Honig, Kaffeesahne, etc., Schraubdeckel aus Edelstahl

for honey, cream, etc., cover stainless steel

para miel, crema, etc., tapa inoxidable

pour le miel, le lait, la crème, etc., couvercle inox



	Ø cm	↑ cm	ltr.	€
00765	8,5	13,5	0,3	9,00

Ersatzglasbehälter / spare glas-container / contenedor de repuesto / récipient verre de rechange

	€
00768	1,80

**Allzweckgießer**

pourer
dosificador
doseur

Schraubdeckel aus Edelstahl und Kunststoff, mit Dosierklappe

cover stainless steel and plastic, with dosing flap

acero inoxidable y tapa plástico, con tubo dosificador

couvercle en inox et plastique, avec couvercle doseure



	Ø cm	↑ cm	ltr.	€
40488	8	12,5	0,25	6,80

**Milchkännchen, 4er Set**

milk/cream jugs, 4 pcs.
pack de 4 jarritas para leche o crema
pack de 4 crémiers

hochglanzpoliert, für Kaffeesahne, mit Griff, Inhalt à 25 ml

mirror polished, for coffee-cream, with handle, capacity à 25 ml

pulido brillante, para crema de café, con asa, capacidad 25 ml

poli brillant, avec anse, 25 ml



	Ø cm	↑ cm	pcs.	ltr.	€ / set
10321	3,5	3,5	4	0,025	15,0

**Mini-Milchkanne „SNACKHOLDER“ 4er Set**

mini milk can, 4 pcs.
lechera en formato mini, set de 4
pot à lait mini, set de 4



	Ø cm	↑ cm	ltr.	pcs.	€ / set
40640	4,5	5	0,08	4	16,40

**Milch- und Zucker-Set**

bowl
cuenco
bol

5-teilig: Tablett, Milchkanne, Zuckerdose mit Deckel, Löffel, Akazienholz, Edelstahl PTFE beschichtet, schwarz

5 pcs.: tray, milk jug, sugar bowl with lid, spoon, acacia wood, stainless inox PTFE coated, black

set de 5: bandeja, jarra de leche, azucarero con tapa, cuchara, madera de acacia,

acero inoxidable revestimiento PTFE, negro

set de 5: plateau, pichet à lait, sucrier avec couvercle, cuillère, bois d'acacia, acier inox

revêtement PTFE, noir



	cm	↑ cm	€ / set
00634	19 x 10	10,5	24,00



Butterservierer
butter dish
mantequillera
beurrer



	cm	↑ cm	ltr.	€
15925	Ø 9	9	0,07	8,40
15926	9 x 9	9	0,075	8,40



Butterservierer
butter dish
mantequillera
beurrer



hochglanzpoliert
mirror polished
acabado brillante
poli brillant

	Ø cm	↑ cm	ltr.	€
15921	9	7	0,06	16,00



Schale „ENAMELWARE“
bowl
cuenco
bol



	cm	↑ cm	ltr.	€
40667	16 x 12,0	3,5	0,20	7,90
40668	18 x 13,5	4,0	0,35	8,60



Kühlschrank-Butterdose
refrigerator butter dish
mantequillera para nevera
boîte à beurre pour le frigo



	cm	↑ cm	€
00063	16 x 9,5	5,5	3,90



Eierbecher
egg holder
huevera
coquetier



	Ø cm	↑ cm	€
00032	8,5	2	1,80



Fondue und Feuerzangenbowle-Set „TWO IN ONE“

fondue and fire punch bowl set
set para fondue o ponche caliente
service à fondue et à punch



13-teiliges Set aus Edelstahl bestehend aus:

1 Topf, 1 Rechaud, 1 Spritzschutz, 1 Untersetzer, 1 Schöpfkelle, 1 Feuerzange,
1 Pastenbrenner, 6 Fonduegabeln

13-piece stainless steel set consisting of:

1 pot, 1 rechaud, 1 splash guard, 1 coaster, 1 ladle, 1 fire tongs,
1 paste burner, 6 fondue forks

set de 13 piezas de acero inoxidable compuesto por:

1 olla, 1 rechaud, 1 protector contra salpicaduras, 1 trébede, 1 cazo,
1 pinza para el fuego, 1 quemador de pasta, 6 tenedores de fondue

set de 13 pièces en acier inox comprenant:

1 marmite, 1 rechaud, 1 pare-éclaboussures, 1 dessous de plat, 1 louche, 1 pince à feu,
1 brûleur à pâte, 6 fourchettes à fondue

	Ø cm	↑ cm	ltr.	€ / set
65060	22	23	2,2	54,00



Kaviarkühler

caviar cooler
enfriador de caviar
rafraîchisseur de caviar



4-teilig: Glasschale Ø 10 cm / 4 pcs.: glass bowl Ø 10 cm / set de 4: bol Ø 10 cm
set de 4: bol Ø 10 cm

	Ø cm	↑ cm	€
01699	18	12	56,00

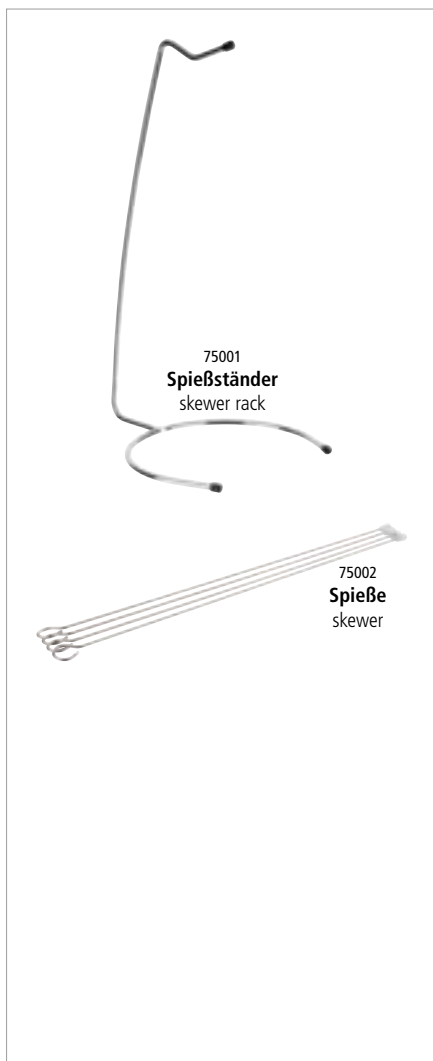

Spießständer

espetada and kebab skewer rack
soporte para brochetas
support pour brochettes



zum Servieren von Fleischspießen bis 40 cm, Gestell aus 8 mm Edelstahl, ohne Spieße

to serve skewers up to 40 cm, wire stainless steel 8 mm, without skewer
para servir brochetas de carne hasta 40 cm, grosor del alambre 8 mm, sin brochetas
pour présenter les brochettes long. maxi 40 cm, fil 8 mm, sans brochettes

	Ø cm	↑ cm	€
75001	22,0	46	36,80

Spieße, 4er Set

skewer, 4 pcs.
brochetas, set de 4
brochettes, set de 4



4er Set, offener Haken, Ende spitz, passend zu 75001

4 pcs., open hook, pointed end, suitable for 75001
set de 4, gancho abierto, extremo puntiagudo, apto para 75001
set de 4, crochet ouvert, extrémité pointue, convient pour 75001

	Ø cm	↑ cm	pcs.	€ / set
75002	0,3	40	4	8,90



Präsentationsmöglichkeit
presentation example

TABLE CADDYS



Table Caddy „ELEMENT“

table caddy
caddy de mesa
caddy de table



Beton, möbelschonende Unterseite, 1 Fach: 14,5 x 14 cm

concrete, furniture-friendly underside, 1 compartment: 14,5 x 14 cm

hormigón, base anti rayaduras, 1 compartimento: 14,5 x 14 cm

béton, revêtement antirayures, 1 compartiment: 14,5 x 14 cm

	cm	↑ cm		€
11647	16,5 x 16	6,5		11,10



Table Caddy „ELEMENT“

table caddy
caddy de mesa
caddy de table



Beton, möbelschonende Unterseite, 1 Fach: 14,5 x 14 cm, 2 Löcher je 6,5 cm

concrete, furniture-friendly underside, 1 compartment: 14,5 x 14 cm, 2 holes each 6.5 cm

hormigón, base anti rayaduras, 1 compartimento: 14,5 x 14 cm, 2 agujeros cada uno 6,5 cm

béton, revêtement antirayures, 1 compartiment: 14,5 x 14 cm, 2 trous de 6,5 cm chacun

	cm	↑ cm	inner size cm	€
11648	23,5 x 16	6,5	14,5 x 14	17,60



Table Caddy

table caddy
caddy de mesa
caddy de table



Akazienholz, 2-Fächer: 21,5 x 8 cm

acacia wood, 2 compartements: 21,5 x 8 cm

madera de acacia, 2 compartimentos: 21,5 x 8 cm

bois d'acacia, 2 compartiments : 21,5 x 8 cm

	cm	↑ cm		€
40405	25 x 15	18		34,80



Table Caddy „VINTAGE“

table caddy
caddy de mesa
caddy de table



Tannenzholz, 2 Fächer: 13,5 x 6 cm

fir wood, 2 compartments: 13,5 x 6 cm

madera de abeto, 2 compartimentos: 13,5 x 6 cm

bois de sapin, 2 compartiments : 13,5 x 6 cm

	cm	↑ cm		€
40404	15,5 x 15,5	15		17,80



Holzbox „WOODY“

woodbox
caja madera
base bois



Akazienholz, 4-Fächer: 12,5 x 8 cm

acacia wood, 4 compartements: 12,5 x 8 cm

madera de acacia, 4 compartimentos: 12,5 x 8 cm

bois d'acacia, 4 compartiments : 12,5 x 8 cm

	cm	↑ cm		€
11649	36 x 14	12,5		16,80



Servierbeispiel - Lieferung ohne Gläser
delivery without glasses

Holzbox „TABLE“

woodbox
caja madera
base bois



Akazienholz, 3 Fächer: 6,5 x 6,5 cm

acacia wood, 3 compartments: 6,5 x 6,5 cm
madera de acacia, 3 compartimentos: 6,5 x 6,5 cm
bois d'acacia, 3 compartiments : 6,5 x 6,5 cm

	cm	↑ cm	€
11727	23,5 x 8,5	4,5	12,90



Holzbox „TABLE“

woodbox
caja madera
base bois



Akazienholz, 1 Fach: 12 x 6,5 cm

acacia wood, 1 compartment: 12 x 6,5 cm
madera de acacia, 1 compartimento: 12 x 6,5 cm
bois d'acacia, 1 compartiment: 12 x 6,5 cm

	cm	↑ cm	€
11726	15,0 x 9,5	5	9,90



Table Caddy

table caddy
caddy de mesa
caddy de table



Akazienholz, 1 Fach: 21,5 x 8 cm

acacia wood, 1 compartment: 21,5 x 8 cm
madera de acacia, 1 compartimento: 21,5 x 8 cm
bois d'acacia, 1 compartiment: 21,5 x 8 cm

	cm	↑ cm	€
11625	23 x 10	10	11,20



Holzbox „WOODY“

woodbox
caja madera
base bois



Akazienholz, 1 Fach: 13 x 13 cm

acacia wood, 1 compartment: 13 x 13 cm
madera de acacia, 1 compartimento: 13 x 13 cm
bois d'acacia, 1 compartiment : 13 x 13 cm

	cm	↑ cm	€
11650	15,0 x 15	5,5	12,50

Akazienholz, 2 Fächer: 13,5 x 13 cm / 6,5 x 13 cm

acacia wood, 2 compartments: 13,5 x 13 cm / 6,5 x 13 cm
madera de acacia, 2 compartimentos: 13,5 x 13 cm / 6,5 x 13 cm
bois d'acacia, 2 compartiments : 13,5 x 13 cm / 6,5 x 13 cm

	cm	↑ cm	€
11651	22,5 x 15	5,5	15,70

CANDLE HOLDERS



Kerzenleuchter

candle holder
candelabro
chandelier



extra schwerer Fuß, verchromt, möbelschonende Unterseite

heavy foot, chrome plated, furniture-friendly underside

pie pesado, asa cromado, base anti rayaduras

piéd lourd, chromé, revêtement antirayures

	Ø cm	↑ cm	Farbe / Colour	€
04020	10	11		14,20
04021	10	16		16,20



Windlichter „ELEMENT“, 2er Set

wind lights, 2 pcs.

portavelas antiviento, set de 2

porte-bougies anti-vent, set de 2

Beton, Gläser klar, möbelschonende Unterseite

concrete, glass clear, furniture-friendly underside

hormigón, vidrio transparente, base anti rayaduras

béton, verre transparente, revêtement antirayures



	Ø cm	↑ cm	pcs.	€ / set
03038	6	8	2	13,00

Ersatzglas / spare glass / vidrio de recambio solo / verre de rechange transparent, seul

	Ø cm	↑ cm	€
03098	6	5	2,90



Windlicht „ELEMENT“

wind light

porta vela

porte-bougie

Beton, Glas klar, möbelschonende Unterseite

concrete, glass clear, furniture-friendly underside

hormigón, vidrio transparente, base anti rayaduras

béton, verre transparente, revêtement antirayures



	Ø cm	↑ cm	€
03039	7,5	13	9,80

Ersatzglas / spare glass / vidrio de recambio solo / verre de rechange transparent, seul

	Ø cm	↑ cm	€
03099	7,5	9	3,60



Vase mit Glaseinsatz „ELEMENT“

flower vase with glass insert
florero con tubo de cristal
vase soliflor avec verre



Beton, Glas klar, möbelschonende Unterseite, inkl. 2 Ersatzgläsern

concrete, clear glass, furniture-friendly underside, incl. 2 spare glasses
hormigón, cristal incoloro, base anti rayaduras, incl. 2 tubos de repuesto
béton, verre transparente revêtement antirayures y compris 2 verres de rechange

	cm	↑ cm	ml	€
04010	10 x 4,5	12,5	25	7,30



Ersatzglas / spare glass / tubo de recambio / verre de rechange

	Ø cm	↑ cm	ml	€
04011	2,5	11	25	1,40



Vase

flower vase
florero
vase soliflor



Edelstahl-Look, Zinkdruckguss, vernickelt, lackiert, anlaufgeschützt, schwere Ausführung
stainless steel look, heavy zink alloy, nickel plated, laquered
aspecto acero, acabado satinado, alta calidad
aspect inox, fini poli mat, bonne qualité

	Ø cm	↑ cm	kg	€
04015	4,0	16,5	0,17	15,00



Vase

flower vase
florero
vase soliflor



Edelstahl-Look, Zinkdruckguss, vernickelt, lackiert, anlaufgeschützt, schwere Ausführung
stainless steel look, heavy zink alloy, nickel plated, laquered
aspecto acero, acabado satinado, alta calidad
aspect inox, fini poli mat, bonne qualité

	Ø cm	↑ cm	kg	€
04017	6,5	18	0,36	17,30



Die umgelegten und angenähten Kanten machen diese Tischsets besonders robust. Geliefert in einer 6er Einheit.

The folded and sewn edges make these table sets particularly robust. Delivered in a packing unit of 6 pieces.

Los bordes doblados y cosidos des los mantelitos los hacen especialmente resistentes. Se entregan en una unidad de embalaje de 6 piezas.

Les bords repliés et cousus rendent ces sets de table en particulierement robustes. Livré dans un emballage de 6 pièces.



Warenträger - Tischsets

display for placemats
expositor para mantelinas de mesa
présentoir pour sets de table

12 Einschubfächer, komplett auf Rollen, 2 Feststellrollen, Lieferung demontiert

12 shelves, on rolls, 2 rolls to fix, delivery unassembled

12 niveles, 4 ruedas, desmontado (montaje fácil)

12 niveaux, 4 roues, livré démonté

	cm	↑ cm
00401	39,5 x 45	165

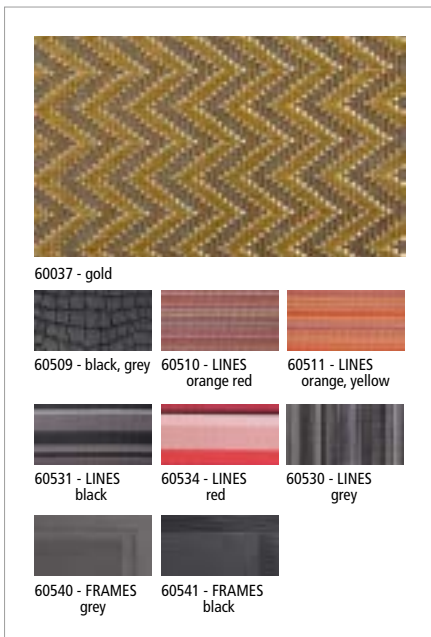

Tischset Feinband

placemat fine band
mantelín cinta fina
set de table, tressage fin



	cm		VE / unit	€ / pc.
60037	45 x 33	gold / gold	6	3,30
60509	45 x 33	Mosaik schwarz, grau / black, grey	6	3,30
60510	45 x 33	LINES orange, rot / LINES orange red	6	3,30
60511	45 x 33	LINES orange, gelb / LINES orange yellow	6	3,30
60531	45 x 33	LINES schwarz / LINES black	6	3,30
60534	45 x 33	LINES rot / LINES red	6	3,30
60530	45 x 33	STRIPES grau / STRIPES grey	6	3,30
60540	45 x 33	FRAMES grau / FRAMES grey	6	3,30
60541	45 x 33	FRAMES schwarz / FRAMES black	6	3,30

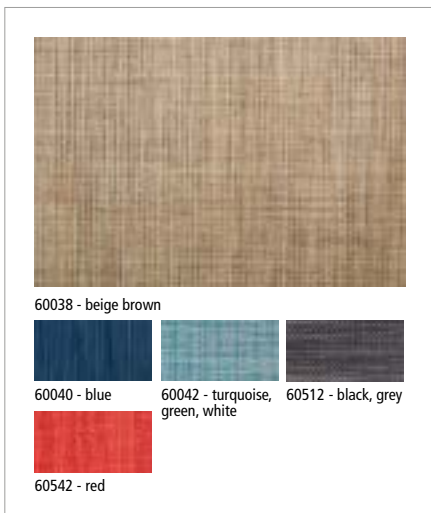

Tischset Feinband

placemat fine band
mantelín cinta fina
set de table, tressage fin



	cm		VE / unit	€ / pc.
60038	45 x 33	beige braun / beige brown	6	3,30
60040	45 x 33	blau / blue	6	3,30
60042	45 x 33	türkis, grün, weiß / turquoise, green, white	6	3,30
60512	45 x 33	schwarz, grau / black, grey	6	3,30
60542	45 x 33	rot / red	6	3,30



60502 - grey, beige



60503 - beige 60505 - brown 60508 - blue

Tischset „TAO“
 placemat fine band
 mantelín cinta fina
 set de table, tressage fin



	cm		VE / unit	€ / pc.
60502	45 x 33	grau, beige / grey, beige	6	4,20
60503	45 x 33	beige / beige	6	4,20
60505	45 x 33	braun / brown	6	4,20
60508	45 x 33	hellblau, dunkelblau / light blue, dark blue	6	4,70



60002 - light blue



60018 - candyred 60012 - black 60014 - beige
 60015 - silvergrey 60016 - green 60019 - beige brown
 60522 - light orange 60520 - black/white 60521 - apple green
 60523 - purple 60524 - platinum 60041 - light blue, white
 60525 - white 60526 - gold 60527 - silver
 60528 - green

Tischset Schmalband
 placemat smallband
 mantelín cinta estrecha
 set de table tressage étroit



	cm		VE / unit	€ / pc.
60002	45 x 33	hellblau / light blue	6	3,30
60018	45 x 33	candyrot / candyred	6	3,30
60012	45 x 33	schwarz / black	6	3,30
60014	45 x 33	beige / beige	6	3,30
60015	45 x 33	silbergrau / silvergrey	6	3,30
60016	45 x 33	grün / green	6	3,30
60019	45 x 33	beige braun / beige brown	6	3,30
60522	45 x 33	hellorange / light orange	6	3,30
60520	45 x 33	schwarz weiß / black white	6	3,30
60521	45 x 33	apfelgrün / apple green	6	3,30
60523	45 x 33	violett / purple	6	3,30
60524	45 x 33	platin / platinum	6	3,30
60041	45 x 33	hellblau, weiß / light blue, white	6	3,30
60525	45 x 33	weiß / white	6	3,30
60526	45 x 33	gold / gold	6	3,30
60527	45 x 33	silber / silver	6	3,30
60528	45 x 33	grün / green	6	3,30



60551



60551 - silbergrau / silvergrey 60552 - beige / braun 60554 - platin

Servietten- und Bestecktaschen, 6er Set
 cutlery bag, 6 pcs. set
 bolsa cubiertos, set de 6
 pochette couverts, set de 6



	cm		pcs.	€ / set
60551	24 x 9	silbergrau / silvergrey	6	4,20
60552	24 x 9	beige braun / beige brown	6	4,20
60554	24 x 9	platin / platinum	6	4,20

PLACEMATS



Tischset placemat mantelín set de table



Kunstleder, mit Naht rundherum

imitation leather, with seam all around
imitación de cuero, con costura alrededor
similicuir, avec couture tout autour

	cm		VE / unit	€ / pc.
60044	45 x 32,5	grau / grey	6	10,80
60045	45 x 32,5	braun / brown	6	10,80
60046	45 x 32,5	schwarz / black	6	10,80



Tischset placemat mantelín set de table



rutschhemmende Unterseite

slip resistant underside
antideslizante por debajo
dessous antiglisse

	cm		VE / unit	€ / pc.
60543	45 x 30	silber / silver	6	5,70



Tischset „PURE“ placemat mantelín set de table



rutschhemmende Unterseite

slip resistant underside
antideslizante por debajo
dessous antiglisse

	cm		VE / unit	€ / pc.
60544	45 x 30	sand / sand	6	5,70
60545	45 x 30	bronze/schwarz / bronze/black	6	5,70
60546	45 x 30	bron/schwarz / silver/black	6	5,70



Tischset „CROCO“ placemat mantelín set de table



rutschhemmende Unterseite

slip resistant underside
antideslizante por debajo
dessous antiglisse

	cm		VE / unit	€ / pc.
60535	45 x 30	gold / gold	6	5,70
60536	45 x 30	kupfer / copper	6	5,70
60537	45 x 30	braun / brown	6	5,70

ENAMELWARE



Teller, flach „ENAMELWARE“

plate, flat
plato, plano
assiette, plat



	Ø cm	↑ cm	Farbe / Colour	€
40664	20	2		6,60
40665	24	2		7,80
40666	26	2		7,90



Teller, tief „ENAMELWARE“

plate, deep
plato, profunda
assiette, profonde



	Ø cm	↑ cm	ltr.	Farbe / Colour	€
40661	18	3,5	0,35		8,00
40662	22	3,5	0,60		8,80
40663	24	3,5	0,85		9,80



Schale „ENAMELWARE“

bowl
cuenco
bol



	cm	↑ cm	ltr.	Farbe / Colour	€
40667	16 x 12,0	3,5	0,20		7,90
40668	18 x 13,5	4,0	0,35		8,60



Schale „ENAMELWARE“

bowl
cuenco
bol



	cm	↑ cm	ltr.	Farbe / Colour	€
40669	28 x 23	4,5	1,9		14,20

ENAMELWARE



Henkelbecher „ENAMELWARE“

beaker
vaso coctelero
bol mélangeur



	Ø cm	↑ cm	ltr.	Farbe / Colour	€
40636	7	5	0,10		6,00
40632	9	8	0,35		7,20
40637	10	9	0,50		8,60



Henkelbecher „ENAMELWARE“

beaker
vaso coctelero
bol mélangeur



	Ø cm	↑ cm	ltr.	Farbe / Colour	€
40633	9	8	0,35		7,20



Henkelbecher „ENAMELWARE“

beaker
vaso coctelero
bol mélangeur



	Ø cm	↑ cm	ltr.	Farbe / Colour	€
40634	9	8	0,35		7,20



Henkelbecher „ENAMELWARE“

beaker
vaso coctelero
bol mélangeur



	Ø cm	↑ cm	ltr.	Farbe / Colour	€
40635	9	8	0,35		7,20



Schale „ENAMELWARE“

bowl
cuenco
bol



	Ø cm	↑ cm	ltr.	Farbe / Colour	€
40645	7,0	4,5	0,08		4,90
40646	8,0	3,5	0,08		4,90
40638	13,0	6,0	0,50		7,40
40647	16,5	4,5	0,45		6,20

Original WECK



Weck-Flaschen, 6er Set

Weck-bottles, 6 pcs.
Weck-botellas, set de 6
Weck-bouteilles, set de 6



6 Flaschen + 6 Deckel, ideal zum Servieren von Saft, Smoothie, Dressing und Saucen

6 bottles + 6 covers, ideal for serving juice, smoothie, dressing and sauces

6 botellas + 6 tapas, ideal para servir zumo, licuado, aliño y salsas

6 bouteilles + 6 couvercles, idéal pour servir de jus, smoothie, vinaigrette et sauces

	Ø cm	↑ cm	ltr.	pcs	€/ set
82307	6	14,5	0,25	6	15,10



Weck-Flaschen, 6er Set

Weck-bottles, 6 pcs.
Weck-botellas, set de 6
Weck-bouteilles, set de 6



6 Flaschen + 6 Deckel, ideal zum Servieren von Saft, Smoothie, Dressing und Saucen

6 bottles + 6 covers, ideal for serving juice, smoothie, dressing and sauces

6 botellas + 6 tapas, ideal para servir zumo, licuado, aliño y salsas

6 bouteilles + 6 couvercles, idéal pour servir de jus, smoothie, vinaigrette et sauces

	Ø cm	↑ cm	ltr.	pcs	€/ set
82308	6	19	0,5	6	16,70



Weck-Flaschen, 6er Set

Weck-bottles, 6 pcs.
Weck-botellas, set de 6
Weck-bouteilles, set de 6



6 Flaschen + 6 Deckel, ideal zum Servieren von Saft, Smoothie, Dressing und Saucen

6 bottles + 6 covers, ideal for serving juice, smoothie, dressing and sauces

6 botellas + 6 tapas, ideal para servir zumo, licuado, aliño y salsas

6 bouteilles + 6 couvercles, idéal pour servir de jus, smoothie, vinaigrette et sauces

	Ø cm	↑ cm	ltr.	pcs	€/ set
82309	6	25,5	1,0	6	20,00

GLASSES



82239 370 ml

82240 580 ml



Sturzform

Weck-Gläser mit Deckel, 2er Set

Weck-glasses with lid, 2 pcs.
Weck tarros de vidrio con tapa, set de 2
Weck verrines avec couvercle, set de 2

2 Gläser + 2 Edelstahldeckel

2 glasses + 2 stainless steel lids

2 tarros + 2 tapas de acero inoxidable

2 verrines + 2 couvercles en acier inox



	Ø cm	↑ cm	ltr.	pcs	€/ set
82239	11	7,5	0,37	2	19,00
82240	11	11	0,58	2	21,60



Edelstahldeckel für Weck-Gläser

stainless steel lid for Weck-glasses
tapas de acero inoxidable por Weck tarros
couvercles en acier inox pour Weck verrines



	Ø cm	↑ cm		€
82360	10,5	2	82239, 82240, 82346, 82347	6,20



82241 370 ml

82242 580 ml



Sturzform

Weck-Gläser mit Deckel, 2er Set

Weck-glasses with lid, 2 pcs.
Weck tarros de vidrio con tapa, set de 2
Weck verrines avec couvercle, set de 2

2 Gläser + 2 klappbare Edelstahldeckel

2 glasses + 2 foldable stainless steel lids

2 tarros + 2 tapas plegables de acero inoxidable

2 verrines + 2 couvercles pliables en acier inox



	Ø cm	↑ cm	ltr.	pcs	€/ set
82241	11	7,5	0,37	2	20,00
82242	11	11	0,58	2	24,00



klappbarer Edelstahldeckel für Weck-Gläser

foldable stainless steel lid for Weck-glasses
tapa plegable de acero inoxidable por Weck tarros
couvercle pliable en acier inox pour Weck verrines



	Ø cm	↑ cm		€
82361	10,5	4,5	82241, 82242, 82346, 82347	7,40

**Weck-Gläser mit Deckel, 2er Set**

Weck-glasses with lid, 2 pcs.

Weck tarros de vidrio con tapa, set de 2

Weck verrines avec couvercle, set de 2

2 Gläser + 2 Deckel aus Buchenholz

2 glasses + 2 beech wood lids

2 tarros + 2 tapas de madera de haya

2 verrines + 2 couvercles en bois de hêtre



	Ø cm	↑ cm	ltr.	pcs	€ / set
82243	11	7,5	0,37	2	14,60
82244	11	11	0,58	2	17,00

**Holzdeckel für Weck-Gläser**

wooden lid for Weck-glasses

tapas de madera por Weck tarros

couvercles en bois pour Weck verrines



	Ø cm	↑ cm	fits to	€
82362	11	2	82243, 82244, 82346, 82347	5,00

**Weck-Gläser mit Deckel, 12er Set**

Weck-glasses with lid, 12 pcs.

Weck tarros de vidrio con tapa, set de 12

Weck verrines avec couvercle, set de 12

12 Gläser + 12 Deckel aus Buchenholz

12 glasses + 12 beech wood lids

12 tarros + 12 tapas de madera de haya

12 verrines + 12 couvercles en bois de hêtre



	Ø cm	↑ cm	ltr.	pcs.	€ / set
82245	6	7	0,14	12	50,00

**Weck-Gläser mit Deckel, 12er Set**

Weck-glasses with lid, 12 pcs.

Weck tarros de vidrio con tapa, set de 12

Weck verrines avec couvercle, set de 12

12 Gläser + 12 Deckel aus Buchenholz

12 glasses + 12 beech wood lids

12 tarros + 12 tapas de madera de haya

12 verrines + 12 couvercles en bois de hêtre



	Ø cm	↑ cm	ltr.	pcs.	€ / set
82246	7	8	0,22	12	50,00

**Holzdeckel für Weck-Gläser, 12er Set**

wooden lid for Weck-glasses, 12 pcs.

tapas de madera por Weck tarros, set de 12

couvercles en bois pour Weck verrines, set de 12



	Ø cm	↑ cm	fits to	pcs.	€ / set
82363	7	1,5	82245, 82246, 82307, 82308, 82309, 82310, 82312, 82314, 82316, 82370, 82371	12	32,00

GLASSES



Weck-Gläser mit Deckel, 12er Set

Weck-glasses with lid, 12 pcs.
Weck tarros de vidrio con tapa, set de 12
Weck verrines avec couvercle, set de 12



12 Gläser + 12 Deckel

12 glasses + 12 covers

12 vasos + 12 tapas

12 verrines + 12 couvercles

	Ø cm	↑ cm	ltr.	pcs	€/ set
82310	6	5,5	0,08	12	25,30
82312	6	7,0	0,14	12	27,60
82314	6	8,0	0,16	12	27,60
82345	9	6	0,20	12	27,60

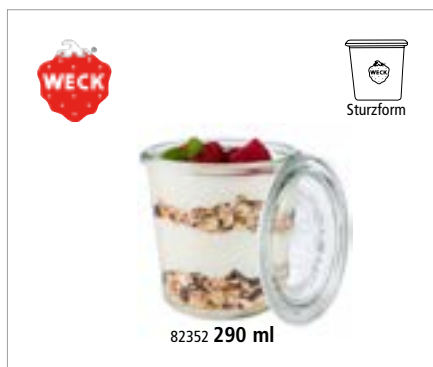

Weck-Gläser mit Deckel, 6er Set

Weck-glasses with lid, 6 pcs.
Weck tarros de vidrio con tapa, set de 6
Weck verrines avec couvercle, set de 6



6 Gläser + 6 Deckel

6 glasses + 6 covers

6 tarros + 6 tapas

6 verrines + 6 couvercles

	Ø cm	↑ cm	ltr.	pcs	€/ set
82352	9	9	0,29	6	15,10



Weck-Gläser mit Deckel, 3er Set

Weck-glasses with lid, 3 pcs.
Weck tarros de vidrio con tapa, set de 3
Weck verrines avec couvercle, set de 3



3 Gläser + 3 Deckel

3 glasses + 3 covers

3 vasos + 3 tapas

3 verrines + 3 couvercles

	Ø cm	↑ cm	ltr.	pcs	€/ set
82346	11	7,5	0,37	3	8,50



Weck-Gläser mit Deckel, 2er Set

Weck-glasses with lid, 2 pcs.
Weck tarros de vidrio con tapa, set de 2
Weck verrines avec couvercle, set de 2



2 Gläser + 2 Deckel

2 glasses + 2 covers

2 vasos + 2 tapas

2 verrines + 2 couvercles

	Ø cm	↑ cm	ltr.	pcs	€/ set
82347	11	11	0,58	2	7,50

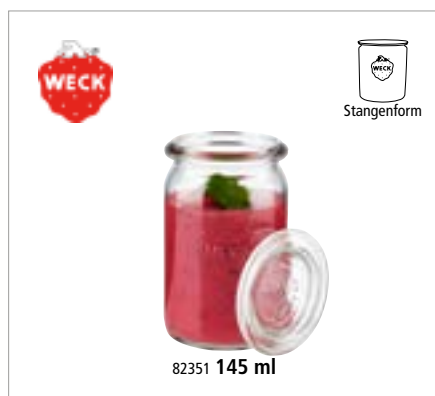
**Weck-Gläser mit Deckel, 12er Set**

Weck-glasses with lid, 12 pcs.

Weck tarros de vidrio con tapa, set de 12

Weck verrines avec couvercle, set de 12

12 Gläser + 12 Deckel

12 glasses + 12 covers

12 tarros + 12 tapas

12 verrines + 12 couvercles



	Ø cm	↑ cm	ltr.	pcs	€/ set
82351	5,5	9	0,145	12	24,80

**Weck-Gläser mit Deckel, 12er Set**

Weck-glasses with lid, 12 pcs.

Weck tarros de vidrio con tapa, set de 12

Weck verrines avec couvercle, set de 12

12 Gläser + 12 Deckel

12 glasses + 12 covers

12 vasos + 12 tapas

12 verrines + 12 couvercles



	Ø cm	↑ cm	ltr.	pcs	€/ set
82350	5,5	6	0,075	12	22,70
82316	7	8,0	0,22	12	27,60

**Weck-Gläser mit Deckel, 6er Set**

Weck-glasses with lid, 6 pcs.

Weck tarros de vidrio con tapa, set de 6

Weck verrines avec couvercle, set de 6

6 Gläser + 6 Deckel

6 glasses + 6 covers

6 tarros + 6 tapas

6 verrines + 6 couvercles

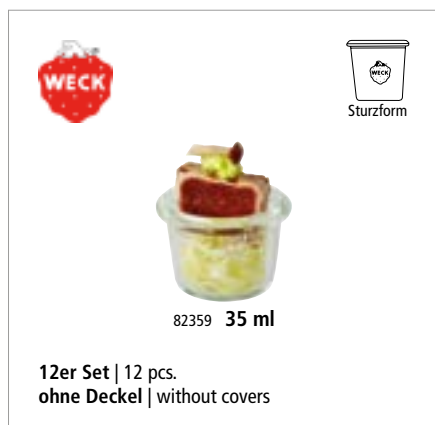

	Ø cm	↑ cm	ltr.	pcs	€/ set
82354	11	9	0,58	6	17,70

**Gourmetgläser, 12er Set**

gourmet glasses, 12 pcs.

tarros gourmet, set de 12

verres gourmet, set de 12



	Ø cm	↑ cm	ltr.	pcs	€/ set
82359	5	3,5	0,035	12	11,30
82370	6	5,5	0,08	12	15,40
82371	6	8,0	0,16	12	16,50





Serviergestell „WECK“

serving stand
expositor
présentoir
ohne Gläser
without glasses
sin vasos
sans verrines



	Ø cm	↑ cm		€
33246	22	59	12 x Ø 6 cm	94,00

passende Gläser / matching glasses / vasos a juego / verrines approprié



	Ø cm	↑ cm	ltr.	pcs	€ / set
82310	6	5,5	0,08	12	25,30
82312	6	7,0	0,14	12	27,60
82314	6	8,0	0,16	12	27,60



Weck-Frischhaltedeckel, 5er Set

airtight cover, 5 pcs.
tapa hermética, set de 5
couvercle hermétique, set de 5
für Rundrandgläser Ø 6 cm, 5er Set
for Ø 6 cm glasses, 5 pcs. set
para vasos Ø 6 cm, set de 5
pour verrines Ø 6 cm, set de 5



	Ø cm		pcs.	€ / set
82338	7		5	2,45



Gummidichtringe, 10er Set

rubber washer, 10 pcs.
juntas de goma, set de 10
joints de caoutchouc, set de 10
für Deckel der Weck-Gläser, im Beutel verpackt
for covers of Weck-glasses, packed in a bag
para las tapas de los tarritos Weck, empaquetado en una bolsa
pour la fermeture des verrines Weck, emballé dans un sac

	fits to		pcs.	€ / set
82318	82307, 82308, 82309, 82310, 82312, 82314, 82316		10	1,30
82394	82345		10	1,30
82395	82346, 82347		10	1,40



8er Set Deckel-Klammer für 4 Weck-Gläser

8 pcs. cover clamps for 4 Weck-glasses
8 abrazaderas para 4 vasitos Weck
8 agrafes pour 4 verrines Weck

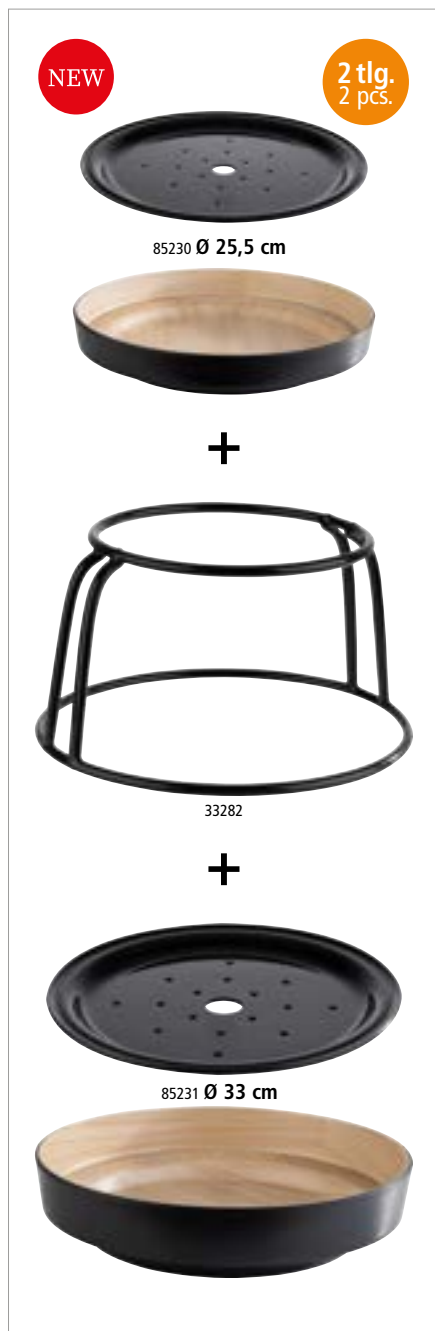

		pcs.	€ / set
82319		8	2,50

**Schale, 2-teilig „FRIDA“**

bowl, 2 pcs.
cuenca, set de 2
bol, set de 2



inklusive Abtropfeinsatz
including drip tray
con bandeja recogegotas
avec égouttoir

	Ø cm	↑ cm		€
85230	25,5	6		27,00
85231	33,0	6		46,00

Buffetständer

buffet stand
soporte para buffet
présentoir buffet



Metall, mit schwarzer Antirutschbeschichtung, für Schalen Nr. 85230, 85231

metal, with black anti-slide coating, for bowls no. 85230, 85231

metal, con revestimiento antideslizante negro, para cuencos 85230, 85231

métal, avec revêtement antidérapant noir, pour bols 85230, 85231

	Ø cm	↑ cm		€
33282	23 / 30,5	17		42,00

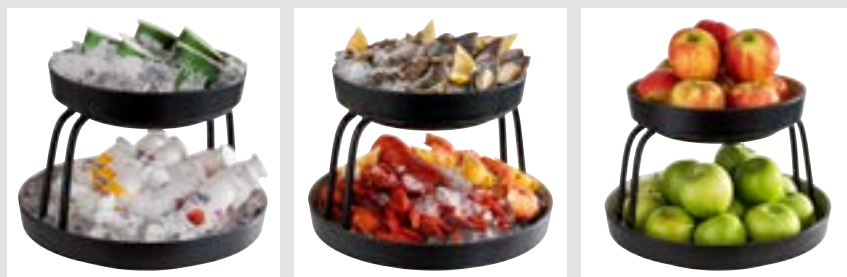

Präsentationsmöglichkeit
presentation example



mit Abtropfeinsatz
with drip tray



Topf darf nicht erhitzt werden!
Topf ist nicht zum Kochen geeignet!

Servier-Muscheltopf

serving mussel pot
mejillonera para servir
casserole à moules pour servir

schwarz emailliertes Stahlblech, mit Edelstahlrand

black enamelled steel, stainless steel rim

hierro esmaltado negro, borde inox

acier émaillé noir, bord inox



	Ø cm	↑ cm	Topf / pot ltr.	Deckel / lid ltr.	€
00623	13,5	9,0	0,75	0,60	10,80
00625	18,0	12,0	2,60	1,40	15,00
00626	20,0	13,0	3,30	1,60	17,00
00627	24,0	13,5	5,20	2,70	20,00

CAKE STANDS



Servier- und Tortenplatte „CASUAL“
 cake plate
 porta pasteles
 présentoir à gâteaux



	Ø cm	↑ cm	€
83890	31	8	28,60
83891	31	16	36,00
	cm	↑ cm	€
83892	31 x 31	8	32,00
83893	31 x 31	16	39,00



Servier- und Tortenplatte
 cake stand
 porta pasteles
 présentoir à gâteaux



Rand fixiert die Haube, mit Antirutschfüßchen
 carved edge fixes the cover, with non-slip feet
 ranura para fijar bien la campana, con pies antideslizantes
 bord rainuré pour maintenir ferme la cloche, avec pieds antidérapants



	Ø cm	↑ cm	Farbe / Colour	fits to cover	€
00468	31	3,5	White	06520	18,40
00469	31	3,5	Black	06520	18,40



Servier- und Tortenplatte
 cake stand
 porta pasteles
 présentoir à gâteaux



Eichenholz geölt, mit Safrinne
 oak wood oiled, with juice groove
 madera de roble aceitada, mit Safrinne
 bois de chêne huilé, mit Safrinne

	Ø cm	↑ cm	€
00818	32	2,0	30,00

passende Hauben / suitable for covers / campanas adecuadas / cloches appropriées

	Ø cm	↑ cm	€
06520	30	22	40,00
06510	30	11,5	5,90

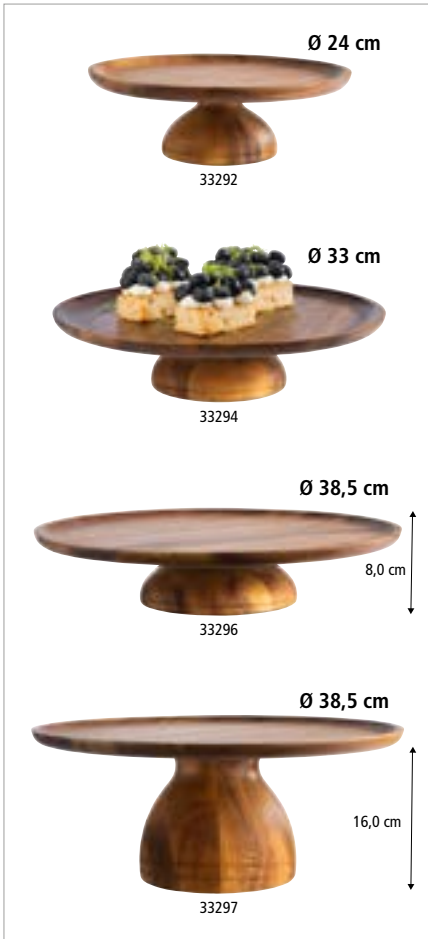

Servier- und Tortenplatte „ACACIA“

cake stand
porta pasteles
présentoir à gâteaux

Akazienholz geölt, möbelschonende Unterseite
acacia wood oiled, furniture-friendly underside
madera de acacia aceitada, con base anti rayaduras
bois d'acacia huilé, avec revêtement antirayures



	Ø cm	↑ cm		€
33292	24,0	8		50,00
33293	24,0	16		65,00
33294	33,0	8		70,00
33295	33,0	16		96,00
33296	38,5	8		86,00
33297	38,5	16		112,00

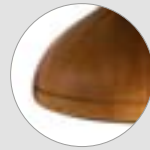

mit Rille
with groove

Frischhaltehaube / cover / campana / cloche



	Ø cm	↑ cm	fits to	€
06519	21	17	33292, 33293	30,00
06520	30	22	33294, 33295	40,00
06521	36	27	33296, 33297	74,00



drehbar
rotating

Servier- und Tortenplatte

cake stand
porta pasteles
présentoir à gâteaux

matt poliert, drehbar, möbelschonende Unterseite
matt polished, rotating, furniture-friendly underside
acabado pulido satinado, giratorio, base revestida de goma para no rallar el mobiliario
poli satiné, plateau tournant, avec revêtement antirayures



	Ø cm	↑ cm		€
00463	30,5	9		47,00



Servier- und Tortenplatte

cake stand
porta pasteles
présentoir à gâteau

matt poliert / matt polished / acabado efecto satinado / poli mat poli mat



	Ø cm	↑ cm		€
00046	31	3		15,00

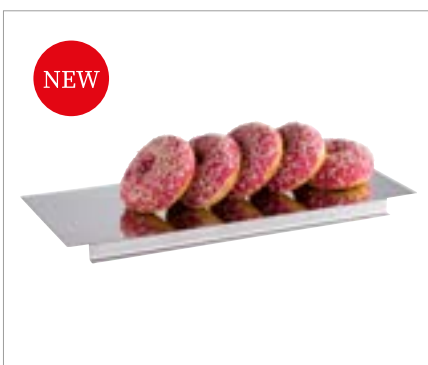

Auslagen- / Kuchenplatte

display / cake plate
expositor / plato para tartas
présentoir / assiette à gâteau
ideale Größe für Baumkuchen / Stollen
ideal size for Baumkuchen / Stollen
tamaño ideal para Baumkuchen / Stollen
taille idéale pour Baumkuchen / Stollen



	cm	↑ cm		€
00047	40 x 16	2,5		14,95

SUPER DOME



06525 Ø 30 cm

Frischhaltehaube „SUPER DOME“

cover
campana
cloche



schwere, glasklare Qualität
stable, crystal clear quality
muy resistente y transparencia cristalina
haute résistance et transparence

	Ø cm	↑ cm	€
06525	30	40	74,00

passende Servier-/Tortenplatten / suitable cake stands / porta pasteles compatibles /
présentoirs à gâteaux compatibles

	Ø cm	↑ cm	fits to	Farbe / Colour	€
00468	31,0	3,5	06525		18,40
33294	33,0	8,0	06525		70,00
33295	33,0	16,0	06525		96,00

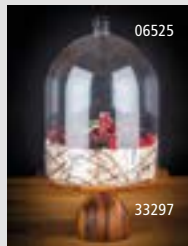

Präsentationsmöglichkeiten
presentation examples



Ø 21cm

tray
84942

Frischhaltehaube

cover
campana
cloche



schwere, glasklare Qualität
stable, crystal clear quality
calidad estable y transparencia cristalina
qualité stable et clarté cristalline

	Ø cm	↑ cm	fits to	€
06519	21	17	84941, 84942	30,00
06520	30	22	85034, 84177, 83891, 83890, 83884, 998, 975, 469, 468, 463, 462, 46	40,00
06521	36	27	84945, 84946	74,00

GRAVY BOATS



Sauciere „PROFI“

gravy boat
salsera
saucière

hochglanzpoliert, extra schwere Qualität
mirror polished, high quality
pulido brillante, alta calidad, base pesada
poli brillant, belle qualité, pied pesant



	cm	↑ cm	ltr.	€
40208	13 x 6,0	9,0	0,075	6,60
40204	16 x 7,5	9,0	0,125	7,60
40205	19 x 9,0	13,0	0,25	9,90
40206	22 x 10,5	13,5	0,4	12,00



Sauciere „ECO“

gravy boat
salsera
saucière

hochglanzpoliert
mirror polished
pulido brillante
poli brillant



	cm	↑ cm	ltr.	€
40200	18,0 x 7,5	7,0	0,10	4,90
40203	21,5 x 9,5	8,5	0,15	5,70
40201	23,5 x 10,0	10,0	0,20	6,00
40202	23,5 x 12,0	12,0	0,45	7,40

PLATE TRAYS



Thermo-Sauciere

insulated sauce boat
salsera isotérmica
saucière thermique



doppelwandig, Klappdeckelverschluss, Einhandbedienung

double wall, hinged cover, one-hand operation

doble pared, tapa con bisagra, se maneja con 1 mano

double paroi, couvercle avec charnière, usage 1 main

	cm	↑ cm	ltr.	€
40207	19 x 12,5	13	0,4	16,00



Glocke

cloche / dome cover
campana esférica
cloche demi-sphère



außen hochglanzpoliert, innen matt poliert, mit verchromten Griff

outside mirror polished, inside matt polished, with chromeplated handle

exterior pulido brillante, interior pulido mate, pomo cromado

extérieur poli brillant, intérieur poli mat, buton chromé

	Ø cm	↑ cm	€
35734	29	18	56,00



Platzteller

plate tray
bajo plato
assiette de présentation



hochglanzpoliert, mit Fadendekor

mirror polished, with line edge

pulido brillante, con un filo en relieve

poli brillant, filet relief

	Ø cm	€
35730	30,5	15,20
36233	33,0	21,00



Platzteller

plate tray
bajo plato
assiette de présentation



hochglanzpoliert, mit Perlrand

mirror polished, with pearl edge

acabado pulido brillante, con borde aperlado

poli brillant, bord perlé

	Ø cm	€
35720	30,5	15,40
36323	33,0	18,20



Tischkrümelentferner

crumber
recogemigas
ramasse-miettes



matt poliert, geschliffene Edelstahlkante

matt polished, flat grinded stainless steel edge

pulido mate, borde plano de acero inoxidable rectificad

poli mat, bord plat rectifié en acier inox

	cm	↑ cm	€
00581	19,0 x 4,5	1	8,00



Untersetzer, 6er Set

coaster, 6 pcs.
posavasos, set de 6
plateau sous-verre, set de 6

hochglanzpoliert, schwere Ausführung, Rand eingerollt
mirror polished, heavy quality, rolled edge
pulido brillante, alta calidad, borde redondeado
poli brillant, bord rond, qualité extra



	Ø cm	pcs.	€ / set
35711	10	6	22,00
35912	12	6	17,00



Untersetzer, 6er Set

coaster, 6 pcs.
posavasos, set de 6
plateau sous-verre, set de 6



	Ø cm	pcs.	€ / set
35716	11	6	17,40



Serviettenringe, 4er Set

napkin rings, 4 pcs.
servilleteros, set de 4
anneaux porte-serviette, set de 4



	Ø cm	↑ cm	pcs.	€ / set
04446	4,5	2,5	4	8,40



Rechnungstablett

bill presenter
porta cuenta
porte-addition
mit Klemme für Rechnung
with clip for bill
con clip para la nota
avec clip pour la note



	cm	↑ cm	€
30110	17 x 11	1,0	6,30



Rechnungstablett





bill presenter
porta cuenta
porte-addition
mit Klemme für Rechnung
with clip for bill
con clip para la nota
avec clip pour la note







	cm	↑ cm	€
30108	20 x 12	0,5	2,40







Besteckkorb „ECONOMIC“
 cutlery dispenser
 dispensador de cubiertos
 corbeille à couverts









	Ø cm	↑ cm	Farbe / Colour	€
40130	12	15		4,80
40007	12	15		4,80
40012	12	15		4,80
40013	12	15		4,80





Besteckkorb „ECONOMIC“
 cutlery dispenser
 dispensador de cubiertos
 corbeille à couverts

	cm	↑ cm	Farbe / Colour	€
40131	27 x 10	4,5		4,80
40009	27 x 10	4,5		4,80
40010	27 x 10	4,5		4,80
40011	27 x 10	4,5		4,80



Besteckständer
 cutlery basket
 porta cubiertos
 porte-couverts

Behälter aus Edelstahl, matt poliert
 container made of stainless steel, matt polished
 contenedor de acero inoxidable, pulido mate
 conteneur en acier inox, poli mat

	Ø cm	↑ cm	€
11921	10	10,0	8,60
11922	12	13,5	11,20



Besteckbehälter „ELEMENT“

cutlery bin
recipiente para cubiertos
récipients pour couverts

mit Abflussloch, mit Besteck Logo, Bodeneinlagen aus Silikon zum Schonen des Bestecks, möbelschonende Unterseite

with drain hole, with cutlery logo, silicone floor inserts for saving the points of knives, furniture-friendly underside

con orificio de drenaje, con logotipo de cubertería, soporte de silicona para proteger las puntas de los cuchillos, con base antirrayaduras

avec le trou de drainage, avec le logo de coutellerie, insert de silicone pour protéger les pointes des couteaux, avec base revêtue antirayures



	Ø cm	↑ cm	€
00018	11	14	17,00



Besteckköcher

cutlery basket
cesta para cubiertos
corbeille à couverts

Kunststoff weiß / white plastic / plástico blanco / plastique blanc



	Ø cm	↑ cm	€
11998	9,5	13,5	2,90

matt poliert / matt polished / pulido mate / poli mat

	Ø cm	↑ cm	€
11999	9,5	13,5	8,60



Tischreste-/ Besteckbehälter „TOP CHROME“

table waste bin / cutlery bin
papelera de sobremesa / recipiente para cubiertos
poubelle de table / récipients pour couverts

mit verchromten Rand / with chrome plated ring / con anillo cromado / avec bord chromé



	Ø cm	↑ cm	ltr.	Farbe / Colour	€
00025	13	15	1	White	8,00
00026	13	15	1	Black	8,00



Tischreste-/ Besteckbehälter „BASE CHROME“

table waste bin / cutlery bin
papelera de sobremesa / recipiente para cubiertos
poubelle de table / récipients pour couverts

mit verchromten Boden / with chrome bottom / con base cromada / avec base chromée



	Ø cm	↑ cm	ltr.	Farbe / Colour	€
00019	13	15	1,3	White	8,00
00020	13	15	1,3	Black	8,00



Tischreste-/ Besteckbehälter

table waste bin / cutlery bin
papelera de sobremesa / recipiente para cubiertos
poubelle de table / récipients pour couverts

mit verchromten Rand, inklusive herausnehmbarem Einteiler (4 Fächer)

with chrome plated ring, including devider (4 chambers)

con anillo cromado, incluyendo devider (4 cámaras)

avec bord chromé, y compris devider (4 chambres)



	cm	↑ cm	Farbe / Colour	€
00016	14 x 14	16	Black	26,00



Table Caddy „COUNTRY STYLE“

table barrel
caddy de mesa
caddy de table



cooler Country-Style, nicht für den direkten Kontakt mit Lebensmittel verwendbar

condiment and cutlery holders or even for food presentation, the mini barrels should not come into contact with food, they should be lined with our greaseproof paper

estilo campestre, no aptos para el contacto directo con alimentos, sólo usando papel alimenticio

de style champêtre, pas de contact direct avec aliments, seulement en utilisant papier alimentaire

	Ø cm	↑ cm	€
11930	17,5	8,5	21,00
11931	11,5	14,0	21,00



Tischrestebehälter

table garbage bin
papelera de sobremesa
poubelle de table



	Ø cm	↑ cm	ltr.	Farbe / Colour	€
02038	11	14	0,9		3,40
02039	11	14	0,9		3,40



Tischrestebehälter

table garbage bin
papelera de sobremesa
poubelle de table



	Ø cm	↑ cm	ltr.	€
00311	14	15	1,2	4,20



Tischrestebehälter

table garbage bin
papelera de sobremesa
poubelle de table



Kunststoff weiß / granit, abnehmbarer Schwingdeckel

white plastic, swing cover, cover removable

plástico blanco/granito, tapa basculante desmontable

plastique blanc/gris chiné, couvercle basculant démontable

	Ø cm	↑ cm	ltr.	€
00031	12	18	1,4	6,60



Tischrestebehälter

table garbage bin
papelera de sobremesa
poubelle de table



matt poliert, abnehmbarer Schwingdeckel, mit Bajonettverschluss

matt polished, swing cover, cover removable, with bayonet lock

pulido mate, tapa basculante desmontable, con cierre de bayoneta

poli mat, couvercle basculant démontable, avec fermeture à baïonnette

	Ø cm	↑ cm	ltr.	€
00029	12	17	1,2	19,00
00027	10	13	0,7	13,90

MENU HOLDERS



zum Einschieben der Speisekarten – schneller Austausch jederzeit möglich!
for inserting the menus - quick exchange possible at any time!



Der Kartenhalter ist völlig unkompliziert zu handhaben, denn er verfügt über eine Vorrichtung, in die die Karten einfach eingeschoben und schnell ausgetauscht werden können.

The menu holder is completely uncomplicated to handle, because it has a device into which the cards can simply be inserted and quickly exchanged.

El uso del porta menús es totalmente sencillo, ya que dispone de un dispositivo en el que simplemente se introducen las tarjetas y se intercambian rápidamente.

L'utilisation du porte-cartes est très simple, car il dispose d'un dispositif dans lequel les cartes peuvent être simplement insérées et rapidement échangées.



Kartenhalter 2-teilig

menu holder, 2 pcs.
porta menús, set de 2
porte-cartes, set de 2

Fuß aus Edelstahl, Menühalter aus Acryl
stainless steel base, menu holder made of acrylic
base de acero inoxidable, porta menús acrílico
base en acier inox, porte-cartes en acrylique



	cm	↑ cm			€ / set
71521	10,5 x 7	17	stainless steel		11,00
71527	10,5 x 7	17	black		11,00



Kartenhalter 2-teilig

menu holder, 2 pcs.
porta menús, set de 2
porte-cartes, set de 2

Fuß aus Edelstahl, Menühalter aus Acryl
stainless steel base, menu holder made of acrylic
base de acero inoxidable, porta menús acrílico
base en acier inox, porte-cartes en acrylique



	cm	↑ cm			€ / set
71522	15 x 7	23	stainless steel		13,60
71528	15 x 7	23	black		13,60



Kartenhalter 2-teilig

menu holder, 2 pcs.
porta menús, set de 2
porte-cartes, set de 2

Fuß aus Edelstahl, Menühalter aus Acryl
stainless steel base, menu holder made of acrylic
base de acero inoxidable, porta menús acrílico
base en acier inox, porte-cartes en acrylique



	cm	↑ cm			€ / set
71523	21 x 7	32	stainless steel		16,00
71529	21 x 7	32	black		16,00

MENU HOLDERS

NEW



**2 tlg.
2 pcs.**

71520

Mini Staffelei, 2 teilig

easel mini, 2 pcs.
caballete mini, set de 2
chevale mini, set de 2



Ständer aus Akazienholz, Schild kann senkrecht oder waagrecht verwendet werden

acacia wood stand, sign can be used vertically or horizontally

soporte de madera de acacia, el cartel se puede utilizar vertical u horizontalmente

support en bois d'acacia, le panneau peut être utilisé verticalement ou horizontalement

	cm	↑ cm	€/ set
71520	13,5 x 10,0	19	8,90
71531 NEW	19,5 x 15,0	24	9,90



waagrecht
horizontal



senkrecht
vertical



71490 Kreide-Marker
chalk marker

Inhalt ohne Stift
content without pen

**2 tlg.
2 pcs.**



71496



71497

Kartenhalter „ELEMENT“, 2 teilig

menu holder, 2 pcs.
soporte de tarjeta de menú, set de 2
porte-cartes de menu, set de 2



Fuß aus Beton, Menühalter aus Acryl

concrete base, acrylic menu sign / holder

base de hormigón, letrero de menú acrílico

socle en béton, plaque de menu en acrylique

	cm	↑ cm	€/ set
71496	11,5 x 4,5	10	13,10
71497	15,5 x 6,5	26	20,90



**6 Stck. Halter
12 Stck. Karten**

Kartenhalter-Set

card holder set
portatarjetas, set
porte-cartes, set



18-teilig: 6 Kartenhalter 4 x 2,5 cm + 12 Kunststoff-Beschriftungskarten 10 x 6 cm

18 pcs.: 6 card holder 4 x 2,5 cm + 12 plastic cards of inscription 10 x 6 cm

set de 18: 6 soportes 4 x 2,5 cm + 12 tarjetas de plástico 10 x 6 cm

set de 18: 6 supports 4 x 2,5 cm + 12 étiquettes en plastique 10 x 6 cm

	cm	€/ set
00022	4 x 2,5	13,30



Kartenhalter, 4er Set

table stands, 4 pcs.
portatarjetas, set de 4
porte-cartes, set de 4

hochglanzpoliert, inklusive 20 schwarze Beschriftungskarten aus Polypropylen

mirror polished, including 20 black cards made of polypropylene

pulido brillante, incluye 20 tarjetas negras de polipropileno

poli miroir, inclut 20 étiquettes noires en polypropylène



	Ø cm	↑ cm	pcs.	Farbe / Colour	€/ set
71510	5	10,5	4	stainless steel	20,90
71513	5	15,5	4	stainless steel	22,10
71516	5	20,5	4	stainless steel	24,10

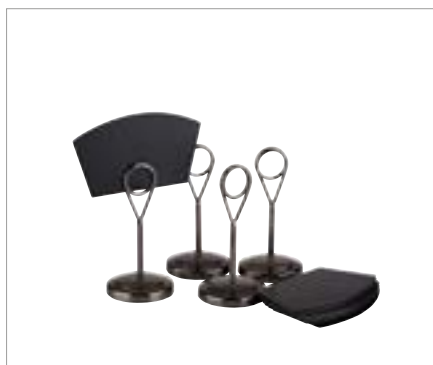

Kartenhalter, 4er Set

table stands, 4 pcs.
portatarjetas, set de 4
porte-cartes, set de 4

hochglanzpoliert, inklusive 20 schwarze Beschriftungskarten aus Polypropylen

mirror polished, including 20 black cards made of polypropylene

pulido brillante, incluye 20 tarjetas negras de polipropileno

poli miroir, inclut 20 étiquettes noires en polypropylène



	Ø cm	↑ cm	pcs.	Farbe / Colour	€/ set
71512	5	10,5	4	gunmetal	24,10



Beschriftungskarten, 10er Set

designation cards, 10 pcs.
tarjetas, set de 10
étiquettes, set de 10



	cm	✂ mm	pcs.	€
00037	7,5 x 5	0,4	10	5,20



Bankettkartenständer

menu stand / table number
porta-etiqueta o carta de sobremesa
porte-étiquette de table, porte-menu, ou n° de table

hochglanzpoliert, schwere Qualität

mirror polished, heavy gauge

pulido brillante, alta calidad

poli brillant, belle qualité



	Ø cm	↑ cm	€
71460	7,5	18,5	8,90
71461	7,5	29	11,50



Tischkartenhalter, 4er Set

table stands, 4 pcs.
pinzas porta-etiquetas, set de 4
porte-étiquettes à pince, set de 4

hochglanzpoliert, schwerer Fuß, inklusive 20 weiße Beschriftungskarten

mirror polished, heavy foot, including 20 white labels

pulido brillante, incluye 20 etiquetas en blanco

poli brillant, inclut 20 étiquettes blanches



	Ø cm	↑ cm	pcs.	€/ set
00070	4	10	4	21,80

MENU HOLDERS



Tischaufsteller, 10er Set

table stands, 10 pcs.
caballes de mesa, set de 10
chevalets de table, set de 10



Ecken abgerundet

corners rounded
esquinas redondeadas
coins arrondies

	cm	↑ cm	pcs.	€/ set
00011	7,5 x 3,5	5	10	7,40
00012	10,5 x 6	6,5	10	8,50



Kartenhalter, 2er Set

card holder, 2 pcs.
soporte de mesa, set de 2
support de table, set de 2



inklusive 40 Beschriftungskarten, durch Magnete einfach zusammenklappbar

including 40 cards, easily foldable with magnets
incluye 40 tarjetas, fácil de plegar, con imanes
inclut 40 étiquettes, fácil à plier, avec aimants

	cm	↑ cm	pcs.	€/ set
00076	9 x 3	5,5	2	17,70



Kartenhalter, 2er Set

menu holder, 2 pcs.
porta cartas de mesa, set de 2
supports pour menu de table, set de 2



Rubberwood / rubber wood / madera de goma / bois d'hévéa

	cm	↑ cm	pcs.	€/ set
00023	8,5 x 6	4,5 / 8,5	2	8,30



Kartenhalter, 2er Set

menu holder, 2 pcs.
porta cartas de mesa, set de 2
porte-menus de table, set de 2



matt poliert
matt polished
pulido mate
poli mat

	cm	↑ cm	pcs.	€/ set
00021	8,5 x 4	4 / 8,5	2	9,70



Tischkartenhalter
 table stand
 soporte-carta para la mesa
 support pour menu de table
matt poliert
 matt polished
 pulido mate
 poli mat



	cm	↑ cm	pcs.	€
00030	8 x 7,0	2	1	3,10
00036	6 x 4,5	4	1	2,10



Kartenhalter-Set, 4er Set
 table stands, 4 pcs.
 portatarjetas, set de 4
 porte-cartes, set de 4
inklusive 30 Beschriftungskarten (15 x weiß + 15 x schwarz)
 including 30 labels (15 x white + 15 x black)
 incluye 30 tarjetas (15 x blanco + 15 x negro)
 inclut 20 étiquettes (15 x blanc + 15 x noir)



	cm	↑ cm	pcs.	€ / set
71492	3 x 3	3	4	8,90
71493	3 x 3	3	4	8,90
71494	3 x 3	12	4	9,70



Kartenhalter, 4er Set
 table stands, 4 pcs.
 soportes de mesa, set de 4
 upport de table, set de 4
inklusive 20 weiße Beschriftungskarten ca. 10 x 8 cm
 including 20 white labels 10 x 8 cm
 incluye 20 etiquetas blancas 10 x 8 cm
 20 étiquettes blanches incluses 10 x 8 cm



	cm	↑ cm	pcs.	Farbe / Colour	€ / set
00074	3 x 3	12	4		9,70



Kartenhalter, 4er Set
 table stands, 4 pcs.
 soportes de mesa, set de 4
 support de table, set de 4
Rubberwood, inklusive 20 weiße Beschriftungskarten ca. 10 x 8 cm
 rubber wood, including 20 white labels 10 x 8 cm
 madera de goma, incluye 20 etiquetas blancas 10 x 8 cm
 bois d'hévéa, 20 étiquettes blanches incluses 10 x 8 cm



	cm	↑ cm	pcs.	Farbe / Colour	€ / set
00700	2,5 x 2,5	12	4		8,20

MENU HOLDERS



Kartenhalter „WÜRFEL“, 4er Set

table stands, 4 pcs.
soporte de mesa, set de 4
porte-étiquettes, set de 4

inklusive 20 weiße Beschriftungskarten ca. 10 x 8 cm, mehrfach beschriftbar

including 20 white labels 10 x 8 cm, multiple inscribable
incluye 20 etiquetas blancas 10 x 8 cm, inscribable múltiple
20 étiquettes blanches incluses 10 x 8 cm, inscriptible multiple

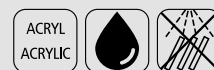

	cm	pcs.	€/ set
00078	3 x 3 x 3	4	11,00



Kartenhalter „ZYLINDER“, 4er Set

table stands, 4 pcs.
soporte de mesa, set de 4
porte-étiquettes, set de 4

inkl. 20 weiße Beschriftungskarten ca. 10 x 8 cm, mehrfach beschriftbar

incl. 20 white labels 10 x 8 cm
incluye 20 etiquetas blancas 10 x 8 cm
20 étiquettes blanches incluses 10 x 8 cm



	cm	pcs.	€/ set
00079	3 x 3 x 3	4	11,00



Tafelhalter / Schild

slate sign
caballete de mesa, pizarra
plaque signalétique avec support



	cm	↑ cm	pcs.	€
00060	12 x 4	7	1	7,80



Kartenhalter, 2er Set „KLAMMER“

table stand, 2 pcs.
soporte de mesa, set de 2
support de table, set de 2

Kiefernholz, inklusive 30 Beschriftungskarten ca. 10 x 8 cm (15 x weiß, 15 x schwarz)

pine wood, including 30 cards 10 x 8 cm (15 x white, 15 x black)
madera de pino, incluye 30 tarjetas 10 x 8 cm (15 x blanco, 15 x negro)
bois de pin, inclut 30 étiquettes 10 x 8 cm (15 x blanc, 15 x noir)



	cm	↑ cm	pcs.	Farbe / Colour	€/ set
71487	4 x 2,5	10	2		13,70
71489	4 x 2,5	10	2		13,70

Beschriftungskarten, 50 Stück / designation cards, 50 pcs. set
cartelitos de designación, 50 piezas / cartes de désignation, 50 pièces

	cm	pcs.	Farbe / Colour	fits to	€/ set
71498	10 x 8	50		71487, 71489	4,80
71499	10 x 8	50		71487, 71489	4,80



Kartenhalter, 2er Set

table stands, 2 pcs.
portatarjetas, set de 2
porte-cartes, set de 2



inklusive 30 Beschriftungskarten ca. 10 x 8 cm (15 x weiß + 15 x schwarz)

including 30 labels 10 x 8 cm (15 x white + 15 x black)

incluye 30 tarjetas 10 x 8 cm (15 x blanco + 15 x negro)

inclut 20 étiquettes 10 x 8 cm (15 x blanc + 15 x noir)

	cm	↑ cm	pcs.	€ / set
71495	8 x 3,5	6	2	8,20



Tischkartenhalter „PROFI“

table stand
soporte de mesa
support de table



	cm	↑ cm	€
40425	9,5 x 7,5	13,5	9,20



Tischkartenhalter

table stand
soporte de mesa
support de table



möbelschonende Unterseite

non-scratching undersurface

con base antirrayaduras

avec revêtement antirayures

	cm	↑ cm	€
00071	14 x 5,5	14	17,20

MENU HOLDERS



71470

Schilderhalter „FLEXIBEL“

sign holder
soporte para cartelito
support pour menu de table



biegsamer Draht mit zwei Klemmen, extrem flexibel, die Klemmen lassen sich weit öffnen
bedable metal coil adds visual interest, two metal clip open
metal cromado flexible, 2 pinzas con gran apertura
métal chromé, flexible, 2 pinces à grande ouverture

	→ cm		€
71470	12	ohne Schilder / without signs sin cartelitos / sans étiquette	3,70
71471	23	ohne Schilder / without signs sin cartelitos / sans étiquette	4,40
71480	12	inkl. 10 Schilder 11879 / incl. 10 signs 11879 con 10 cartelitos 11879 / avec 10 étiquettes 11879	9,30

Schilder, 10er Set / signs, 10 pcs. / set de 10 cartelitos / set de 10 étiquettes

	cm	€ / set
11879	7,7 x 5,2	5,20
12879	5,0 x 3,0	4,90

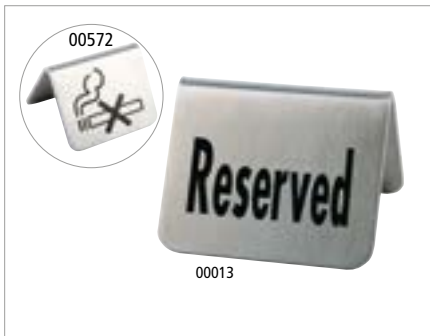

00013

Tischaufsteller 2er Set

table stands, 2 pcs.
caballetes de mesa, set de 2
chevalets de table, set de 2



	cm	↑ cm		pcs.	€ / set
00017	5,5 x 5	3,5	reserviert	2	4,20
00013	5,5 x 5	3,5	reserved	2	4,20
00572	5,5 x 5	3,5	no smoking	2	7,20



Beschriftungsetiketten

labeling labels
etiquetas
étiquettes



12 Bögen mit je 6 Motiven, selbstklebend, mit wasserlöslichem Stift beschreibbar

12 sheets includes 6 self-adhesive and removable labels, use regular chalkboard markers and wipe clean with a damp cloth

12 hojas, cada una con 6 motivos autoadhesivos, se pueden marcar con un rotulador lavable con agua

12 feuilles chacune avec 6 motifs autoadhésifs, on peut écrire avec un stylo lavable à l'eau

	cm	Farbe / Colour	€
00069	8,0 x 4,5	■	10,00



Kreide-Marker, Stärke 2 mm, 2er Set

chalk marker, 2 pcs.
rotulador de tiza, set de 2
marqueur a la craie liquide, set de 2



Zum Gestalten und Beschriften von Tafeln, Glas und fast allen geschlossenen Oberflächen, deckende Flüssigkreide auf Wasserbasis, feucht abwischbar

For decorating and writing on boards, glass and almost all non-porous surfaces, opaque water-based liquid chalk, wet-wipeable

Rotuladores para pizarra de tiza líquida para decorar y escribir sobre pizarras, cristales y casi todas las superficies no porosas. Tiza líquida opaca al agua que se pueda borrar con un trapo

Pour décorations et inscriptions sur tableaux, verre et presque toutes les surfaces non poreuses, craie liquide opaque à base d'eau, effaçable avec un chiffon humide

	Ø cm	↑ cm	Farbe / Colour	pcs.	€ / set
71490	1	13	■	2	6,20
71491	1	13	■	2	6,20

NEW

Der nachhaltige Mehrwegbecher – made in Germany



eco-friendly

400 ml



Das Ribbendesign isoliert die Hitze – kein „Verbrennen“ der Finger möglich

The rib design insulates the heat - no „burning“ of the fingers possible

Mehrwegbecher individuell mit Ihrem Logo/Namen herstellbar ab 500 Stck. – sprechen Sie uns an!

Reusable cups can be individually produced with your logo/name. From 500 pieces - please contact us!

- ✓ aufsteckbarer Deckel mit Trinköffnung
- ✓ 100% recyclebar
- ✓ spülmaschinengeeignet
- ✓ stapelbar mit und ohne Deckel
- ✓ schwappsicher

- clip-on lid with drinking opening
- 100% recyclable
- dishwasher safe
- stackable with and without lid
- slosh-/leak-proof

NEW



To Go Mehrwegbecher

To Go reusable cup
vaso reutilizable To Go
tasse réutilisable To Go

Becher (ohne Deckel)

cup (without cover)

vaso (sin tapa)

tasse (sans couvercle)



	Ø cm	↑ cm	ltr.	Farbe / Colour	VE / unit	€/ pc.
66910	8,5	13,5	0,4		48	2,00
66911	8,5	13,5	0,4		48	2,00
66912	8,5	13,5	0,4		48	2,00
66913	8,5	13,5	0,4		48	2,00

Deckel / cover / tapa / couvercle

	Ø cm	↑ cm	Farbe / Colour	VE / unit	€/ pc.
66914	8,5	2,5		48	1,00
66915	8,5	2,5		48	1,00
66916	8,5	2,5		48	1,00
66917	8,5	2,5		48	1,00





Körbe

baskets

cestas

corbeilles

PROFI LINE.....	308
GN LINE.....	312
ECONOMIC.....	314
BASKETS COVERS.....	318
BASIC.....	319
BREAD BASKETS.....	320
SNACKHOLDERS.....	323
URBAN.....	324
SVART.....	325
STAINLESS STEEL BASKETS.....	326
BASKETS RISERS.....	328
LUNCHBOXES.....	329
SUPERBOX.....	330

PROFI LINE



hellbeige / light beige
beis claro / beige clair

beige / beige
beis / beige

braun / brown
marrón / marron

schwarz / black
negro / noir

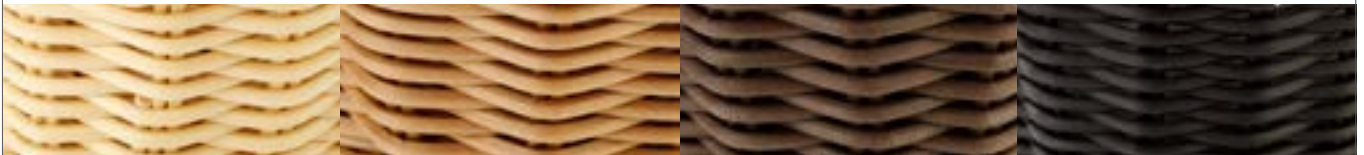

50915

50918

Korb "PROFI LINE"
basket baker size
cesta tamaño panaderia
corbeille dimensions „boul-pâte“



	cm	↑ cm	Farbe / Colour	€
50915	60 x 40	5		42,00
50918	60 x 40	5		42,00



50910

50913

Korb "PROFI LINE"
basket baker size
cesta tamaño panaderia
corbeille dimensions „boul-pâte“



	cm	↑ cm	Farbe / Colour	€
50910	60 x 20	5		28,40
50913	60 x 20	5		28,40



50908

50710

Korb "PROFI LINE"
basket baker size
cesta tamaño panaderia
corbeille dimensions „boul-pâte“



	cm	↑ cm	Farbe / Colour	€
50905	40 x 30	5		25,80
50908	40 x 30	5		25,80
	cm	↑ cm	Farbe / Colour	€
50710	40 x 30	10		27,40
50712	40 x 30	10		27,40



Systemkorb, gestäbt „PROFI LINE“

basket
cesta
corbeille



	cm	↑ cm	Farbe / Colour	€
50305	45 x 40	27 / 16		85,00



Systemkorb „PROFI LINE“

basket
cesta
corbeille



	cm	↑ cm	Farbe / Colour	€
50400	40 x 50	25 / 14		66,00



GN 1/1 Korb „PROFI LINE“

GN 1/1 basket
GN 1/1 cesta
GN 1/1 corbeille



	cm	↑ cm	Farbe / Colour	€
50722	53 x 32,5	10		35,40



Korb, rund „PROFI LINE“

basket, round
cesta redonda
corbeille ronde



	Ø cm	↑ cm	Farbe / Colour	€
50205	31 / 37	12 / 6		27,00



Korb, rund „PROFI LINE“

basket, round
cesta redonda
corbeille ronde



	Ø cm	↑ cm	Farbe / Colour	€
50210	37	9		21,90



Korb, rechteckig „PROFI LINE“

basket, rectangular
cesta, rectangular
corbeille, rectangulaire



	cm	↑ cm	Farbe / Colour	€
50702	26,5 x 19	7		12,50

	cm	↑ cm	Farbe / Colour	€
50707	31 x 21	9		14,20

PROFI LINE



Baguette Korb, oval „PROFI LINE“

baguette basket, oval
cesta de baguette, oval
corbeille à baguettes, ovale



	cm	↑ cm	Farbe / Colour	€
50805	28 x 16	8		11,20
50806	28 x 16	8		11,20
50808	28 x 16	8		11,20
50807	28 x 16	8		11,20
	cm	↑ cm	Farbe / Colour	€
50823	40 x 16	8		15,00



Korb, oval „PROFI LINE“

basket, oval
cesta oval
corbeille ovale



	cm	↑ cm	Farbe / Colour	€
50800	25 x 19	6,5		10,00
50801	25 x 19	6,5		10,00
50803	25 x 19	6,5		10,00
50802	25 x 19	6,5		10,00
	cm	↑ cm	Farbe / Colour	€
50815	32 x 23	7		12,80
50817	32 x 23	7		12,80



Korb, rund „PROFI LINE“

basket, round
cesta redonda
corbeille ronde



	Ø cm	↑ cm	Farbe / Colour	€
50600	16	8		8,40
50601	16	8		8,40
50603	16	8		8,40
50602	16	8		8,40
	Ø cm	↑ cm	Farbe / Colour	€
50605	20	8		11,20
50606	20	8		11,20
50608	20	8		11,20
50607	20	8		11,20
	Ø cm	↑ cm	Farbe / Colour	€
50612	29	7		14,20



Korb, rechteckig „PROFI LINE“

basket, rectangular
cesta rectangular
corbeille rectangulaire



	cm	↑ cm	Farbe / Colour	€
50631	19 x 13	6		5,90
50630	19 x 13	6		5,90



50624

Korb, oval „PROFI LINE“

basket, oval
cesta, oval
corbeille, ovale



	cm	↑ cm	Farbe / Colour	€
50624	19 x 12	6		5,90
50625	19 x 12	6		5,90
50627	19 x 12	6		5,90
50626	19 x 12	6		5,90



50620

50621

50622

50623

Korb, rund „PROFI LINE“

basket, round
cesta, redonda
corbeille, ronde



	Ø cm	↑ cm	Farbe / Colour	€
50620	13	10		5,90
50621	13	10		5,90
50623	13	10		5,90
50622	13	10		5,90



Auslage Tablett flach „PROFI LINE“

display tray flat, baker size
bandeja de presentación, tamaño panadería
plateau de présentation, dimensions „boul-pâte“



	cm	↑ cm	Farbe / Colour	€
40296	40 x 30	1		18,20
40297	60 x 40	1		32,00

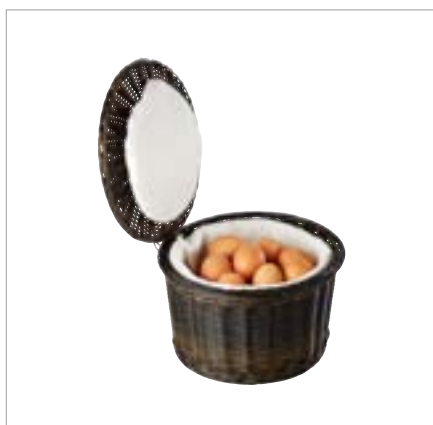

Eierkorb „PROFI LINE“

egg basket
cesta de huevos
panier à oeufs



mit Edelstahldraht im Rand, für ca. 20 Eier, hält den Inhalt durch das Stofffutter lange warm
with stainless steel wire in the rim, for around 20 eggs, keeps the eggs warm thanks to the fabric lining

con alambre de acero inoxidable en el borde, para unos 20 huevos, mantiene los huevos calientes gracias al forro de tela

avec un fil d'acier inox dans la jante, pour env. 20 oeufs, garde les oeufs au chaud grâce à la doublure en tissu

	Ø cm	↑ cm	Farbe / Colour	€
40299	26	17		24,00



Eierkorb

egg basket
cesta de huevos
panier à oeufs



stabile Vollweide, für ca. 20 Eier, hält den Inhalt durch das Stofffutter lange warm

stable willow, for around 20 eggs, keeps the eggs warm thanks to the fabric lining

sauce de estable, para unos 20 huevos, mantiene los huevos calientes gracias al forro de tela

saule stable, pour env. 20 oeufs, garde les oeufs au chaud grâce à la doublure en tissu

	Ø cm	↑ cm	Farbe / Colour	€
30299	26	17		21,00

GN LINE

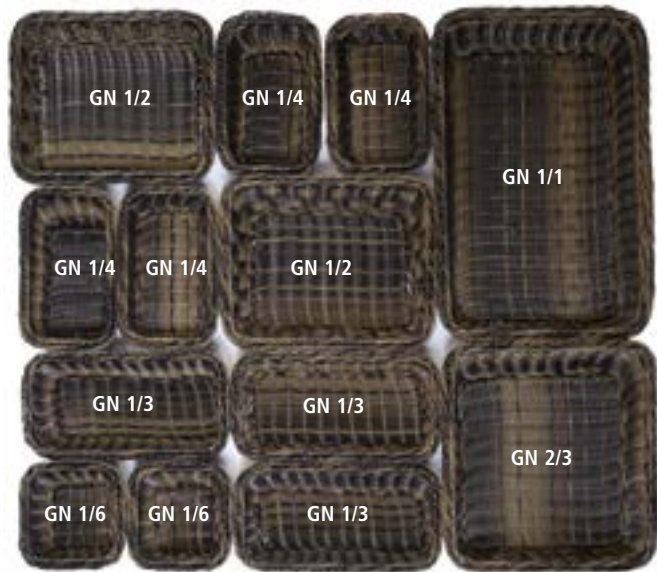

2 Höhen - 6,5 und 10 cm
2 heights - 6,5 and 10 cm



40293
GN 1/1 - 10 cm



40292
GN 1/2 - 10 cm

40225
GN 1/4 - 6,5 cm

Korb „GN LINE“

GN basket

GN cesta

GN corbeille



stabile Ausführung mit Edelstahldraht im Rand zur Stabilisierung

very solid with stainless steel wire frame to stabilize the basket

muy resistente con refuerzo de alambre inox

très résistante avec son fil de renfort inox

	cm	↑ cm	GN	Farbe / Colour	€
40291	53,0 x 32,5	6,5	1/1		26,00
40290	32,5 x 26,5	6,5	1/2		15,80
40223	32,5 x 17,6	6,5	1/3		12,60
40225	26,5 x 16,2	6,5	1/4		9,60
40227	17,6 x 16,2	6,5	1/6		6,50
40229	32,5 x 35,4	6,5	2/3		18,80

	cm	↑ cm	GN	Farbe / Colour	€
40293	53,0 x 32,5	10,0	1/1		31,40
40292	32,5 x 26,5	10,0	1/2		18,80
40243	32,5 x 17,6	10,0	1/3		14,80
40245	26,5 x 16,2	10,0	1/4		11,40
40247	17,6 x 16,2	10,0	1/6		9,60
40249	32,5 x 35,4	10,0	2/3		23,00



GN 1/1

GN 1/1 Besteckbehälter

GN 1/1 dispenser GN

GN 1/1 dispensador de cubiertos

GN 1/1 bac à couverts



4 Mulden, Kunststoff-Geflecht, Drahtgestell, braun-schwarz

4 compartments, with reinforced chromed wire structure, brown-black

4 compartimentos, de plástico, con bastidor cromado reforzado, marrón oscuro

4 compartiments, en plastique, cadre acier chromé renforcé, couleur marron foncé

	cm	↑ cm	GN	Farbe / Colour	€
11966	53 x 32,5	9	1/1		41,00

GN LINE

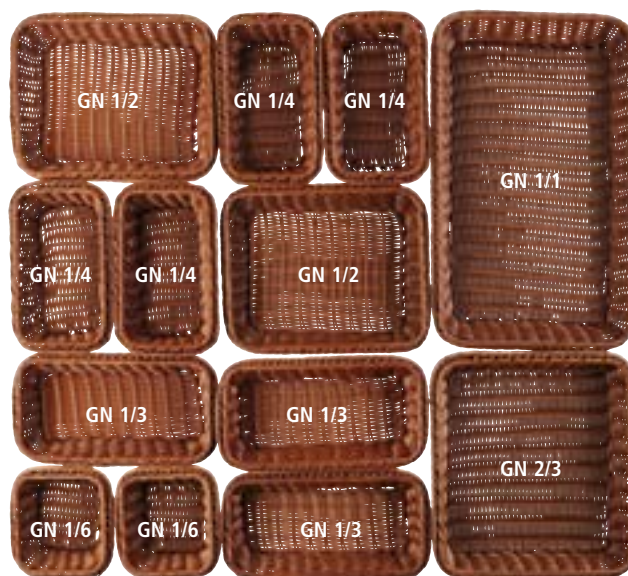

2 Höhen - 6,5 und 10 cm
2 heights - 6,5 and 10 cm



40220 GN 1/1



40222 GN 1/2



40228 GN 1/6



40264 GN 1/4

40272 GN 1/2

Korb „GN LINE“

GN basket
GN cesta
GN corbeille



stabile Ausführung mit Edelstahldraht im Rand zur Stabilisierung

very solid with stainless steel wire frame to stabilize the basket

muy resistente con refuerzo de alambre inox

très résistante avec son fil de renfort inox

	cm	↑ cm	GN	Farbe / Colour	€
40220	53,0 x 32,5	6,5	1/1		23,00
40222	32,5 x 26,5	6,5	1/2		13,90
40224	32,5 x 17,6	6,5	1/3		11,80
40226	26,5 x 16,2	6,5	1/4		8,80
40228	17,6 x 16,2	6,5	1/6		6,20
40230	32,5 x 35,4	6,5	2/3		18,20
	cm	↑ cm	GN	Farbe / Colour	€
40240	53,0 x 32,5	10	1/1		30,00
40242	32,5 x 26,5	10	1/2		18,40
40244	32,5 x 17,6	10	1/3		13,90
40246	26,5 x 16,2	10	1/4		10,00
	cm	↑ cm	GN	Farbe / Colour	€
40260	53,0 x 32,5	6,5	1/1		23,00
40262	32,5 x 26,5	6,5	1/2		13,90
40263	32,5 x 17,6	6,5	1/3		11,40
40264	26,5 x 16,2	6,5	1/4		8,80
	cm	↑ cm	GN	Farbe / Colour	€
40270	53,0 x 32,5	10	1/1		30,00
40272	32,5 x 26,5	10	1/2		18,40
40274	32,5 x 17,6	10	1/3		13,90
40276	26,5 x 16,2	10	1/4		9,90

ECONOMIC



Tisch- und Buffetkorb „ECONOMIC“
buffet basket
cesta de buffet
corbeille de buffet



	Ø cm	↑ cm	Farbe / Colour	€
40132	19,0	9,5		5,40
40135	25,5	8,5		7,40
40144	39,0	10,0		19,00
40191	19,0	9,5		5,40
40192	25,5	8,5		7,40

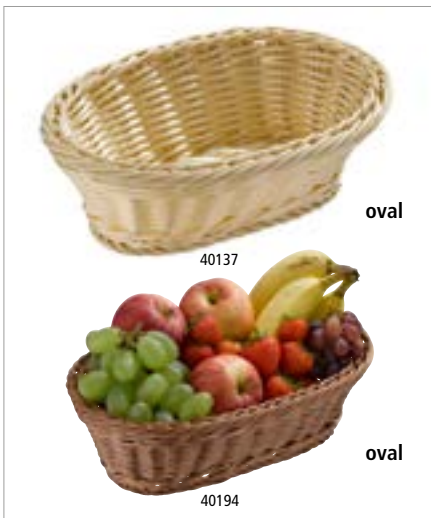

Tisch- und Buffetkorb „ECONOMIC“
buffet basket
cesta de buffet
corbeille de buffet



	cm	↑ cm	Farbe / Colour	€
40137	23,0 x 17	8,0		5,90
40139	28,5 x 17	8,5		7,60
40193	23,0 x 17	8,0		5,90
40194	28,5 x 17	8,5		7,60



stapelbar
stackable



Tisch- und Buffetkorb „ECONOMIC“
buffet basket
cesta de buffet
corbeille de buffet



	cm	↑ cm	Farbe / Colour	€
40140	23,0 x 17	8		5,90
40159	31,5 x 22	8,5		8,80
40195	23,0 x 17	8		5,90
40196	31,5 x 22	8,5		8,80



GN Buffetkorb „ECONOMIC“
GN basket
GN cesta
GN corbeille



	cm	↑ cm	GN	Farbe / Colour	€
40148	53 x 32,5	8	1/1		33,00



GN Buffetkorb „ECONOMIC“
GN basket
GN cesta
GN corbeille



	cm	↑ cm	GN	Farbe / Colour	€
40152	32,5 x 26,5	8	1/2		13,20

**Buffetkorb „ECONOMIC“**

buffet basket
cesta de buffet
corbeille de buffet



stabile Ausführung mit Edelstahldraht im Rand zur Stabilisierung

very solid with stainless steel wire frame to stabilize the basket

muy resistente con refuerzo de alambre inox

très résistante avec son fil de renfort inox

	cm	↑ cm	€
40153	45 x 42	17 / 24	34,90



40149

Buffetkorb, rund „ECONOMIC“

buffet basket, round
cesta de buffet, redonda
corbeille de buffet ronde



stabile Ausführung mit Edelstahldraht im Rand zur Stabilisierung

very solid with stainless steel wire frame to stabilize the basket

muy resistente con refuerzo de alambre inox

très résistante avec son fil de renfort inox

	Ø cm	↑ cm	Farbe / Colour	€
40149	40	12,5		25,20
40295	40	12,5		23,00



18389

Rolltophaube mit verchromtem Kugelgriff / rolltop cover with chrome plated handle / campana abatible con pomo cromado / cloche basculante avec bouton chromé

	Ø cm	↑ cm	€
18388	38	20	24,00

Rolltophaube mit vergoldetem Kugelgriff / rolltop cover with gold plated handle / campana abatible con pomo dorado / cloche basculante avec bouton doré

	Ø cm	↑ cm	€
18387	38	20	24,00

Rolltophaube mit verchromtem Designergriff / rolltop cover with chrome plated designer handle / campana abatible con pomo de diseño cromado / cloche basculante avec bouton design chromé

	Ø cm	↑ cm	€
18389	38	20	23,00



11010

Buffetkorb „ECONOMIC“

buffet basket
cesta de buffet
corbeille buffet



stabile Ausführung, Edelstahl Fixierungsrahmen, zur Rutschsicherung, ohne Haube

stainless steel fix the cover, without cover

con marco cromado patentado para fijar y encajar la campana (se entrega sin la campana)

cadre fil acier inoxydable pour fixer la cloche (livré sans la cloche)

	cm	↑ cm	Farbe / Colour	€
40150	56,5 x 36	10		40,00
40294	56,5 x 36	10		33,00



11018

GN 1/1 Rolltop-Haube / GN 1/1 rolltop cover / GN 1/1 campana abatible / GN 1/1 cloche basculante

	cm	↑ cm	GN	€	
11008	53 x 32,5	19	1/1	vergoldeter Griff / gold plated handle pomo dorado / bouton doré	62,00
11010	53 x 32,5	19	1/1	verchromter Griff / chrome plated handle pomo cromado / bouton chromé	62,00
11018	53 x 32,5	17	1/1	mit verchromtem Designergriff with chrome plated designer handle	64,00

ECONOMIC



Buffetgestell „DOPPELDECKER“ für GN

buffet frame for GN
estructura para buffet para GN
support buffet pour GN



2-teilig, einfach zusammensetzbar, Etagen-Abstand 26 cm, platzsparend, stabile Ausführung

2 pcs., easy to assemble, distance between the tiers 26 cm, space-saving, robust

2 pzas, fácil de montar, distancia entre pisos 26 cm, robusto

2 pcs, assemblage facile, distance entre niveaux 26 cm, robuste

	cm	↑ cm	fits to GN	€
11555	50 x 34	37,5	1/1	90,00



GN Kuppelhaube

GN cover
GN cúpula
GN cloche bombée



glasklarer Kunststoff, Griff aus Zinkdruckguss

crystal clear plastic, die-cast zinc knob

plástico transparente, asa de zinc fundido a presión

plastique transparente, poignée en zinc moulé sous pression

	cm	↑ cm	GN		€
11026	54 x 33	20	1/1	geschlossen / totally closed cerrada / totalmente fermée	52,00
11027	54 x 33	20	1/1	mit Front-Ausschnitt / one long side cut out gran apertura frontal / grande ouverture frontale	54,00
11028	54 x 33	20	1/1	mit seitlichem Ausschnitt / one small side cut out / pequeña apertura lateral / petite ouverture latérale	54,00



GN Kuppelhaube

GN cover
GN cúpula
GN cloche bombée



glasklarer Kunststoff, Griff aus Zinkdruckguss

crystal clear plastic, die-cast zinc knob

plástico transparente, asa de zinc fundido a presión

plastique transparente, poignée en zinc moulé sous pression

	cm	↑ cm	GN		€
11070	54 x 33	20	1/1	geschlossen / totally closed cerrada / totalmente fermée	52,00
11071	54 x 33	20	1/1	mit Front-Ausschnitt / one long side cut out gran apertura frontal / grande ouverture frontale	54,00
11072	54 x 33	20	1/1	mit seitlichem Ausschnitt / one small side cut out / pequeña apertura lateral / petite ouverture latérale	54,00



Baguettekorb „ECONOMIC“

baguette basket
cesta para baguette
corbeille pour baguettes



stabile Ausführung mit Edelstahl draht im Rand zur Stabilisierung

very solid with stainless steel wire frame to stabilize the basket

muy resistente con refuerzo de alambre inox

très résistante avec son fil de renfort inox

	Ø cm	↑ cm	Farbe / Colour	€
40198	35	24 / 42		57,00



Besteckkorb „ECONOMIC“

cutlery dispenser
dispensador de cubiertos
corbeille à couverts



4 Fächer (3 kleine und 1 großes) / 4 compartments (3 small and 1 large) /
4 compartimentos (3 pequeños y 1 grande) / 4 compartiments (3 petits et 1 grand)

	cm	↑ cm	Farbe / Colour	€
40179	26 x 18	15		17,60
40182	26 x 18	15		17,60



Besteckkorb „ECONOMIC“

cutlery dispenser
dispensador de cubiertos
corbeille à couverts



	Ø cm	↑ cm	Farbe / Colour	€
40130	12	15		4,80
40007	12	15		4,80
40012	12	15		4,80
40013	12	15		4,80



Besteckkorb „ECONOMIC“

cutlery dispenser
dispensador de cubiertos
corbeille à couverts



	cm	↑ cm	Farbe / Colour	€
40131	27 x 10	4,5		4,80
40009	27 x 10	4,5		4,80
40010	27 x 10	4,5		4,80
40011	27 x 10	4,5		4,80



Brot- und Obstkorb „WICKER LOOK“

basket for bread or fruits
cesta para pan o fruta
corbeille à pain ou à fruits



	cm	↑ cm	Farbe / Colour	€
40214	Ø 20	6,5	■	3,20
40216	23 x 17	6,5	■	3,50

	cm	↑ cm	Farbe / Colour	€
40211	39,5 x 29,5	10	■	10,00
40212	39,5 x 29,5	10	■	10,00
40210	39,5 x 29,5	10	■	10,00



GN 1/1 Korb „SUPERSTRONG“

GN 1/1 basket
GN 1/1 cesta
GN 1/1 corbeille



	cm	↑ cm	GN	Farbe / Colour	€
50644	53 x 32,5	10,0	1/1	■	34,20

GN Kuppelhaube / GN cover / GN cúpula / GN cloche bombée

	cm	↑ cm	GN	€
11027	54 x 33	20	1/1	54,00



passend zu Regalwagen 71441, S. 365
suitable for trolley 71441, S. 365



GN Kuppelhaube

GN cover
GN cúpula
GN cloche bombée



glasklarer Kunststoff, Griff aus Zinkdruckguss

crystal clear plastic, die-cast zinc knob

plástico transparente, asa de zinc fundido a presión

plastique transparente, poignée en zinc moulé sous pression

	cm	↑ cm	GN	€
11070	54 x 33	20	1/1 geschlossen / totally closed cerrada / totalmente fermée	52,00
11071	54 x 33	20	1/1 mit Front-Ausschnitt / one long side cut out gran apertura frontal / grande ouverture frontale	54,00
11072	54 x 33	20	1/1 mit seitlichem Ausschnitt / one small side cut out / pequeña apertura lateral / petite ouverture latérale	54,00



GN Abdeckhaube

GN cover
GN cubierta
GN cloche



passend für GN 1/1 Körbe, glasklarer Kunststoff, nahezu bruchfest

suitable for GN 1/1 baskets, clear plastic, nearly unbreakable

apto para cestas GN 1/1, plástico transparente, muy resistente a la rotura

pour bacs et corbeilles GN 1/1, plastique transparent, très résistant à la casse

	cm	↑ cm	mm	GN	€
11042	53,0 x 32,5	9,5	3	1/1	32,00

stapelbar
stackable

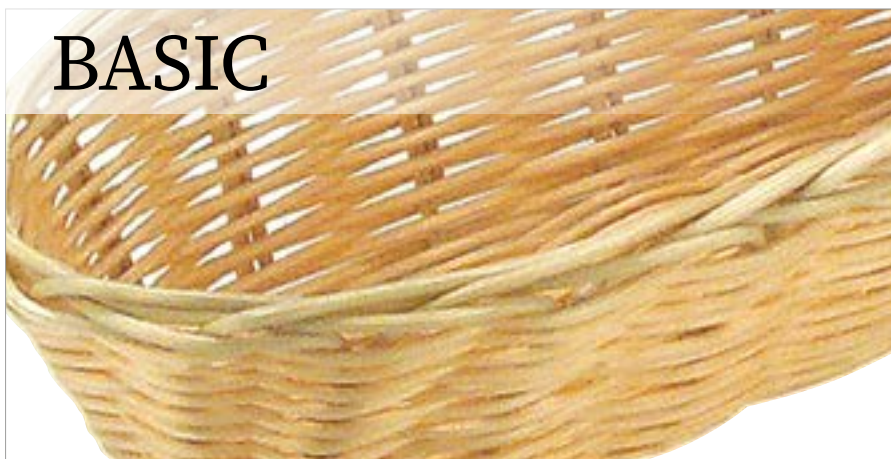

BASIC

- in Handarbeit geflochten
- einfache und leichte Ausführung

- wickerwork
- simple and light version

- ligera
- tressada a mano

- tressé à main
- version légère



oval

Brot- und Obstkorb „BASIC“

basket for bread or fruits
cesta para pan o fruta
corbeille à pain ou à fruits



	cm	↑ cm	€
30279	18 x 12	7	3,20
30280	23 x 15	6	3,40



oval

Brot- und Obstkorb „BASIC“

basket for bread or fruits
cesta para pan o fruta
corbeille à pain ou à fruits



	cm	↑ cm	€
30282	21 x 10	6	3,00



rund

Brot- und Obstkorb „BASIC“

basket for bread or fruits
cesta para pan o fruta
corbeille à pain ou à fruits



	Ø cm	↑ cm	€
30281	20	7	3,40
30285	25	7	4,70



rechteckig

Tisch- und Buffetkorb „BASIC“

buffet basket
cesta de buffet
corbeille de buffet



	cm	↑ cm	€
30286	30 x 22	7	4,60
30283	22 x 15	6	3,70

BREAD BASKETS



Umgekrempelt kann die Höhe individuell gestaltet werden!

Adjustable height by turning the edge upside down!

Altura ajustable girando el borde al revés!

Hauteur ajustable en tournant le bord à l'envers!



Brottasche bread basket panera corbeille



eckig, 70% Naturfaser und 30% Kunstharz

angular, 70% natural fibre and 30% synthetic resin

ángulo, 70% fibra natural y 30% resina sintética

carré, 70% de fibres naturelles et 30% de résine synthétique

	cm	↑ cm	Farbe / Colour	€
30355	12 x 11,5	11,5		6,80
30356	12 x 11,5	11,5		6,80

rund, 70% Naturfaser und 30% Kunstharz

round, 70% natural fibre and 30% synthetic resin

redondo, 70% fibra natural y 30% resina sintética

ronde, 70% de fibres naturelles et 30% de résine synthétique

	Ø cm	↑ cm	Farbe / Colour	€
30440	17	11		7,20
30450	20	13		8,20
30442	24	24		12,50
30443	30	22		14,80
30441	17	11		7,20
30451	20	13		8,20
30445	24	24		12,50
30446	30	22		14,80

oval, 70% Naturfaser und 30% Kunstharz

oval, 70% natural fibre and 30% synthetic resin

oval, 70% fibra natural y 30% resina sintética

ovale, 70% de fibres naturelles et 30% de résine synthétique

	cm	↑ cm	Farbe / Colour	€
30444	30 x 20	18		11,50
30447	30 x 20	18		11,50



Brottasche
bread basket
panera
corbeille



rund, schmutzabweisende Kunstfaser, 30°C waschbar, wendbar
round, dirt-repellent synthetic fibre, washable 30°C, reversible
redondo, fibra sintética repelente a la suciedad, lavable a 30°C, reversible
ronde, fibre synthétique anti-salissante, lavable à 30°C, réversible

	Ø cm	↑ cm	Farbe / Colour	€
30345	17	11,5	■ ■	8,40
30346	20	13,5	■ ■	10,40



Brottasche
bread basket
panera
corbeille



rechteckig, schmutzabweisende Kunstfaser, 30°C waschbar, wendbar
rectangular, dirt-repellent synthetic fibre, washable 30°C, reversible
rectangular, fibra sintética repelente a la suciedad, lavable a 30°C, reversible
rectangulaire, fibre synthétique anti-salissante, lavable à 30°C, réversible

	cm	↑ cm	Farbe / Colour	€
30347	19 x 11	10,5	■ ■	9,30
30348	24 x 16	10,5	■ ■	11,50



Präsentationsmöglichkeit
presentation example



Brottasche
bread basket
panera
corbeille à pain en toile



Baumwolle, umgekrempelt kann die Höhe individuell gestaltet werden, maschinenwaschbar bis 30°C
cotton, adjustable height by turning the edge upside down, machine-washable 30°C
walgodón, altura ajustable girando el borde al revés, lavable a máquina 30°C
coton, hauteur ajustable en tournant le bord à l'envers, lavable en machine maxi 30°C

	Ø cm	↑ cm	Farbe / Colour	€
30340	17	11	■ ■	7,00
30350	20	12	■ ■	7,70
30341	17	11	■ ■	7,00
30351	20	12	■ ■	7,70

	cm	↑ cm	Farbe / Colour	€
30360	20 x 15	10	■ ■	7,30
30370	25 x 18	12	■ ■	8,30
30361	20 x 15	10	■ ■	7,30
30371	25 x 18	12	■ ■	8,30

BREAD BASKETS



Brottasche mit Wärmekissen

bread basket with stones pillow
panera con cojín
corbeille à pain en toile avec coussin chauffant



Baumwolle, Keramik-Kugeln, maschinenwaschbar bis 30°C, mit Zugverschluss, Wärmekissen kann einfach in der Mikrowelle erhitzt werden (90 Sekunden / 500 Watt)

cotton, ceramic balls, machine washable up to 30°C, with drawstring closure, heat pad can easily be heated in the microwave (90 seconds / 500 watts)
algodón, bolas de cerámica, lavable a máquina hasta 30°C, con cierre de cordón, la almohadilla térmica se puede calentar fácilmente en el microondas (90 segundos / 500 vatios)
coton, billes en céramique, lavable en machine jusqu'à 30°C, avec fermeture à tirette, le coussin chauffant peut être facilement chauffé au micro-ondes (90 secondes / 500 watts)

	Ø cm	↑ cm	Farbe / Colour	€
30380	19	23		21,00
30390	19	23		21,00

Wärmekissen / stones pillow / cojín de piedrecillas a calentar / coussin de petites pierres, à chauffer

	Ø cm	↑ cm	€
30385	19	1,5	5,90



Häkelkorb

crochet rope basket
cesta de cuerda de ganchillo
panier en corde au crochet



umgekrepelt kann die Höhe individuell eingestellt werden

adjustable height by turning the edge upside down
altura ajustable girando el borde al revés
hauteur ajustable en tournant le bord à l'envers

	cm	↑ cm	€
30395	20 x 13,5	10	9,00
30396	24 x 17,5	12	10,00



Präsentationsmöglichkeit
presentation example



Lunchbag, 2er Set

lunch bag, 2 pcs.
bolsa de almuerzo, set de 2
sac à lunch, set de 2



70% Naturfaser und 30% Kunstharz, mit Klettverschluss

70% natural fibre and 30% synthetic resin, with velcro fastener
70% fibra natural y 30% resina sintética, con cierre de velcro
70% de fibres naturelles et 30% de résine synthétique, avec fermeture velcro

	cm	↑ cm	pcs.	€ / set
30357	16 x 10	32	2	17,00
30358	25 x 15	30	2	22,00



Präsentationsmöglichkeit
presentation example



40690 0,7 ltr.



40691 0,7 ltr.



40692 0,7 ltr.



40693 1,4 ltr.



40694 1,4 ltr.



40695 1,4 ltr.

Schale
bowl
cuenco
bol

gehämmerte Oberfläche
hammered surface
superficie martillada
surface martelée



	Ø cm	↑ cm	ltr.	Farbe / Colour	€
40690	15,5 x 12,0	5,5	0,7	gold look	13,60
40691	15,5 x 12,0	5,5	0,7	copper look	13,60
40692	15,5 x 12,0	5,5	0,7	gunmetal-look	13,60
40693	23,0 x 15,5	6,0	1,4	gold look	20,40
40694	23,0 x 15,5	6,0	1,4	copper look	20,40
40695	23,0 x 15,5	6,0	1,4	gunmetal-look	20,40



Präsentationsmöglichkeit
presentation example



40604

Servierkorb „BURGER & FRIES“

serving basket
cesta para servir
corbeille de service

Servierkorb aus Metall mit 2 Haltern für Dipschälchen

metal serving basket with 2 holders for dip bowls
cesta de metal para servir con 2 soportes para cuencos para dip
corbeille de service en métal avec 2 supports pour ramequins



	cm	↑ cm	€
40604	39,5 x 20	11	10,00

passende Schälchen / suitable bowls / cuencos adecuados / bols
appropriés



	Ø cm	↑ cm	ltr.	VE / unit	€ / pc.
83781	7,5	4	0,07	24	1,50



Servierbeispiel - Lieferung ohne Schälchen
delivery without bowls



Präsentationsmöglichkeit
presentation example

URBAN



GN Korb „URBAN“ GN basket GN cesta GN corbeille



	cm	↑ cm	GN	Farbe / Colour	€
30414	53,0 x 32,5	7,5	1/1	■	35,00
30415	32,5 x 26,5	7,5	1/2	■	26,00
30416	53,0 x 16,2	7,5	2/4	■	26,00

GN Abdeckhaube GN cover GN cubierta GN cloche



	cm	↑ cm	GN		€
11044	53 x 16,2	10,5	2/4	ohne Abbildung	23,00
11042	53 x 32,5	9,5	1/1	ohne Abbildung	32,00
11022	33 x 28,0	17,0	1/2	ohne Abbildung	32,00
11027	54 x 33,0	20,0	1/1		54,00



Korb „URBAN“ basket cesta corbeille



	cm	↑ cm	Farbe / Colour	€
30337	29 x 16	7	■	19,00



Korb „URBAN“ basket cesta corbeille



	Ø cm	↑ cm	Farbe / Colour	€
30410	17	7,0	■	14,40
30411	20	8,5	■	18,00



Korb „URBAN“ basket cesta corbeille



	cm	↑ cm	Farbe / Colour	€
30412	21 x 10	7	■	12,80
30413	30 x 14	12	■	21,00

SVART



NEW



Korb „SVART“
basket
cesta
corbeille

Black
&
beautiful

METALL



	cm	↑ cm	Farbe / Colour	€
30424	29,5 x 25,5	13,5	■	24,00



Präsentationsmöglichkeit
presentation example



30422



30423

Korb „SVART“
basket
cesta
corbeille

Black
&
beautiful

METALL



	cm	↑ cm	Farbe / Colour	€
30422	20 x 15	8	■	13,00
30423	24 x 19	8	■	17,80



30420



30421

Korb „SVART“
basket
cesta
corbeille

Black
&
beautiful

METALL



	Ø cm	↑ cm	Farbe / Colour	€
30420	17,5	8	■	13,00
30421	20,0	8	■	15,00

STAINLESS STEEL BASKETS



Obstkorb
basket for fruits
cesta para fruta
corbeille à fruits

hochglanzpoliert
mirror polished finish
acabado pulido brillante
brillant



	Ø cm	↑ cm	€
30270	21,5	20,5	37,40



Brot- und Obstkorb
basket for bread or fruits
cesta para pan o fruta
corbeille à pain ou à fruits

hochglanzpoliert, rund
mirror polished finish, round
acabado pulido brillante, redondo
brillant, rond



	Ø cm	↑ cm	€
30200	17,5	7,0	12,60
30220	20,5	8,5	15,40
30230	25,5	9,5	17,20

oval / oval / oval / oval

	cm	↑ cm	€
30210	20 x 15	7,0	12,60
30240	24 x 19	8,5	15,40
30250	28 x 21	9,5	17,20



Brot- und Obstkorb
basket for bread or fruits
cesta para pan o fruta
corbeille à pain ou fruits



	Ø cm	↑ cm	€
30310	18	7,5	6,20



Brot- und Obstkorb „WIRE“
 wire basket
 cesta para pan o fruta
 corbeille pour pain ou fruits



	Ø cm	↑ cm	Farbe / Colour	€
30206	31	14	metal black	18,00



Präsentationsmöglichkeit
 presentation example

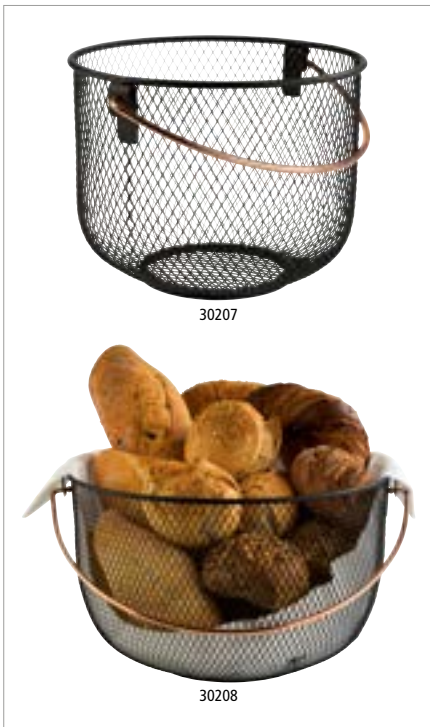

30207



30208

Brot- und Obstkorb
 basket for bread or fruits
 cesta para pan o fruta
 corbeille à pain ou fruits



	Ø cm	↑ cm	Farbe / Colour	€
30207	21	16,5	copper-look handle	13,20
30208	30	19,0	copper-look handle	16,40



Präsentationsmöglichkeit
 presentation example



40190 0,45 ltr.

Schale
 bowl
 cuenco
 bol



gehämmerte Oberfläche / hammered surface / superficie martillada / surface martelée

	cm	↑ cm	ltr.	€
40189	20 x 13,5	5,5	0,30	8,50
40190	24 x 16,5	7,0	0,45	10,60



30276

Brot- und Obstschale
 bowl for bread or fruits
 bol para pan o fruta
 bol à pain ou à fruits



hochglanzpoliert, Hammerschlag Optik
 mirror polished finish, hammered look
 acabado pulido efecto espejo, aspecto repujado
 brillant, aspect martelé

	Ø cm	↑ cm	€
30276	16	5,0	3,60
30277	20	5,5	6,00



BASKETS / RISERS



Korb / Ständer „APS PLUS“

basket / riser
cesta / soporte
corbeille / support



	Ø cm	↑ cm	Farbe / Colour	€
15320	10,5 / 8	8	polished chrome	16,40
15324	10,5 / 8	8	brushed gold	16,40
15322	10,5 / 8	8	brushed copper	15,00



Korb / Ständer „APS PLUS“

basket / riser
cesta / soporte
corbeille / support



	Ø cm	↑ cm	Farbe / Colour	€
15331	15	10,5	polished chrome	26,80
15332	21	20,0	polished chrome	43,70
15334	15	10,5	brushed gold	26,80
15335	21	20,0	brushed gold	43,70



Korb / Ständer „APS PLUS“

basket / riser
cesta / soporte
corbeille / support



	Ø cm	↑ cm	Farbe / Colour	€
15326	21 / 15	21	black	26,80

LUNCHBOXES

**Lunchbox „M“**lunchbox
fiambrella
boîte à lunch**Edelstahlbox mit Silikondichtung inkl. Trennsteg, auslaufsicher**

stainless steel box with silicone seal incl. divider, leak-proof

caja de acero inoxidable con junta de silicona y divisor extraíble, transporte sin salpicaduras

boîte en acier inox avec joint en silicone et diviseur amovible, transport sans éclaboussures

	cm	↑ cm	ltr.	€
66900	18,5 x 13,5	6,5	0,8	14,50

**Lunchbox „L“**lunchbox
fiambrella
boîte à lunch**Edelstahlbox mit Silikondichtung inkl. Trennsteg, auslaufsicher**

stainless steel box with silicone seal incl. divider, leak-proof

caja de acero inoxidable con junta de silicona y divisor extraíble, transporte sin salpicaduras

boîte en acier inox avec joint en silicone et diviseur amovible, transport sans éclaboussures

	cm	↑ cm	ltr.	€
66901	20,5 x 14,5	6,5	1,1	17,00

**Lunchbox „XL“**lunchbox
fiambrella
boîte à lunch**Edelstahlbox mit Silikondichtung inkl. Trennsteg, auslaufsicher**

stainless steel box with silicone seal incl. divider, leak-proof

caja de acero inoxidable con junta de silicona y divisor extraíble, transporte sin salpicaduras

boîte en acier inox avec joint en silicone et diviseur amovible, transport sans éclaboussures

	cm	↑ cm	ltr.	€
66902	22,5 x 16,5	6,5	1,4	19,50

mit zwei Verschlüssen
with 2 clasps

66900

0,8 ltr.



66901

1,1 ltr.



66902

1,4 ltr.

herausnehmbarer Trennsteg
removable divider

auslaufsicher | leak-proof





Die stapelbaren Wendeböden lassen sich rutschfest stapeln und mit flachen GN Platten verbinden und einzeln nutzen. Individuell können Buffet-landschaften gebaut werden.

The stackable and non-slip reversible boxes can be connected to flat GN trays and can also be used individually. Different and individual buffet sceneries can be built up.

Las cajas girables y apilables son antideslizantes y se pueden conectar con bandejas planas GN o utilizar individualmente. Se pueden construir diferentes paisajes de buffet muy individuales.

Les boîtes de tournage empilables sont antiglissantes et peuvent être connectées avec des plateaux plats GN ou utilisées individuellement. Des paysages de buffet très personnalisés peuvent être construits.



GN 1/1 „SUPERBOX“



Akazienholz / acacia wood / madera de acacia / bois d'acacia

	cm	↑ cm	GN	Farbe / Colour	€
11620	55,5 x 35,0	10,5	1/1		46,00
11626	55,5 x 35,0	10,5	1/1		46,00
11721	55,5 x 35,0	20,0	1/1		69,00
11723	55,5 x 35,0	20,0	1/1		69,00



GN 2/4 „SUPERBOX“



Akazienholz / acacia wood / madera de acacia / bois d'acacia

	cm	↑ cm	GN	Farbe / Colour	€
11623	55,5 x 18,5	10,5			36,00
11629	55,5 x 18,5	10,5			36,00



GN 1/2 „SUPERBOX“



Akazienholz / acacia wood / madera de acacia / bois d'acacia

	cm	↑ cm	GN	Farbe / Colour	€
11621	35,0 x 29,0	10,5	1/2		29,00
11627	35,0 x 29,0	10,5	1/2		29,00
11722	35,0 x 29,0	20,0	1/2		44,00
11724	35,0 x 29,0	20,0	1/2		44,00



GN 1/4 „SUPERBOX“

Akazienholz / acacia wood / mader de acacia / bois d'acacia



	cm	↑ cm	Farbe / Colour	€
11622	29 x 18,5	10,5		23,00
11628	29 x 18,5	10,5		23,00



GN „SUPERBOX VINTAGE“

Akazienholz
acacia wood
mader de acacia
bois d'acacia

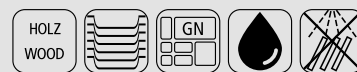

	cm	↑ cm	GN	Farbe / Colour	€
11715	55,5 x 35,0	10,5	1/1		46,00
11716	35,0 x 29,0	10,5	1/2		29,00
11717	29,0 x 18,5	10,5	1/4		23,00
11718	55,0 x 18,5	10,5	2/4		36,00



Präsentationsmöglichkeiten
presentation examples



Buffetgestell

buffet stand
soporte para buffet
présentoir buffet



Metall, schwarz, passend für GN Boxen, mit Antrutschfüßchen
metal, black, suitable for GN boxes, with non-slip feet
metal, negro, apto para cajas GN, con pies antideslizantes
métal, noir, pour boîtes GN, avec pieds antidérapants

	cm	↑ cm	suitable for	€
30331	49 x 38,5	48	GN 1/1, GN1/2 boxes	48,00



Präsentationsmöglichkeit
presentation example





Chafing Dish, GN Container & Transport

PREMIUM	334
GLOBE	336
EASY INDUCTION	339
INDUCTION STATION	341
CHAFING DISHES	342
FONDUE AND FIRE PUNCH BOWL SET	347
CHAFING DISHES ACCESSORIES	348
INDUCTION PLATES HEATING UNITS	349
HEATING UNITS WARMERS	350
GRANITE CHIPS CUTLERY RESTS	351
GN-CONTAINERS	352
SERVING TROLLEYS	364
CUTLERY BOXES	366
CONTAINERS EGG BOXES	368
BUCKETS FUNNELS	369

PREMIUM



langlebige Deckelbremse
Abnehmbarer Deckel, dieser lässt sich spielend leicht öffnen und schließen, der Lauf des Deckels wird professionell gedämpft.



Kondenswasser - Rücklaufsystem
Kondenswasser wird in das Wasserbecken zurückgeführt.



Sandwichboden / Kapselboden
Induktionsfähiger Boden, direkt auf dem Induktionskochfeld einsetzbar. Perfekte Wärmeverteilung und Steuerung.



Fixierschraube / Rutschsicherung
Höhenverstellbares Gelenk, fixiert das Gerät in dem Gestell und auf dem Tisch.



Induktionskochplatte Nr. 12295
Induktionskochplatte wird einfach in das Gestell gelegt.



stapelbar
Chafing Dish Rahmen sind übereinander stapelbar. Platzsparend und rutschfest stapeln und transportieren.



Induktionskochplatte für Chafing Dish

induction plate for chafing dish
placa de inducción para chafing dish
plaque à induction pour chafing dish

mit Regler
with power control
con control de potencia
avec régulateur

	Ø cm		€
12295	24	900 W	139,00



12370

Lieferung ohne Induktionskochplatte
delivery without induction plate
se entrega sin placa de inducción
livré sans plaque à induction

GN 1/1 Chafing Dish „PREMIUM“



1 Gestell + 1 Wasserbecken mit Sandwichboden + 1 Wasserbeckenrahmen + 1 Deckel mit hydraulischem Gelenk + 1 GN 1/1 Behälter 65 mm tief, hitzebeständige Griffe, hochwertige Verarbeitung, ausschließlich für Induktionskochfelder

1 frame + 1 waterpan with sandwich base + 1 frame for waterpan + 1 hydraulic cover + 1 GN 1/1 container 65 mm, heat resistant handles, high quality, only for induction plates

1 soporte + 1 cubeta baño maría con base sandwich + 1 marco para cubeta baño maría + 1 tapa hidráulica + 1 cubeta GN 1/1 de 65 mm, asas resistentes al calor, acabado de alta calidad, solamente para inducción

1 pied support + 1 bac bain-marie avec fond sandwich + 1 cadre pour bac bain-marie + 1 couvercle hydraulique + 1 bac GN 1/1 de 65 mm, poignées résistantes à la chaleur, finition de qualité, uniquement pour induction

	cm	↑ cm	ltr.		€
12370	66 x 48	33	9	mit Edelstahldeckel with stainless steel cover	894,00
12352	66 x 48	33	9	mit Glasdeckel with glass cover	1140,00



12353

Lieferung ohne Induktionskochplatte
delivery without induction plate
se entrega sin placa de inducción
livré sans plaque à induction

Chafing Dish rund „PREMIUM“



1 Gestell + 1 Wasserbecken mit Sandwichboden + 1 Wasserbeckenrahmen + 1 Deckel mit hydraulischem Gelenk + 1 runder Speisenbehälter, hitzebeständiger Griff, hochwertige Verarbeitung, für Induktionskochfelder geeignet

1 frame + 1 waterpan with sandwich base + 1 frame for waterpan + 1 hydraulic cover + 1 round foodpan, heat resistant handle, high quality, suitable for induction plates

1 soporte + 1 cubeta baño maría con base sandwich + 1 marco para cubeta baño maría + 1 tapa hidráulica + 1 cubeta redonda, asa resistente al calor, acabado de alta calidad, apto para inducción

1 pied support + 1 bac bain-marie avec fond sandwich + 1 cadre pour bac bain-marie + 1 couvercle hydraulique + 1 bac rond, poignée résistante à la chaleur, finition de qualité, apte pour induction

	cm	↑ cm	ltr.		€
12371	44 x 54	33	6	mit Edelstahldeckel with stainless cover	780,00
12353	44 x 54	33	6	mit Glasdeckel with glass cover	890,00

Speiseneinsatz / foodpan / cubeta / bac supérieur

		€
12366		24,00



12372

Lieferung ohne Induktionskochplatte
delivery without induction plate
se entrega sin placa de inducción
livré sans plaque à induction

Chafing Dish rund „PREMIUM“



1 Gestell + 1 Wasserbecken mit Sandwichboden + 1 Wasserbeckenrahmen + 1 Deckel mit hydraulischem Gelenk + 1 runder Speisenbehälter, hitzebeständige Griffe, hochwertige Verarbeitung, für Induktionskochfelder geeignet

1 frame + 1 waterpan with sandwich base + 1 frame for waterpan + 1 hydraulic cover + 1 round foodpan, heat resistant handles, high quality, suitable for induction plates

1 soporte + 1 cubeta baño maría con base sandwich + 1 marco para cubeta baño maría + 1 tapa hidráulica + 1 cubeta redonda, asas resistentes al calor, acabado de alta calidad, apto para inducción

1 pied support + 1 bac bain-marie avec fond sandwich + 1 cadre pour bac bain-marie + 1 couvercle hydraulique + 1 bac rond, poignées résistantes à la chaleur, finition de qualité, apte pour induction

	cm	↑ cm	ltr.		€
12372	44 x 48	39	10	mit Edelstahldeckel with stainless cover	780,00
12354	44 x 48	39	10	mit Glasdeckel with glass cover	890,00

Speisenbehälter / foodpan / cubeta superior / bac supérieur

		€
12397		22,00

GLOBE



die Deckelbremse sorgt für langsames Schließen

the revolving cover closes gently, thanks to a special built-in axle

sistema de freno para un cierre suave de la tapa

système avec frein pour une fermeture en douceur du couvercle



abnehmbarer Glas-Deckel mit Wasserrücklaufsystem

removable glass lid, with water-runback-system

tapa transparente desmontable con sistema de retorno de la condensación

couvercle transparent amovible avec système de retour de la condensation



Kondenswasser wird in das Wasserbecken zurückgeführt

condensed water is led back into the waterpan

el agua de condensación vuelve a la cubeta de agua

l'eau de condensation retourne dans le bac d'eau



für alle Herdarten geeignet, auch für Induktionskochplatten

suitable for all kinds of ovens, even induction cookers

apto para todas las fuentes de calor, incluso inducción

apte pour toutes les sources de chaleur, y compris induction



GN 1/1 Chafing Dish „GLOBE“



hochglanzpoliert, mit abnehmbarem hydraulischem Edelstahl-Deckel, Sandwichboden sorgt für optimale Wärmeleitung, für Induktionsplatten geeignet, Set: Gestell + Wasserbecken + Speisenbehälter GN 1/1 65 mm tief, 9 Liter + Löffelablage + 2 Brennpastenbehälter + Metallrahmen für Induktionskochplatte

mirror polished finish, removable stainless steel hydraulic cover, sandwich base for optimum heat distribution, suitable for induction plates

set: frame + waterpan + GN 1/1 container 65 mm, 9l + cutlery compartment ladles + 2 burner holder + frame for induction plate

pulido brillante, tapa hidráulica de acero inoxidable extraíble, fondo difusor sandwich apto para inducción, incluye: soporte + cubeta baño maría + cubeta GN 1/1 de 65 mm, 9 l + soporte para cuchara (sin cuchara) + 2 quemadores + marco para la placa de inducción

poli brillant, couvercle inox hydraulique amovible, fond diffuseur sandwich apte pour induction, comprend: pied support + bac bain-marie + bac GN 1/1 de 65 mm, 9 l + porte-louche (louche non incluse) + 2 brûleurs + cadre inox pour la plaque à induction

	cm	↑ cm	ltr.		€
12394	66,5 x 44	34	9	mit Edelstahldeckel with stainless cover	624,00
12404	66,5 x 44	34	9	mit Glasdeckel with glass cover	624,00

Induktionskochplatte für Chafing Dish / induction plate for chafing dish / placa de inducción para chafing dish / plaque à induction pour chafing dish

	€
12295	139,00

Metallrahmen für Induktionskochplatte / frame for induction plate / estructura o marco para placa de inducción / cadre support inox pour plaque induction

	€
12296	19,40



Suppen-Kugel inkl. Gestell „GLOBE“

soup bowl with stand
cubeta sopa con soporte
récipient à soupe avec pied

hochglanzpoliert, inkl. Speisenbehälter, 1 Brennpastenbehälter, mit einhängbarer Löffelablage, Sandwichboden sorgt für optimale Wärmeverteilung, für Induktionsplatten geeignet, einfaches Anbringen und Entfernen des Deckels, hitzeisolierende Griffe, 1 Metallrahmen für Induktionskochplatten

mirror polished finish, incl. foodpan and 1 burner holder, with fitting compartment for ladles, sandwich bottom for optimum heat distribution, gentle opening of the lid, heat-resistant handles, frame for induction plate

acabado pulido brillante, cubeta sopa inox, 1 quemador, platillo a colgar para el cucharón, fondo difusor sandwich, apto para inducción, tapa con apertura controlada, asas frías, marco para placa de inducción

poli brillant, récipient à soupe inox, 1 brûleur, repose-couvert à accrocher, fond diffuseur sandwich, apte pour induction, couvercle à ouverture contrôlée, anses froides, cadre support inox pour plaque à induction



	Ø cm	↑ cm	ltr.	€
12398	48	45	10	490,00

Induktionskochplatte für Chafing Dish / induction plate for chafing dish / placa de inducción para chafing dish / plaque à induction pour chafing dish

12295	139,00
-------	--------

Metallrahmen für Induktionskochplatten / frame for induction plate / marco para placa de inducción / cadre support inox pour plaque induction

12291	18,30
-------	-------



Suppen-Kugel „GLOBE“

soup bowl
cubeta sopa
récipient à soupe

hochglanzpoliert, inkl. Speisenbehälter, mit einhängbarer Löffelablage, Sandwichboden sorgt für optimale Wärmeverteilung, für Induktionsplatten geeignet, einfaches Anbringen und Entfernen des Deckels, hitzeisolierende Griffe (Lieferung ohne Gestell, Löffel)

mirror polished finish, incl. foodpan, with fitting compartment for ladles, sandwich bottom for optimum heat distribution, gentle opening of the lid, heat-resistant handles (delivery without rack, ladle)

acabado pulido brillante, cubeta sopa inox, platillo a colgar para el cucharón, fondo difusor sandwich, apto para inducción, tapa con apertura controlada, asas frías (cucharón no incluido)

poli brillant, récipient à soupe inox, repose-couvert à accrocher, fond diffuseur sandwich, apte pour induction, couvercle à ouverture contrôlée, anses froides (cadre, louche non incluse)



	Ø cm	↑ cm	ltr.	€
12399	48	32	10	420,00

Gestell inkl. Brenner / frame incl. burner / soporte incluyendo quemador / support, brûleur inclus

12396	90,00
-------	-------

Speisenbehälter / foodpan / cubeta superior / bac supérieur

12397	22,00
-------	-------



Chafing Dish „GLOBE“



hochglanzpoliert, mit abnehmbarem hydraulischen Edelstahl-Deckel, Sandwichboden sorgt für optimale Wärmeleitung, für Induktionsplatten geeignet

Set: Gestell + Wasserbecken + Speisenbehälter rund + Löffelablage + Brennpastenbehälter + Metallrahmen für Induktionskochplatte

mirror polished finish, removable hydraulic cover, sandwich base, optimum heat distribution set: frame + waterpan + foodpan round + cuttlery compartment ladles + burner holder + frame for induction plate

pulido brillante, con tapa hidráulica extraíble, fondo difusor sandwich apto para inducción. Incluye: 1 pie, 1 cubeta baño maria, 1 cubeta redonda, 1 soporte para cuchara (sin cuchara), 1 quemador, marco inox para la placa de inducción

brillant, couvercle hydraulique amovible, fond diffuseur sandwich apte pour induction.

Comprend: pied, cuve bain-marie, bac inox rond, porte-louche (louche non incluse), 1 brûleur, cadre inox pour la plaque à induction

	Ø cm	↑ cm	ltr.		€
12393	38,5	34	6	mit Edelstahldeckel with stainless cover	532,00
12403	38,5	34	6	mit Glasdeckel with glass cover	540,00

Induktionskochplatte für Chafing Dish / induction plate for chafing dish / placa de inducción para chafing dish / plaque à induction pour chafing dish

12295	139,00
-------	--------

Metallrahmen für Induktionskochplatten / frame for induction plate / marco para placa de inducción / cadre support inox pour plaque induction

12291	18,30
-------	-------

Speiseneinsatz / foodpan / cubeta / bac supérieur

12366	24,00
-------	-------

Porzellan-Einsatz / porcelain insert / bandeja de porcelana / bac supérieur en porcelaine

	Ø cm	↑ cm	ltr.	fits to	€
82210	39	6	4,3	12393, 12403	82,00
82215	39	6	4,0	12393, 12403	84,00



GN 2/3 Chafing Dish „GLOBE“



hochglanzpoliert, mit abnehmbarem hydraulischem Edelstahl-Deckel, Sandwichboden sorgt für optimale Wärmeleitung, für Induktionsplatten geeignet, Set: Gestell + Wasserbecken + 1 GN 2/3 Behälter 65 mm tief + Löffelablage + 1 Brennpastenbehälter + 1 Metallrahmen für Induktionskochplatte

mirror polished finish, removable hydraulic cover, sandwich base, optimum heat distribution, set: frame + waterpan + foodpan GN 2/3, 65 mm, 5,5 l + compartment for ladles + burner holder + frame for induction plate

pulido brillante, con tapa hidráulica extraíble, fondo difusor sandwich apto para inducción. Incluye: 1 pie, 1 cubeta baño maria, 1 cubeta GN 2/3 65 mm - 5,5 l, 1 soporte para cuchara (sin cuchara), 1 quemador, marco inox para la placa de inducción

poli brillant, couvercle hydraulique amovible, fond diffuseur sandwich apte pour induction. Comprend: pied, cuve bain-marie, bac inox GN 2/3-65 mm - 5,5 L, porte-louche (louche non incluse), brûleur, cadre inox pour la plaque à induction

	cm	↑ cm	ltr.		€
12483	44 x 41	34	5,5	mit Edelstahl-Deckel with stainless steel cover	560,00
12484	44 x 41	34	5,5	mit Glasdeckel with glass cover	560,00

EASY INDUCTION



die Deckelbremse sorgt für langsames Schließen

the revolving cover closes gently, thanks to a special built-in axle

sistema de freno para un cierre suave de la tapa

système avec frein pour une fermeture en douceur du couvercle



Druckhebel zum leichten Entnehmen des GN-Behälters

stick for easy removing of the GN-container

dispositivo para levantar y quitar con facilidad la cubeta GN

dispositif pour lever et retirer facilement le bac GN



abnehmbarer Glas-Deckel mit Wasserrücklaufsystem

removable glas lid, with water-runback-system

tapa transparente desmontable con sistema de retorno de la condensación

couvercle transparent amovible avec système de retour de la condensation



Fixierschraube verhindert das Rutschen

fixing screw for skid resistance

Pie trasero anti-deslizante, altura regulable

Pied supplémentaire anti-dérapant réglable en hauteur



GN 1/1 Chafing Dish „EASY INDUCTION“



1 Gestell + 1 Wasserbecken mit Sandwichboden + 1 Deckel mit hydraulischem Gelenk + 1 GN 1/1 Behälter 65 mm tief, hitzebeständige Griffe, hochwertige Verarbeitung, ausschließlich für Induktionskochfelder

1 frame + 1 waterpan with sandwich base + 1 hydraulic cover + 1 GN 1/1 container 65 mm, heat-resistant handles, high quality, only for induction plates

1 marco + 1 baño maría con base sandwich + 1 marco con tapa hidráulica + 1 cubeta GN 1/1 pan 65 mm profundo, asas resistentes al calor, buenos acabados, solamente para inducción

1 pied support + 1 bac bain-marie avec fond sandwich + 1 cadre avec couvercle hydraulique + 1 bac GN 1/1 - 65mm, poignées résistantes à la chaleur, belle qualité, uniquement pour induction

	cm	↑ cm	GN	ltr.	€
12322	60 x 42	30	1/1	9	500,00



GN 2/3 Chafing Dish „EASY INDUCTION“



1 Gestell + 1 Wasserbecken mit Sandwichboden + 1 Wasserbeckenrahmen + 1 Deckel mit hydraulischem Gelenk + 1 GN 2/3 Behälter 65 mm tief, hitzebeständige Griffe, hochwertige Verarbeitung, ausschließlich für Induktionskochfelder

1 frame + 1 waterpan with sandwich base + 1 frame for waterpan + 1 hydraulic cover + 1 GN 2/3 container 65 mm, heat-resistant handles, high quality, only for induction plates

1 marco + 1 baño maría con base sandwich + 1 marco con tapa hidráulica + 1 cubeta GN 2/3 pan 65 mm profundo, asas resistentes al calor, buenos acabados, solamente para inducción

1 pied support + 1 bac bain-marie avec fond sandwich + 1 cadre avec couvercle hydraulique + 1 bac GN 2/3 - 65mm, poignées résistantes à la chaleur, belle qualité, uniquement pour induction

	cm	↑ cm	GN	ltr.	€
12323	42 x 41	30	2/3	5,5	420,00



EASY INDUCTION



Lieferung ohne Induktionskochplatte
delivery without induction plate
se entrega sin placa de inducción
livré sans plaque à induction

Chafing Dish „EASY INDUCTION“



1 Gestell + 1 Wasserbecken mit Sandwichboden + 1 Deckel mit hydraulischem Gelenk
+ 1 runder Speisenbehälter, hitzebeständige Griffe, hochwertige Verarbeitung,
ausschließlich für Induktionskochfelder geeignet

1 frame + 1 waterpan with sandwich base + 1 hydraulic cover + 1 round foodpan,
heat-resistant handles, high quality, good for induction plates

1 soporte + 1 baño maría con base sandwich + 1 tapa hidráulica + 1 cubeta redonda,
asas resistente al calor, buen acabado, apto para inducción

1 pied support + 1 bac bain-marie avec fond sandwich + 1 cadre avec couvercle hydraulique +
1 bac rond, poignées résistante à la chaleur, belle qualité, uniquement pour induction

	cm	↑ cm	ltr.	€
12324	46 x 50	30	6	410,00



Lieferung ohne Induktionskochplatte
delivery without induction plate
se entrega sin placa de inducción
livré sans plaque à induction

Chafing Dish „EASY INDUCTION“



1 Gestell + 1 Wasserbecken mit Sandwichboden + 1 Deckel mit hydraulischem Gelenk +
1 runder Speisenbehälter, hitzebeständige Griffe, hochwertige Verarbeitung,
ausschließlich für Induktionskochfelder geeignet

1 frame + 1 waterpan with sandwich base + 1 hydraulic cover + 1 round foodpan,
heat-resistant handles, high quality, good for induction plates

1 soporte + 1 baño maría con base sandwich + 1 tapa hidráulica + 1 cubeta redonda,
asas resistente al calor, buen acabado, apto para inducción

1 pied support + 1 bac bain-marie avec fond sandwich + 1 cadre avec couvercle hydraulique +
1 bac rond, poignées résistante à la chaleur, belle qualité, uniquement pour induction

	cm	↑ cm	ltr.	€
12325	48 x 42	39	11	410,00



Induktionskochplatte für Chafing Dish

induction plate for chafing dish
placa de inducción para chafing dish
plaque à induction pour chafing dish

mit Regler

with power control

con control de potencia

avec régulateur

	Ø cm	W	€
12295	24	900 W	139,00



82210
4,3 ltr.

82215
2 x 2 ltr.

Porzellan-Einsatz

porcelain insert
bandeja de porcelana

bac supérieur en porcelaine



	Ø cm	↑ cm	ltr.	fits to	€
82210	39	6	4,3	12324, 12393, 12403	82,00
82215	39	6	4,0	12324, 12393, 12403	84,00



Die Induktionsstation mit Regler präsentiert sich in einem Set aus Walnussholz, einem schwarzen Metallständer und einer Induktionsheizung.

The induction station with controller is presented in a set of walnut wood, a black metal stand and an induction heater.

La estación de inducción con regulador se presenta en un set formado por una caja de madera de nogal, un soporte de metal negro y un calentador de inducción.

La station à induction avec température réglable se compose d'un caisson en bois noyer, d'un support métallique noir et d'une plaque à induction.



Induktionsstation, 4-tlg. Set
induction station, 4 pcs.
estación de inducción, set de 4
station d'induction, set de 4



4 teiliges Set:

- 1 Induktionskochplatte mit Regler (Ø 24 cm, 900 Watt)
- 1 Metallständer schwarz
- 1 Rahmen aus Walnussholz geölt
- 1 Edelstahlrahmen

4 pcs. set:

- 1 induction hotplate with controller (Ø 24 cm, 900 Watt)
- 1 metal stand black
- 1 frame in oiled walnut wood
- 1 stainless steel frame

set de 4:

- 1 placa de inducción con regulador (Ø 24 cm, 900 vatios)
- 1 soporte de metal negro
- 1 caja de madera de nogal aceitada
- 1 marco de acero inoxidable

set de 4:

- 1 plaque d'induction avec température réglable (Ø 24 cm, 900 watts)
- 1 support métallique noir
- 1 caisson en bois noyer huilé
- 1 cadre en acier inox

	cm	↑ cm	€/set
12270	35,4 x 32,5	19	210,00



passendes Chafing Dish Set 12330
suitable chafing dish set 12330

Ersatzteile / replacement parts / piezas de repuesto / pièces de rechange

	cm	↑ cm		€
12271	35,4 x 32,5	8,5	Holzrahmen / wooden frame	54,00
12272	29,5 x 26,5	1	Edelstahlrahmen / stainless steel frame	22,00
12295	Ø 24	-	900 Watt Induktionskochplatte / induction plate	139,00
15506	35,4 x 32,5	17,6	Buffetständer schwarz / buffet stand black	22,80



Chafing Dish, 4-teiliges Set

chafing dish set, 4 pcs.
chafing dish, set de 4
chafing dish, set de 4



4-teiliges Set:

- 1 Topf (8 Liter)
- 1 Speisenbehälter (4 Liter)
- 1 Deckel mit Sichtfenster und 1 Deckelbremse,
- Topf mit induktionsfähigem Sandwich- / Kapselboden

4 pcs. set:

- 1 pot (8 litres),
- 1 foodpan (4 litres)
- 1 lid with glass insert and 1 automatic lid brake
- pot with induction-compatible sandwich base

set de 4:

- 1 olla (8 litros)
- 1 cubeta (4 litros)
- 1 tapa con ventanilla y 1 sistema de freno en la tapa
- olla con base sandwich apta para inducción

set de 4:

- 1 casserole (8 litres)
- 1 bac (4 litres)
- 1 couvercle avec fenêtre et 1 système de frein dans le couvercle
- casserole avec fond sandwich pour induction

	Ø cm	↑ cm	ltr.	Farbe / Colour		€/ set
12330	30,5	17,5	4		stainless	260,00
12335	30,5	17,5	4		copper	314,00
12336	30,5	17,5	4		yellow	314,00
12337	30,5	17,5	4		red	314,00
12338	30,5	17,5	4		black	314,00



abnehmbarer Deckel
removable lid

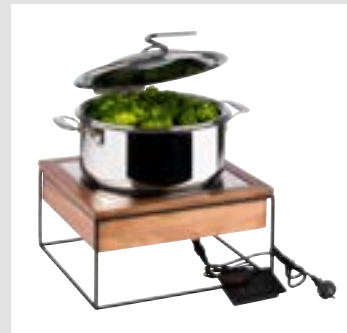

induktionsgeeignet
suitable for induction

Ersatz-Speisenbehälter zu Chafing Dish / replacement foodpan for chafing dish / cubeta interior de repuesto para chafing dish / bac intérieur de remplacement pour le chafing dish

	Ø cm	↑ cm	ltr.	fits to	€
12329	30,5	8	4	12330, 12335, 12336, 12337, 12338	30,00



8 ltr. Topf
8 ltr. pot



Sandwich- / Kapsel-
boden / sandwich base



4 ltr. Speisenbehälter
4 ltr. foodpan



Deckelbremse
automatic lid break



12329

4 ltr.



Rolltop-Chafing Dish „MAESTRO“



Speisenbehälter GN1/1 65 mm tief (passend auch für 100 mm) + Rolltopdeckel 90° + Wasserbecken inkl. Vorrichtung für Heizplatte + 2 Brennpastenbehälter
 foodpan GN1/1 65 mm (also for 100 mm) + rolltop cover 90° + waterpan with screws for heating unit + 2 burner holders
 cubeta GN 1/1 - 65 mm (hay espacio para una cubeta 100 mm) + campana rolltop abatible a 90° + 2 quemadores
 bac GN 1/1 - 65 mm (accepte aussi bac ht. 100 mm) + couvercle rolltop ouverture 90° + 2 brûleurs

	cm	↑ cm	ltr.	€
12300	67 x 35	45	9	200,00



Rolltopdeckel 90°
rolltop cover 90°



Präsentationsmöglichkeit
presentation example



Rolltop-Chafing Dish „ELITE“



poliert, Rolltopdeckel klappbar auf 90° und 180°, Speisenbehälter GN 1/1 65 mm tief + Wasserbecken + 2 Brennpastenbehälter, wechseln des GN-Behälters ohne Abnehmen des Deckels (kein Kondenswasser-Rücklaufsystem)
 polished, rolltop cover adjustable at 90° and 180°, foodpan GN 1/1 65 mm deep + waterpan + 2 burner holders, change of the GN container without removing the lid (condensed water can not be led back into the waterpan)
 pulido brillante, tapa rolltop a 90° o 180°, cubeta GN 1/1 + 2 quemadores, cuba baño maría, se puede cambiar la cubeta GN sin retirar la tapa, importante: el agua condensada no revierte en los alimentos
 poli brillant, couvercle rolltop ouverture de 90 a 180°, bac GN 1/1, bain-marie, 2 brûleurs, le bac GN peut être retiré et remplacé sans démonter le couvercle, important: la condensation ne retombe pas sur les aliments

	cm	↑ cm	ltr.	€
12350	67 x 47	45	9	250,00

Wasserbecken inkl. Vorrichtung für Heizelement / waterpan / baño maría / bain-marie

	€
12249	49,00



inkl. Vorrichtung für Heizelement
incl. screws for heating unit

CHAFING DISHES



inkl. Vorrichtung
für Heizelement
incl. screws
for heating unit

Rolltop-Chafing Dish „CATERER“



Speisenbehälter GN 1/1 65 mm tief + Rolltopdeckel 90° + Wasserbecken inkl. Vorrichtung für Heizplatte + 2 Brennpastenbehälter (Lieferung ohne Heizplatte), massiver Ständer
foodpan GN 1/1 65 mm deep + rolltop cover 90° + waterpan with screws for heatingunit + 2 burner holders (without heating unit), stable frame
1 cubeta GN 1/1 - 65 mm + campana rolltop abatible a 90° + 2 quemadores + cuba baño maría con fijaciones para resistencia amovible (se sirve sin la resistencia)
1 bac GN 1/1 - 65 mm + couvercle rolltop ouverture 90° + 2 brûleurs + 1 bac bain-marie avec 4 vis pour fixation résistance de chauffe amovible (non include)

	cm	↑ cm	ltr.	€
12245	67 x 35	45	9	228,00

Wasserbecken inkl. Vorrichtung für Heizelement / waterpan / baño maría / bain-marie

12249				49,00
-------	--	--	--	-------



Chafing Dish „CATERER PRO“



Deckel hochglanzpoliert, Deckelgriffe hitzebeständig + 2 Brennpastenbehälter + Wasserbecken, inkl. Vorrichtung für Heizplatte + Gestell mit Deckelhalterung (ohne GN Speisenbehälter)
cover mirror polished finish, cover knob heat-resistant + 2 burner holders + waterpan with screws for heating unit + frame with coverholder (without GN foodpan)
tapa pulido brillante, asas frías + 2 quemadores + cuba inferior con tornillos para resistencia removible (no incluida) + tapa y estructura con sujeción de la tapa (se sirve sin la cubeta GN)
couvercle poli brillant, anses froides + 2 brûleurs + bac bain-marie avec fixations pour résistance amovible (non include)

	cm	↑ cm	€
12233	64 x 35	34	150,00

Ersatzdeckel / replacement cover / tapa de recambio / couvercle de rechange

12236			52,00
-------	--	--	-------

Wasserbecken inkl. Vorrichtung für Heizelement / waterpan / baño maría / bain-marie

12249			49,00
-------	--	--	-------



Chafing Dish „CHEF“



Speisenbehälter GN 1/1 65 mm tief + 2 Brennpastenbehälter + Wasserbecken + Deckel + Gestell mit Deckelhalterung + langer Hohlgriff
foodpan GN 1/1 65 mm + 2 burner holders + waterpan + cove + frame with coverholder
1 cubeta GN 1/1 65 mm + 2 quemadores + cubeta para el agua + tapa y chasis con bloqueo para la tapa
1 bac GN 1/1 - 65 mm + 2 brûleurs + 1 bac bain-marie + couvercle + chasis avec blocage couvercle + poignée tube creux

	cm	↑ cm	ltr.	€
11675	61 x 31	30	9	74,00



GN 1/1 100 mm
14 ltr.

Elektro-Rolltop-Chafing Dish „ELITE“

electric rolltop chafing dish
chafing dish eléctrico rolltop
chafing dish électrique rolltop



poliert, Rolltopdeckel klappbar auf 90° und 180°, Elektro-Wasserbecken mit Temperaturregung + Speisenbehälter GN 1/1 100 mm tief, 220 - 240 V ~ 50 Hz; 760 - 900 W (kein Kondenswasser-Rücklaufsystem)

polished, rolltop cover adjustable at 90° and 180°, electric waterpan with adjustable heatcontrol + foodpan GN 1/1 100 mm deep, voltage 220 - 240 V ~ 50 Hz, power consumption 760-900 W (condensed water cannot be led back into the waterpan)

pulido brillante, tapa abatible apertura a 90° o 180°, baño maría c/ termostato + cubeta GN 1/1 - 100 mm, 220-240 V-50 Hz. Consumo 760-900 W (el agua condensada no gotea dentro de la cubeta)

poli brillant, couvercle rolltop ouverture à 90° ou 180°, bain-marie électrique avec thermostat + bac GN 1/1-100 mm, 220-240 V - 50 Hz; 760-900 W (Important: la condensation ne retombe pas sur les aliments)

	cm	↑ cm	ltr.	€
12360	67 x 47	45	14	395,00



Elektrischer Suppentopf „ECONOMIC“

electric soup warmer
marmita de sopa eléctrica
marmite à soupe électrique



Stahl schwarz lackiert, herausnehmbarer Einsatz aus Edelstahl, Temperaturregelung 30°C - 90°C, dreh- und klappbarer Edelstahl-Deckel, inkl. 8 magnetisch haftenden Beschriftungen, 400 W / 230 V

metal, black, removable soup pot, thermostat 30°C - 90°C, st. steel lid, incl. 8 magnetic signs, 400 W / 230 V

metal negro, recipiente sopa inox extraíble, termostato 30°C- 90°C, tapa inox, incluye 8 letreros magnéticos, 400 W / 230 V

acier, noir, récipient à soupe amovible, thermostat 30°C - 90°C, couvercle inox, 8 étiquettes magnétiques, 400 W / 230 V

	Ø cm	↑ cm	ltr.	€
11915	32	36	9	104,00

Speisenbehälter / foodpan / recipiente sopa / récipient à soupe

11916	28,00
-------	-------

Deckel / cover / tapa / couvercle

11917	15,40
-------	-------



Elektro Chafing Dish

electric chafing dish
chafing dish eléctrico
chafing dish électrique



Speisenbehälter GN 1/1 100 mm tief, Deckelhalter, Thermostat-Regelung 900 W, 230 V

foodpan GN 1/1 100 mm deep, lid holder, thermostat control 900 W, 230 V

cubeta GN 1/1-100 mm, sujeción de la tapa, termostato, 900W, 230 V

bac GN 1/1-100 mm, blocage du couvercle, thermostat, 900W, 230 V

	cm	↑ cm	ltr.	€
12225	63 x 36	29	14	170,00

Deckel / cover / tapa / couvercle

12235	35,00
-------	-------

CHAFING DISHES



Elektro-Chafing Dish „ECO“

electric chafing dish
chafing dish eléctrico
chafing dish électrique



Deckel poliert, Elektro-Wasserbecken mit Temperaturregelung + Speisenbehälter GN 1/1
65 mm tief, 220 - 240 V ~ 50 Hz; 760 - 900 W

cover polished, electric waterpan with adjustable heatcontrol + foodpan GN 1/1 65 mm deep,
voltage 220 - 240 V ~ 50 Hz, power consumption 760 - 900 W

tapa pulido brillante, baño maría c/ termostato + cubeta GN 1/1 - 65 mm - 220-240 V-50 Hz. /
760-900 W

couvercle poli brillant, bain-marie électrique avec thermostat + bac GN 1/1-65 mm, 220-240
V - 50 Hz; 760-900 W

	cm	↑ cm	ltr.	€
12232	63 x 36	29	9	139,00



Elektrischer Suppentopf

electric soup warmer
marmita de sopa eléctrica
marmite à soupe électrique



herausnehmbarer Einsatz aus Edelstahl, elektrisch, mit Wasserbad + Löffel + integrierter
Tragering für den Innenbehälter, Deckel mit hitzeisolierendem Griff, Temperaturregelung
80°C (± 10°C), 450-550 W, 230 V

removable soup st. steel pan, bain marie electric, ladle, circular frame,
thermostat control till 80°C (± 10°C), 450-550 W, 230 V

recipiente sopa inox extraíble, baño maría eléctrico + cucharón + aro inox, tapa con asas frías,
termostato hasta 80°C precisión (± 10°C), 450-550 W, 230 V

réceptif à soupe inox amovible, bain-marie électrique, louche, support circulaire inox, ther-
mostat maxi 80°C (± 10°C), 450-550 W, 230 V

	Ø cm	↑ cm	ltr.	€
11901	38	36,5	10	148,00



Elektrischer Suppentopf

electric soup warmer
marmita de sopa eléctrica
marmite à soupe électrique



herausnehmbarer Einsatz aus Edelstahl, elektrisch, mit Wasserbad + Löffel + integrierter
Tragering für den Innenbehälter, Deckel mit hitzeisolierendem Griff, Temperaturregelung
80°C (± 10°C), 400 - 450 W / 220 - 240 V

removable soup st. steel pan, bain marie electric, ladle, st. steel circular frame,
thermostat control till 80°C (± 10°C), 400 - 450 W / 220 - 240 V

recipiente sopa inox extraíble, baño maría eléctrico + cucharón + aro inox,
tapa con asas frías, termostato hasta 80°C precisión (±10°C) , 400 - 450 W / 220 - 240 V

réceptif à soupe inox amovible, bain-marie électrique, louche, support circulaire inox, ther-
mostat maxi 80°C (± 10°C), 400 - 450 W / 220 - 240 V

	Ø cm	↑ cm	ltr.	€
11910	40	37	10	148,00

TWO IN ONE



Fondue

Feuerzange

13 tlg. Set
13 pcs. set

CHAFING DISH • GN CONTAINER • TRANSPORT



2,2 ltr.

65060

65061

6 Stk.
6 pcs.

65062

Fondue und Feuerzangenbowle-Set „TWO IN ONE“

fondue and fire punch bowl set
set para fondue o ponche caliente
service à fondue et à punch

13-teiliges Set aus Edelstahl bestehend aus:

1 Topf, 1 Rechaud, 1 Spritzschutz, 1 Untersetzer, 1 Schöpfkelle, 1 Feuerzange,
1 Pastenbrenner, 6 Fonduegabeln

13-piece stainless steel set consisting of:

1 pot, 1 rechaud, 1 splash guard, 1 coaster, 1 ladle, 1 fire tongs,
1 paste burner, 6 fondue forks

set de 13 piezas de acero inoxidable compuesto por:

1 olla, 1 rechaud, 1 protector contra salpicaduras, 1 trébede, 1 cazo,
1 pinza para el fuego, 1 quemador de pasta, 6 tenedores de fondue

set de 13 pièces en acier inox comprenant:

1 marmite, 1 rechaud, 1 pare-éclaboussures, 1 dessous de plat, 1 louche, 1 pince à feu,
1 brûleur à pâte, 6 fourchettes à fondue



	Ø cm	↑ cm	ltr.	€ / set
65060	22	23	2,2	54,00

Brennpastenbehälter zu 65060

fuel paste container for 65060

recipiente para pasta de combustible para 65060

réipient pour pâte à combustible pour 65060



	cm	↑ cm	fits to	€
65061	26 x 12	10	65060	7,00

Gabelset zu 65060

fork set for 65060

set de tenedores para 65060

set de fourchettes pour 65060



	cm	→ cm	pcs.	fits to	€ / set
65062	24	Griff / handle 8	6	65060	8,00



Kaffeedispenser „HAPPY HOUR“

coffee dispenser
dispensador de café
distributeur de café



hochglanzpoliert, für warme Getränke, stabil und standfest, inkl. 1 Brennpastenbehälter
mirror polished finish, for warm drinks, solid and stable, incl. 1 burner holder
acabado pulido brillante para bebidas calientes, sólido y estable, incluye un calentador
brillant, pour boissons chaudes, avec 1 brûleur, robuste et stable

	cm	↑ cm	ltr.	€
11672	31 x 33,5	54,5	10,5	210,00

Hahn / tap / grifo / robinet

	€
11671	27,00

Elektro-Heizelement / heating unit / resistencia / résistance

	cm	↑ cm	€
12287	21 x 20	6	99,00



Rolltophaube „SWISS“

rolltop-cover
campana rolltop
cloche rolltop



hochglanzpoliert, klappbar auf 90°, nachrüstbar für alle handelsüblichen Chafer
mirror polished finish, cover adjustable at 90°, usable for all commercial chafing dishes
pulido brillante, tapa ajustable 90°, apto para todos los chafings profesionales
poli brillant, ouverture réglable à 90°, apte pour tous les chafings professionnels

	cm	↑ cm	€
12310	55 x 34	19,5	96,00



Bain-Marie Topf

bain marie pot
olla baño Maria
marmite bain-marie



inkl. Deckel, mit Löffelaussparung
included cover, notched for spoon
incluye tapa con hueco para la cuchara
includ le couvercle avec espace pour la louche

	Ø cm	↑ cm	ltr.	€
12244	20	18	4,5	29,00

Deckel / cover / tapa / couvercle

	€
11244	9,00



Bain-Marie Deckel

cover for bain marie
tapa del baño maría
couvercle du bain-marie



	cm	€
12243	54 x 33,5	29,00



Einbau-Induktionskochplatte für Chafing Dish

built-in induction plate for chafing dish
placa de inducción para empotrar
plaque à induction à encastrer

inkl. Kabel-Fernbedienung, energiesparend, Leistung in 5 Stufen regelbar

incl. cable remote control, energy-saving, power adjustable in 5 steps
incl. mando a distancia con cable, ahorro energético, potencia regulable en 5 pasos
y compris télécommande filaire, économe en énergie, puissance réglable en 5 étapes

	cm	↑ cm		€
12285	35,5 x 35,5	6	2000 W	210,00



Induktionskochplatte für Chafing Dish

induction plate for chafing dish
placa de inducción para chafing dish
plaque à induction pour chafing dish

inkl. Kabel-Fernbedienung, energiesparend, Leistung in 5 Stufen regelbar

incl. cable remote control, energy-saving, power adjustable in 5 steps
incl. mando a distancia con cable, ahorro energético, potencia regulable en 5 pasos
y compris télécommande filaire, économe en énergie, puissance réglable en 5 étapes

	Ø cm			€
12295	24		900 W	139,00



12291

Metallrahmen für Induktionskochplatten

frame for induction plate
marco para placa de inducción
cadre support inox pour plaque induction



			€
12291	für runde Chafer / for round chafing dish		18,30
12296	für Chafer GN 1/1 / for GN 1/1 chafing dish		19,40



Elektro-Heizelement

heating unit
resistencia
résistance



für Kaffeedispenser (Nr. 11672), 500 W, 220 V, einfach in das Gestell des Dispensers legen
for coffee dispenser (no. 11672), 500 W, 220 V, insert into the frame of the dispenser
para dispensador de café (11672), 500 W, 220V, directamente en el pie del dispensador
pour distributeur à café (11672), 500 W, 220 V, directement dans le support

			€
12287	500 W / 220 V		99,00



Heizplatte durch Spiralfeder an Wasserbad gedrückt
Heating plate is pressed against the water bath by a spiral spring

Mobile Chafing Dish Heizung

heating element
resistencia
résistance



für alle marktgängigen Chafing Dishes
suitable for all current popular chafing dishes, with special spring
para todos los chafing dish más corrientes
pour la plupart des chafing dish les plus courants

	Ø cm	↑ cm		€
12299	14	9 - 11	500 W / 220 V	42,00

HEATING UNITS | WARMERS



Elektro-Heizelement
 heating unit
 resistencia
 résistance

for chafer covers are open most of the time

ALU ALUMINIUM Made in Germany

12290	360 W / 140 - 250 V	132,00
-------	---------------------	--------



Elektro-Heizelement
 heating unit
 resistencia
 résistance

for chafer covers are open most of the time

ALU ALUMINIUM Made in Germany

12292	600 W / 230 V	136,00
-------	---------------	--------



Elektro-Heizelement
 heating unit
 resistencia
 résistance

for chafer covers are open most of the time

ALU ALUMINIUM Made in Germany

12294	800 W / 230 V	180,00
-------	---------------	--------



Brennpastenbehälter
 burner holder
 quemador
 brûleur

mit Bajonettverschluss / bayonet lock / cierre de bayoneta / verrouillage par baïonnette

EDELSTAHL STAINLESS INOX

11683	Ø cm	↑ cm	€
	9	6	6,30



Speisenwärmer
 warmer
 calienta platos
 chauffe-plat

3-flammig / 3 lights / 3 velas / 3 bougies

GLAS GLASS METALL VERCHROMT

35065	cm	↑ cm	€
	34 x 18	6	18,70



Speisenwärmer
 warmer
 calienta platos
 chauffe-plat

2-flammig / 2 lights / 2 velas / 2 bougies

EDELSTAHL STAINLESS INOX

35343	cm	↑ cm	€
	34 x 13	6	14,20



Wärme-Kies

granite chips
granulado térmico
gravier thermique

für Chafing Dishes, feine Körnung, hohe Wärmespeicherung, kein Verkleben,
ideal zum Warmhalten von Eiern

fine for chafing dishes and clean granite chippings, ideal for keeping eggs warm
gravilla de granito fina limpia, ideal para mantener los huevos calientes
gravier fin de granit, lavé, idéal pour maintenir les oeufs au chaud



	kg	€
81116	7	19,00



82274

Präsentationsmöglichkeit
presentation example



Besteckablage

cutlery rest
reposa cuchara
pose-cuillère



	cm	↑ cm	€
00650	27 x 11	3,5	8,60



Besteckablage „SMALL WAVE“

cutlery rest
reposa cuchara
pose-cuillère



	cm	↑ cm	€
83897	26 x 13	4,5	10,90



Besteckablage „BOWL“

cutlery rest
reposa cuchara
pose-cuillère



	cm	↑ cm	ltr.	€
83803	22,5 x 11	6	0,5	7,80



Besteckablage „SPOON“

cutlery rest
reposa cuchara
pose-cuillère



	cm	↑ cm	€
83801	26 x 10,5	5	7,40

GN-CONTAINERS

GN-Behälter Größen nach EN 631

Alle Behälter sind aus rostfreiem Chrom-Nickel-Edelstahl mit elektrolytisch polierter (seidenmatt) Oberfläche und somit perfekt geeignet für den professionellen Einsatz.

GN-container according to EN 631

All pans are made of chrome/nickel stainless steel with a surface polished by electrolysis (satin-matt) and therefore highly suitable for professional operation.

De conformidad con la norma europea EN 631.

Todos los contenedores están fabricados en acero inoxidable cromado/niquelado con su superficie (satinada) pulida por electrolisis lo que la hace altamente apropiado para el uso profesional.

Bacs GN- Conforme à la norme EN 631

Tous les bacs sont fabriqués en inox/chrome/nickel, surface polie électrolythique (satiné). Approprié pour usage professionnel.

Vorteile der rund geprägten U-Ecken:

- erhöhte Stabilität durch verstärktes Profil
- zielgerechtes und sauberes Ausgießen
- genaue Positionierung der GN-Behälter
- superleichtes Stapeln und Entstapeln
- kein Verklemmen der GN-Behälter
- hohe Stoßfestigkeit durch robuste Konstruktion
- ansprechendes Design und stilvoller Blickfang

Advantages of the round-shaped U-Corners:

- increased stability due to the unique construction
- clean ladling and pouring
- exact positioning of the containers
- improved shock-resistance
- appealing design
- no seize of the containers

Ventajas de las esquinas en U:

Perfil reforzado que confiere mayor rigidez y resistencia a la cubeta, diseño para verter fácil y limpiamente, fáciles de apilar y desapilar sin que se claven entre sí, construcción más robusta y resistente a los golpes mecánicos, diseño elegante.

Avantages et fonctionnalité des angles en U:

Profil renforcé pour une meilleure consistance et rigidité du récipient, design qui facilite un versage propre et aisé, permet un empilage et désempilage faciles sans que les bacs restent coincés, meilleure résistance aux chocs mécaniques, seign élégant.

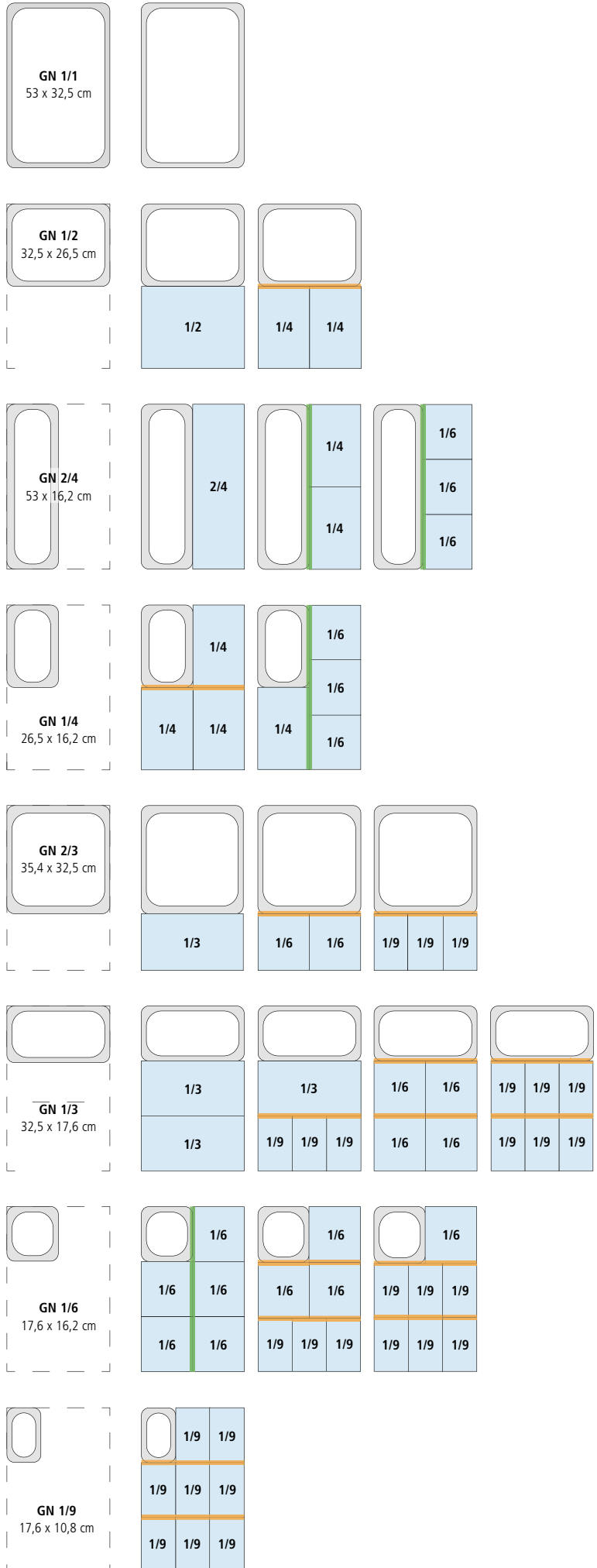



GN-Behälter

GN-container

GN cubetas

GN bacs



	GN	↓ mm	ltr.	cm	€
81000	2/1	20	5,0	53,0 x 65,0	38,80
81095	1/1	10	1,25	53,0 x 32,5	13,90
81100	1/1	20	2,5	53,0 x 32,5	15,60
81101	1/1	40	5,0	53,0 x 32,5	17,50
81109	1/1	55	6,5	53,0 x 32,5	18,30
81102	1/1	65	9,0	53,0 x 32,5	18,60
81104	1/1	100	13,25	53,0 x 32,5	22,90
81106	1/1	150	20,0	53,0 x 32,5	34,50
81108	1/1	200	25,0	53,0 x 32,5	41,80

	GN	↓ mm	ltr.	cm	€
81200	1/2	20	1,0	32,5 x 26,5	6,40
81201	1/2	40	2,0	32,5 x 26,5	9,60
81209	1/2	55	2,8	32,5 x 26,5	9,90
81202	1/2	65	4,0	32,5 x 26,5	10,20
81204	1/2	100	6,0	32,5 x 26,5	13,80
81206	1/2	150	8,75	32,5 x 26,5	21,70
81208	1/2	200	11,65	32,5 x 26,5	28,00

	GN	↓ mm	ltr.	cm	€
81300	1/3	20	0,75	32,5 x 17,6	5,00
81302	1/3	65	2,5	32,5 x 17,6	7,70
81304	1/3	100	4,0	32,5 x 17,6	10,90
81306	1/3	150	5,7	32,5 x 17,6	14,80
81308	1/3	200	7,0	32,5 x 17,6	19,60

	GN	↓ mm	ltr.	cm	€
81400	1/4	20	0,5	26,5 x 16,2	5,20
81401	1/4	40	1,0	26,5 x 16,2	5,90
81402	1/4	65	1,8	26,5 x 16,2	7,00
81404	1/4	100	2,8	26,5 x 16,2	9,30
81406	1/4	150	4,0	26,5 x 16,2	14,30
81408	1/4	200	5,5	26,5 x 16,2	17,80

	GN	↓ mm	ltr.	cm	€
81602	1/6	65	1,0	17,6 x 16,2	5,10
81604	1/6	100	1,6	17,6 x 16,2	7,00
81606	1/6	150	2,4	17,6 x 16,2	11,30
81608	1/6	200	3,0	17,6 x 16,2	13,90

	GN	↓ mm	ltr.	cm	€
81502	1/9	65	0,6	17,6 x 10,8	3,80
81504	1/9	100	1,0	17,6 x 10,8	5,70
81506	1/9	150	1,5	17,6 x 10,8	8,10

	GN	↓ mm	ltr.	cm	€
81700	2/3	20	1,5	35,4 x 32,5	11,20
81701	2/3	40	3,0	35,4 x 32,5	14,80
81702	2/3	65	5,5	35,4 x 32,5	17,10
81704	2/3	100	8,4	35,4 x 32,5	22,60
81706	2/3	150	12,5	35,4 x 32,5	32,60
81707	2/3	200	18,0	35,4 x 32,5	35,20

	GN	↓ mm	ltr.	cm	€
81800	2/4	20	1,2	53,0 x 16,2	9,40
81801	2/4	40	2,4	53,0 x 16,2	12,30
81802	2/4	65	3,6	53,0 x 16,2	14,40
81804	2/4	100	5,6	53,0 x 16,2	20,10
81806	2/4	150	8,7	53,0 x 16,2	23,40

GN-CONTAINERS



perforierte GN-Behälter

perforated GN-container
cubetas GN perforadas
bacs GN perforés



	GN	↓ mm	cm	€
81911	1/1	40	53,0 x 32,5	18,30
81907	1/1	65	53,0 x 32,5	18,60
81908	1/1	100	53,0 x 32,5	22,90
81909	1/1	150	53,0 x 32,5	34,50
81910	1/1	200	53,0 x 32,5	41,80
81901	1/2	65	32,5 x 26,5	10,20
81902	1/2	100	32,5 x 26,5	13,80
81903	1/2	150	32,5 x 26,5	21,70
81904	1/2	200	32,5 x 26,5	28,00
81905	2/3	65	35,4 x 32,5	17,10
81906	2/3	100	35,4 x 32,5	22,60



GN-Behälter Set, 4 teilig

GN-container, 4 pcs.
GN cubetas, set de 4
GN bacs, set de 4



bestehend aus: Edelstahlbehälter 1x GN 1/2 + 2x GN 1/4 + 1 Adapter

consisting of: stainless steel containers 1x GN 1/2 + 2x GN 1/4 + adapter

consiste en: cubetas de acero inoxidable 1x GN 1/2 + 2x GN 1/4 + adaptador

composé de: bacs en acier inox 1x GN 1/2 + 2x GN 1/4 + adaptateur

	GN	↓ mm	ltr.	cm	pcs	€ / set
81850	1/2	65	4	32,5 x 26,5	1	26,60
	1/4	65	1,8	26,40 x 16,2	2	
	Adapter			31,5	1	

**GN-Deckel**

GN-lid
GN tapa
GN couvercle

**ohne Löffelaussparung**

without notched edge for spoons
sin agujero para cucharón
sans espace pour louche

	GN	cm	€
81195	1/1	53,0 x 32,5	14,40
81295	1/2	32,5 x 26,5	7,40
81395	1/3	32,5 x 17,6	5,60
81495	1/4	26,5 x 16,2	5,20
81695	1/6	17,6 x 16,2	3,10
81591	1/9	17,6 x 10,8	3,20
81795	2/3	35,4 x 32,5	15,80
81895	2/4	53,0 x 16,2	11,40

**GN-Deckel**

GN-lid
GN tapa
GN couvercle

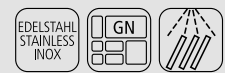
**mit Löffelaussparung**

with notched edge for spoons
con agujero para cucharón
avec espace pour louche

	GN	cm	€
81191	1/1	53,0 x 32,5	15,60
81292	1/2	32,5 x 26,5	8,20
81391	1/3	32,5 x 17,6	6,30
81492	1/4	26,5 x 16,2	5,90
81692	1/6	17,6 x 16,2	3,50
81595	1/9	17,6 x 10,8	3,30
81791	2/3	35,4 x 32,5	17,10
81891	2/4	53,0 x 16,2	12,70



Die Löffelaussparung mit Prägung verhindert das Zurückfließen von Flüssigkeit auf dem Deckel in den Behälter.

The notch for spoon with embossing prevents liquid on the lid from flowing back into the container.

GN-CONTAINERS



GN Transport-Steck-Deckel

GN-lid with silicone seal
GN tapa hermética con junta
GN couvercle hermétique avec joint



Silikondichtung, Griffmulde und Loch gegen Unterdruck, schwappsicherer Transport nicht für Kombidämpfer geeignet

silicone joint, flat handle, vent to compensate, slosh-proof transport, for pressure, not usable for steam oven
junta de silicona, asa empotrada, válvula para compensar, transporte sin salpicaduras, la presión, no se puede utilizar en hornos de vapor
joint silicone, anse encastrée, valve pour compenser la pression, transport sans éclaboussures, ne convient pas pour les étuves combinées

	GN	cm	€
80023	1/1	53,0 x 32,5	38,60
80024	1/2	32,5 x 26,5	24,00
80025	1/3	32,5 x 17,6	21,00
80026	1/4	26,5 x 16,2	18,00
80027	1/6	17,6 x 16,2	14,80
80028	2/4	53,0 x 16,2	34,80
80029	2/3	35,4 x 32,5	37,40



Adapter / Zwischensteg

adapter
adaptador
adaptateur



ermöglicht stabilen Halt von GN-Behältern im CD, rostfreier Chrom-Nickel-Edelstahl

for fixing GN pans, chrome / nickel stainless steel
para sujetar las cubetas GN, acero inox
support stable pour les bacs GN

	cm	€	
81996	15,9	längs bei GN 1/4 / lengthwise GN 1/4 longitud GN 1/4 / GN 1/4 dans la longueur	1,80
81997	17,6	längs bei GN 1/9 / lengthwise GN 1/9 longitud GN 1/9 / GN 1/9 dans la longueur	2,00
81999	32,5	quer bei GN 1/2 / crosswise GN 1/2 de ancho GN 1/2 / GN 1/2 dans la largeur	3,20
81998	52,5	längs bei GN 1/1 / lengthwise GN 1/1 longitud GN 1/1 / GN 1/1 dans la longueur	5,50



GN Abtropfgitter

GN-drainer
GN escurridor
GN égouttoir



Abtropfgitter aus Edelstahl für Gastronorm Behälter, passend für GN 1/1 und GN 1/2

stainless steel GN drainer for GN 1/1 + GN 1/2
escurridor GN de acero inoxidable para GN 1/1 + GN 1/2
égouttoir GN en acier inoxydable pour GN 1/1 + GN 1/2

	GN	cm	↑ cm	€
81117	1/1	45 x 25	1,5	22,00
81118	1/2	25 x 19	1,5	16,00

**GN-Behälter aus Polypropylen**

GN-container polypropylene
GN cubetas polipropileno
GN bacs polypropilène

**transparent: Skalierung in Liter, robust und formstabil**

transparent: liter scale, solid quality

transparente: graduación en litros, alta calidad

transparent: graduation en litres, haute-qualité

	GN	↓ mm	ltr.	cm	€
82104	1/1	65	8,5	53 x 32,5	10,20
82106	1/1	100	13,0	53 x 32,5	11,70
82108	1/1	150	19,5	53 x 32,5	13,30
82110	1/1	200	26,0	53 x 32,5	16,30
	GN	↓ mm	ltr.	cm	€
82112	1/2	65	3,9	32,5 x 26,5	5,50
82114	1/2	100	5,9	32,5 x 26,5	6,30
82116	1/2	150	8,9	32,5 x 26,5	7,80
82117	1/2	200	11,8	32,5 x 26,5	9,00
	GN	↓ mm	ltr.	cm	€
82118	1/3	65	2,4	32,5 x 17,5	4,60
82120	1/3	100	3,6	32,5 x 17,5	5,30
82122	1/3	150	5,3	32,5 x 17,6	6,90
82123	1/3	200	7,0	32,5 x 17,6	7,90
	GN	↓ mm	ltr.	cm	€
82128	1/4	65	1,7	26,5 x 16,2	3,80
82130	1/4	100	2,5	26,5 x 16,2	4,40
82132	1/4	150	3,7	26,5 x 16,2	5,80
82134	1/4	200	4,8	26,5 x 16,2	9,20
	GN	↓ mm	ltr.	cm	€
82136	1/6	65	1,0	17,6 x 16,2	3,20
82138	1/6	100	1,5	17,6 x 16,2	3,70
82140	1/6	150	2,2	17,6 x 16,2	4,30
82142	1/6	200	2,8	17,6 x 16,2	7,80
	GN	↓ mm	ltr.	cm	€
82150	1/9	65	0,6	17,6 x 10,8	3,00
82151	1/9	100	1,0	17,6 x 10,8	3,20



stapelbar
stackable



Skalierung
scaling

**GN-Deckel**

GN-lid
GN tapa
GN couvercle



	GN	cm	€
82101	1/1	53,0 x 32,5	5,70
82113	1/2	32,5 x 26,5	3,40
82119	1/3	32,5 x 17,6	2,90
82129	1/4	26,5 x 16,2	2,80
82137	1/6	17,6 x 16,2	2,70
82159	1/9	17,6 x 10,8	2,60

GN-CONTAINERS



GN-Behälter aus Polycarbonat

GN-container polycarbonate
GN cubeta policarbonato
GN bac polycarbonate

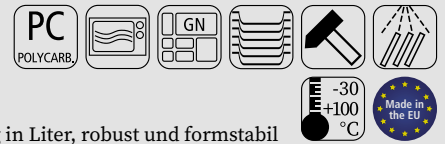

transparent: Inhalt gut erkennbar, Skalierung in Liter, robust und formstabil

transparent: content can be seen, liter scale, solid quality

transparente para ver el contenido, graduación en litros, alta calidad

transparent pour voir le contenu, graduation en litres, haute-qualité

	GN	↓ mm	ltr.	cm	€
82004	1/1	65	8,5	53 x 32,5	17,50
82006	1/1	100	13,0	53 x 32,5	20,00
82008	1/1	150	19,5	53 x 32,5	25,40
82010	1/1	200	26,0	53 x 32,5	33,20
	GN	↓ mm	ltr.	cm	€
82012	1/2	65	3,9	32,5 x 26,5	8,60
82014	1/2	100	5,9	32,5 x 26,5	10,40
82016	1/2	150	8,9	32,5 x 26,5	12,80
82017	1/2	200	11,8	32,5 x 26,5	17,10
	GN	↓ mm	ltr.	cm	€
82018	1/3	65	2,4	32,5 x 17,6	7,20
82020	1/3	100	3,6	32,5 x 17,6	8,60
82022	1/3	150	5,3	32,5 x 17,6	10,40
82023	1/3	200	7,0	32,5 x 17,6	12,80
	GN	↓ mm	ltr.	cm	€
82028	1/4	65	1,7	26,5 x 16,2	5,60
82030	1/4	100	2,5	26,5 x 16,2	6,70
82032	1/4	150	3,7	26,5 x 16,2	10,60
82034	1/4	200	4,8	26,5 x 16,2	13,10
	GN	↓ mm	ltr.	cm	€
82036	1/6	65	1,0	17,6 x 16,2	4,90
82038	1/6	100	1,5	17,6 x 16,2	5,20
82040	1/6	150	2,2	17,6 x 16,2	6,30
82042	1/6	200	2,8	17,6 x 16,2	9,00
	GN	↓ mm	ltr.	cm	€
82050	1/9	65	0,6	17,6 x 10,2	3,50
82051	1/9	100	1,0	17,6 x 10,2	4,00



GN-Deckel

GN-lid
GN tapa
GN couvercle



	GN	cm	€
82001	1/1	53,0 x 32,5	11,60
82013	1/2	32,5 x 26,5	6,70
82019	1/3	32,5 x 17,6	5,30
82029	1/4	26,5 x 16,2	4,30
82037	1/6	17,6 x 16,2	3,30
82059	1/9	17,6 x 10,8	3,00



GN Abtropfgitter

GN drainer
GN escurridor
GN égouttoir



	für GN	cm	€
82003	1/1	47,3 x 26,8	8,80
82005	1/2	26,8 x 20,8	4,90
82007	1/3	26,8 x 11,8	3,80

NEW

BLACK GN CONTAINER



NEW



82065 GN 1/2 | 100 mm



82069 GN 1/3 | 100 mm



82073 GN 1/4 | 100 mm



82077 GN 1/6 | 100 mm



82081 GN 1/9 | 100 mm

GN-Behälter aus Polycarbonat

GN-container polycarbonate

GN cubetas polycarbonato

GN bacs polycarbonate

schwarz: Skalierung in Liter, robust und formstabil

black: liter scale, solid quality

negro: graduación en litros, alta calidad

noir : graduation en litres, haute-qualité



	GN	↓ mm	ltr.	cm	€
82064	1/2	65	3,9	32,5 x 26,5	9,40
82065	1/2	100	5,9	32,5 x 26,5	11,40
82066	1/2	150	8,9	32,5 x 26,5	14,00
	GN	↓ mm	ltr.	cm	€
82068	1/3	65	2,4	32,5 x 17,6	7,90
82069	1/3	100	3,6	32,5 x 17,6	9,40
82070	1/3	150	5,3	32,5 x 17,6	11,40
	GN	↓ mm	ltr.	cm	€
82072	1/4	65	1,7	26,5 x 16,2	6,10
82073	1/4	100	2,5	26,5 x 16,2	7,30
82074	1/4	150	3,7	26,5 x 16,2	8,60
	GN	↓ mm	ltr.	cm	€
82076	1/6	65	1,0	17,6 x 16,2	5,30
82077	1/6	100	1,5	17,6 x 16,2	5,70
82078	1/6	150	2,2	17,6 x 16,2	6,90
	GN	↓ mm	ltr.	cm	€
82081	1/9	100	1,0	17,6 x 10,8	4,40

passende Deckel, S. 358
suitable lid, page 358stapelbar
stackable

GN-CONTAINERS



Backblech

baking sheet
bandeja pastelera
plaque à pâtisserie



geloht Ø 3 mm, Materialstärke 1,5 mm, Silikon beschichtet, temperaturbeständig bis 240°C
perforated Ø 3 mm, coated with silicon, heat resistant up to 240°C
aluminio con revestimiento de silicona perforada, resistente hasta 240°
aluminium avec revêtement silicone, perforée, température maxi 240°

	GN	cm	€
88285	1/1	53 x 32,5	38,00

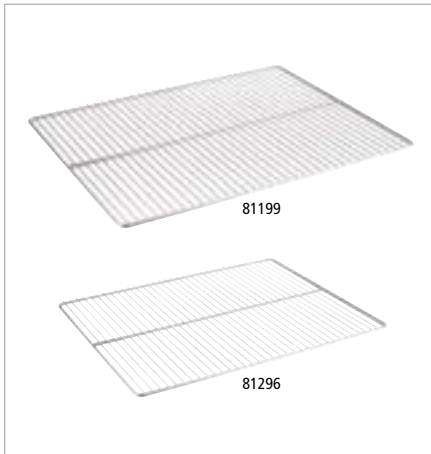

GN Roste

GN grid
GN rejilla
GN grille



elektrolytisch poliert, Drahtstärke 3 mm, Rahmendraht 6 mm, extra schwere Qualität
electro-polished, wire thickness 3 mm, frame wire 6 mm, extra heavy quality
inox pulido electrolítico, grosor alambre 3 mm, grosor marco 6 mm, calidad reforzada
inox poli électrolytique, fil 3 mm, cadre 6 mm, qualité renforcée

	GN	cm	€
81199	2/1	65,0 x 53,0	43,00
81198	1/1	53,0 x 32,5	20,40
81796	2/3	32,5 x 35,4	13,80
81296	1/2	32,5 x 26,5	11,20



GN 1/3 Bestecksammler

GN 1/3 container
GN 1/3 cubeta
GN 1/3 bac



mit 2 Haken zum Einhängen an Servier- oder Transportwagen
container with 2 hooks, to hang on trolleys for cutlery
cubeta con 2 ganchos para cubiertos, a colgar del carro
bac à couverts avec 2 crochets, à accrocher au chariot

	GN	↓ mm	cm	€
11978	1/3	150	32,5 x 17,5	23,00



GN Tablett „FRAMES“

GN tray
GN bandeja
GN plateau



	GN	↑ cm	cm	€
82355	1/1	2	53,0 x 32,5	46,00
82356	1/2	2	32,5 x 26,5	26,00
82357	1/3	2	32,5 x 17,6	22,00



PORCELAIN GN CONTAINERS



GN-Behälter
GN-container
GN cubetas
GN bac



	GN	↓ mm	ltr.	cm	€
82100	1/1	60	7,1	53,0 x 32,5	69,00
82200	1/2	60	3,4	32,5 x 26,5	31,00
82300	1/3	60	2,0	32,5 x 17,6	25,60
82306	2/3	60	4,6	35,4 x 32,5	46,00
82301	2/4	60	3,0	53,0 x 16,2	43,00



GN-Behälter
GN-container
GN cubetas
GN bac



	GN	↓ mm	ltr.	cm	Farbe / colour	€
82270	1/1	60	7,1	53,0 x 32,5		70,00
82271	1/1	60	7,1	53,0 x 32,5		70,00
82272	1/1	60	7,1	53,0 x 32,5		70,00
82273	1/1	60	7,1	53,0 x 32,5		70,00
82274	1/2	60	3,4	32,5 x 26,5		37,00
82275	1/2	60	3,4	32,5 x 26,5		37,00
82276	1/2	60	3,4	32,5 x 26,5		37,00
82277	1/2	60	3,4	32,5 x 26,5		37,00
82278	1/3	60	2,0	32,5 x 17,6		30,00
82279	1/3	60	2,0	32,5 x 17,6		30,00
82280	1/3	60	2,0	32,5 x 17,6		30,00
82281	1/3	60	2,0	32,5 x 17,6		30,00



Präsentationsmöglichkeit
presentation example

GN-CONTAINERS



GN-Behälter „ECOLINE“

GN container

GN cubeta

GN bac

mit Stapelnocke

with notching edge

con borde marcado para el apilado

avec rebord pour l'empilage



	GN	↓ mm	ltr.	cm	Farbe / Colour	€
83759	1/1	65	7,10	53,0 x 32,5		32,60
83755	2/4	65	3,00	53,0 x 16,2		22,00
83757	1/2	65	3,40	32,5 x 26,5		18,60
83753	1/3	65	2,00	32,5 x 17,6		16,00
83751	1/4	65	1,35	26,5 x 16,2		14,20
83749	1/6	65	0,80	17,6 x 16,2		11,20

	GN	↓ mm	ltr.	cm	Farbe / Colour	€
83758	1/1	65	7,10	53,0 x 32,5		32,60
83754	2/4	65	3,00	53,0 x 16,2		22,00
83756	1/2	65	3,40	32,5 x 26,5		18,60
83752	1/3	65	2,00	32,5 x 17,6		16,00
83750	1/4	65	1,35	26,5 x 16,2		14,20
83748	1/6	65	0,80	17,6 x 16,2		11,20

	GN	↓ mm	ltr.	cm	Farbe / Colour	€
84300	1/1	100	10,6	53,0 x 32,5		38,00
84302	2/4	100	4,3	53,0 x 16,2		27,40
84301	1/2	100	4,7	32,5 x 26,5		22,60
84303	1/3	100	2,7	32,5 x 17,6		18,40
84304	1/4	100	1,9	26,5 x 16,2		16,00
84305	1/6	100	1,0	17,6 x 16,2		12,20

	GN	↓ mm	ltr.	cm	Farbe / Colour	€
84306	1/1	100	10,6	53,0 x 32,5		38,00
84308	2/4	100	4,3	53,0 x 16,2		27,40
84307	1/2	100	4,7	32,5 x 26,5		22,60
84309	1/3	100	2,7	32,5 x 17,6		18,40
84310	1/4	100	1,9	26,5 x 16,2		16,00
84311	1/6	100	1,0	17,6 x 16,2		12,20

GN-Deckel

GN-lid

GN tapa

GN couvercle



	GN	cm	€
82001	1/1	53,0 x 32,5	11,60
82013	1/2	32,5 x 26,5	6,70
82019	1/3	32,5 x 17,6	5,30
82029	1/4	26,5 x 16,2	4,30
82037	1/6	17,6 x 16,2	3,30



83762

83763

GN-Behälter „HIGHLINE“

GN-container

GN cubeta

GN bac

mit Stapelnocke

with notching edge

con borde marcado para el apilado

avec rebord pour l'empilage



	GN	↓ mm	ltr.	cm	€
83772	1/1	65	7,10	53,0 x 32,5	41,30
83768	1/2	65	3,40	32,5 x 26,5	22,70
83766	2/4	65	3,00	53,0 x 16,2	26,30
83764	1/3	65	2,00	32,5 x 17,6	17,50
83762	1/4	65	1,35	26,5 x 16,2	16,40
83760	1/6	65	0,80	17,6 x 16,2	12,40

	GN	↓ mm	ltr.	cm	€
83773	1/1	100	11,0	53,0 x 32,5	47,60
83769	1/2	100	5,50	32,5 x 26,5	27,00
83765	1/3	100	3,15	32,5 x 17,6	20,60
83763	1/4	100	2,20	26,5 x 16,2	18,00
83761	1/6	100	1,25	17,6 x 16,2	13,90



83768



83401

83479

Tablett „PURE“

tray

bandeja

plateau



	cm	↑ cm	GN	Farbe / Colour	€
83401	53,0 x 32,5	3	1/1		42,00
83433	53,0 x 16,2	3	2/4		25,00
83480	32,5 x 26,5	3	1/2		22,60
83481	32,5 x 17,6	3	1/3		17,00
83482	26,5 x 16,2	3	1/4		12,40

83597	40,0 x 30,0	3	Bäcker-Maß		32,00
-------	-------------	---	------------	--	-------

	cm	↑ cm	GN	Farbe / Colour	€
83479	53,0 x 32,5	3	1/1		42,00
83434	53,0 x 16,2	3	2/4		24,00
83490	32,5 x 26,5	3	1/2		22,00
83491	32,5 x 17,6	3	1/3		17,00
83492	26,5 x 16,2	3	1/4		12,40

83592	40,0 x 30,0	3	Bäcker-Maß		32,00
-------	-------------	---	------------	--	-------

SERVING TROLLEYS



Servier- / Transportwagen

serving trolley
carro de servicio
chariot de service



Gestell aus Vierkantrohr 25 x 25 mm, Ablagefläche innen 84 x 44,5 cm, Bodenfläche 90 x 50 cm, auf Unterseite schalldämmend beschichtet, Abstand zwischen den Böden 28 cm / 29 cm, mit 4 Lenkrollen Ø 12,5 cm, alle mit Feststellern, Lieferung demontiert, einfache Montage, Tragfähigkeit 33 kg je Boden

frame rectangular bar 25 x 25 mm, shelf board inside 84 x 44,5 cm, shelf board outside 90 x 50 cm, undersurface coated sound-dampening, distance between the boards 28 cm / 29 cm, with 4 swivel wheels Ø 12,5 cm, all with brakes, unassembled, simple assembly, max load 33 kg per shelf

estructura tubo cuadrado 25 x 25 mm, útiles int. por piso 84 x 44,5 cm. ext. al suelo 90 x 50 cm revestimiento para absorber ruidos distancia entre pisos 28 cm / 29 cm, 4 ruedas giratorias 12,50 cm, con frenos, se sirve desmontado, montaje fácil, carga máx. 33 kg por piso

structure en tube carré 25x25 mm, 3 niveaux dimensions utiles 84x44,5 cm, encombrement au sol 90x50 cm, avec revêtement en partie inférieure pour absorber le bruit, distance entre niveaux 28 cm / 29 cm, roues pivotantes 12,5 cm, avec frein, livré démonté, montage aisé, max. 33 kg de charge par niveau

	cm	↑ cm	€
71440	96 x 50	94	184,00



Servier- / Transportwagen

service trolley
carro de servicio
chariot de service



mit 3 Borden, Bordmaße ca. 83 x 51 cm, Abstand zwischen den Borden ca. 26 cm, Tragfähigkeit 120 kg, 4 Lenkrollen, davon 2 feststellbar, Lieferung demontiert, einfache Montage

with 3 trays, trays approx. 83 x 51 cm, size between the trays approx. 26 cm, total load capacity 120 kg, 4 wheels with 2 brakes, unassembled, simple assembly

con 3 bandejas inox mate, aprox. 83 x 51 cm, la medida entre bandejas aprox. 26 cm capacidad total 120 kg, 4 ruedas con 2 frenos, construcción robusta, montaje fácil

3 niveaux, approx. 83x51 cm chacun, distance entre niveaux 26 cm, capacité maxi 120 kg au total, 4 roues dont 2 avec frein, construction robuste, montage facile

	cm	↑ cm	€
11979	91 x 59	93	170,00



Servier- / Transportwagen

service trolley
carro de servicio
chariot de service



mit 2 Borden, Bordmaße ca. 83 x 51 cm, Abstand zwischen den Borden ca. 56 cm, Tragfähigkeit 80 kg, 4 Lenkrollen, davon 2 feststellbar, Lieferung demontiert, einfache Montage

with 2 trays, trays approx. 83 x 51 cm, size between the trays approx. 56 cm, total load capacity 80 kg, 4 wheels with 2 brakes, unassembled, simple assembly

con 2 bandejas de acero inoxidable mate, aprox. 83 x 51 cm, la medida entre bandejas aprox. 56 cm, capacidad total 80 kg, 4 ruedas, con 2 frenos, construcción robusta, montaje fácil

2 niveaux, approx. 83x51 cm chacun, distance entre niveaux 56 cm, capacité maxi 80 kg au total, 4 roues dont 2 avec frein, construction robuste, montage facile

	cm	↑ cm	€
11977	91 x 59	93	150,00

**Servier- / Transportwagen**

serving trolley
carro de servicio
chariot de service



Aluminiumrahmen, 3 Böden, Abstand zwischen den Böden 31 cm, mit 4 Lenkrollen, alle mit Feststellern, Tragfähigkeit: ca. 50 kg je Boden, 150 kg insgesamt, demontiert, einfache Montage, Lieferung ohne Container und Dekoration

frame aluminium, 3 shelves, distance between shelves 31 cm, 4 swivel wheels, all equipped with brakes, max. load per shelf 50 kg, 150 kg total, demounted, easy to mount, delivery without containers and decoration

marco aluminio, 3 pisos, distancia entre cada piso 31 cm, 4 ruedas giratorias, las 4 con frenos, carga máxima por bandeja 50 kg, 150 kg en total, se sirve desmontado, fácil de montar (se entrega sin contenedores ni decoración)

chassis aluminium, 3 étages, distance entre niveaux 31 cm, 4 roues pivotantes, toutes avec frein, charge maximum 50 kg par niveau, 150 kg au total, livré démonté, montage facile (livré sans récipients ni décoration)

	cm	↑ cm		€
11945	108 x 50	96	without containers	154,00

Container zum Einhängen, passend zum Servier- / Transportwagen 11945

container to hang up, suitable serving trolley 11945
contenedor para colgar, adaptado para el carro ref. 11945
récipient à suspendre, pour chariot de service 11945

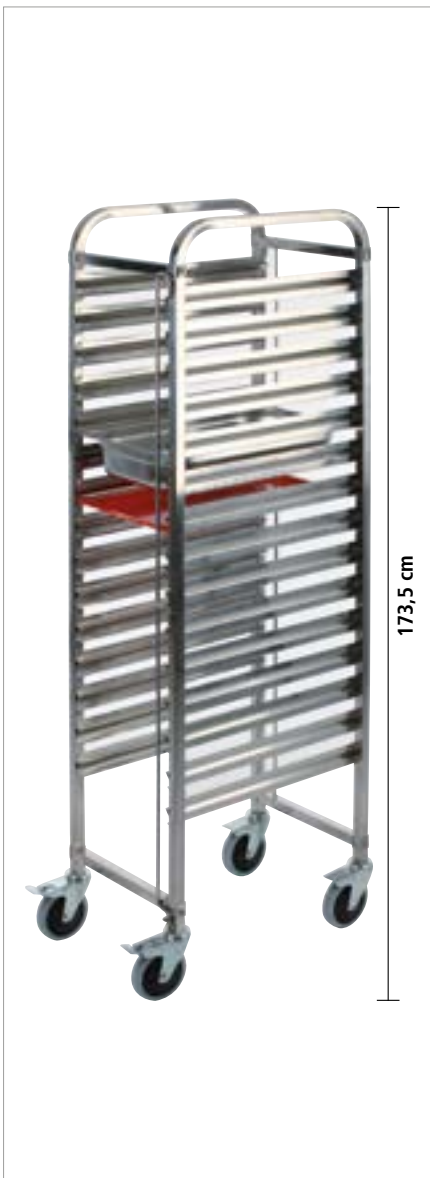

	cm	↑ cm	ltr.	€
11946	33 x 23	56,5	42	35,00
11947	33 x 23	17,5	13	18,00

**GN 1/1 Regalwagen**

GN 1/1 trolley
GN 1/1 carro
GN 1/1 chariot



mit 15 Doppelauflegeschieben, zum Transport von bis zu 30 GN-Tablets GN 1/2 oder 15 GN-Behältern bis GN 1/1 (Längseinschub), bei einem Stapelabstand von 75 mm, mit 4 Lenkrollen, 2 mit Feststellern, Tragfähigkeit 100 kg

15 double bars, for transporting up to 30 trays GN 1/2 or 15 GN containers up to GN 1/1 (lengthwise insertion), size between the trays 75 mm, with 4 swivel wheels, 2 with brakes, max. load 100 kg

15 raíles de soporte dobles, para transportar hasta 30 bandejas GN 1/2 o 15 cubetas GN hasta GN 1/1 (inserción longitudinal), distancia entre las bandejas de 75 mm, con 4 ruedas giratorias, 2 con freno, carga máxima de 100 kg

15 doubles rails de support, pour transporter jusqu'à 30 plateaux GN 1/2 ou 15 bacs GN jusqu'à GN 1/1 (insertion longitudinale), distance entre les plateaux 75 mm, avec 4 roues pivotantes, 2 avec frein, capacité de charge 100 kg

	cm	↑ cm		€
71441	55 x 38,5	173,5		274,00



mit beidseitiger Kipp- und Durchschubsicherung
with tilt and push-through protection on both sides

CUTLERY BOXES



Besteckbehälter

cutlery box
recipiente para cubiertos
réceptif pour couverts

Akazienholz, 4 Fächer (26 x 11,5 cm)

acacia wood, 4 compartments (26 x 11,5 cm)
madera de acacia, 4 compartimentos (26 x 11,5 cm)
bois d'acacia, 4 compartiments (26 x 11,5 cm)



	cm	↑ cm	Farbe / Colour		€
11952	51 x 28	13		nature	48,00
11951	51 x 28	13		vintage white	48,00



Besteckbehälter mit Deckel

cutlery box with cover
caja de cubiertos con tapa
range-couverts avec couvercle

Akazienholz, 4 Fächer (26 x 11,5 cm), mit Deckel

acacia wood, 4 compartments (26 x 11,5 cm), with cover
madera de acacia, 4 compartimentos (26 x 11,5 cm), con tapa
bois d'acacia, 4 compartiments (26 x 11,5 cm), avec couvercle



	cm	↑ cm	Farbe / Colour		€
11949	51 x 28	14,5		nature	74,00
11948	51 x 28	14,5		vintage white	74,00



GN 1/1 Besteckbehälter

GN 1/1 dispenser GN
GN 1/1 dispensador de cubiertos
GN 1/1 bac à couverts

in Handarbeit geflochten, 4 Mulden, Kunststoff-Geflecht, Drahtgestell, braun-schwarz

hand-woven, 4 troughs, plastic wickerwork, wire frame, brown-black
cesta trensada a mano, 4 compartimentos, mimbre de plástico, marco de alambre, marrón-negro
corbeille tressée à main, 4 compartiments, plastique tressé, armature en fil métallique, brun-noir



	cm	↑ cm	Farbe / Colour		GN	€
11966	53 x 32,5	9			1/1	41,00



GN 1/1 Besteckbehälter

GN 1/1 cutlery dispenser
GN 1/1 dispensador de cubiertos
GN 1/1 bac à couverts

4 Mulden, Kunststoff-Geflecht, Drahtgestell, beige

4 troughs, plastic wickerwork, wire frame, beige
4 compartimentos, mimbre de plástico, marco de alambre, beige
4 compartiments, plastique tressé, structure métallique, beige



	cm	↑ cm	Farbe / Colour		GN	€
11965	53 x 32,5	10			1/1	27,40



GN 1/1 Besteckbehälter

GN 1/1 cutlery bin
GN 1/1 recipiente para cubiertos
GN 1/1 récipients pour couverts



4 Mulden

4 troughs
4 compartimentos
4 compartments

	cm	↑ cm	Farbe / Colour	GN	€
11954	53 x 32,5	10	■	1/1	7,80
11955	53 x 32,5	10	■	1/1	7,80

3 Mulden, 3 Köcher

3 troughs, 3 cutlery baskets
3 compartimentos, 3 cestas para cubiertos
3 compartments, 3 corbeilles à couverts

	cm	↑ cm	Farbe / Colour	GN	€
11960	53 x 32,5	10	■	1/1	7,80



Besteckbehälter

cutlery basket
recipiente para cubiertos
récipients pour couverts



4 Löcher inklusive 4 Edelstahl Köcher

4 holes including 4 stainless baskets
4 agujeros con 4 cestas de acero inoxidable
4 trous avec 4 corbeilles en acier inox

	cm	↑ cm	Farbe / Colour	€
93321	27 x 27	15	■	79,00



Besteckköcher

cutlery basket
cesta para cubiertos
corbeille à couverts



Polyethylen weiß / polyethylene white plastic / polietileno blanco / polyéthylène blanc

	Ø cm	↑ cm	€
11998	9,5	13,5	2,90

Edelstahl matt poliert / stainless steel matt polished / acero inoxidable pulido mate / acier inox poli mat

	Ø cm	↑ cm	€
11999	9,5	13,5	8,60



Besteckkasten „INDUSTRIAL“

cutlery box
caja para cubiertos
boîte pour couverts



schwarz, mit Beschriftungsfach 6,5 x 2,5 cm

black, with labelling compartment 6,5 x 2,5 cm
negro, con compartimento de etiquetado 6,5 x 2,5 cm
noir, avec compartiment pour l'étiquetage 6,5 x 2,5 cm

	cm	↑ cm	ltr.	€
40676	23,0 x 15,5	13,0	2,4	15,20



Teig- und Pizzaballenbehälter
 dough and pizza ball container
 recipiente para masa y bolas de pizza
 récipient à pâte et boules à pizza



Innenmaß 56,5 x 36,5 cm, H: 6,5 cm
 inner dimension 56,5 x 36,5 cm, H: 6,5 cm
 medida interior 56,5 x 36,5 cm, H: 6,5 cm
 dimension intérieure 56,5 x 36,5 cm, H: 6,5 cm

	cm	↑ cm	ltr.	€
82440	60 x 40	7	13	12,00



stapelbar
 stackable

passender Deckel / fitting lid / tapa adecuada / couvercle approprié

	cm	↑ cm		€
82441	60 x 40	1		10,00



Eier-Box
 eggs box
 caja para huevos
 boîte à oeufs



mit luftdichtem Deckel, für 4 Lagen à 30 Eier, Lieferung inkl. 8 Lagen, Größe Lage: 28 x 28 cm
 with airtight cover, capacity: 4 trays of 30 eggs, delivery with 8 trays, size of tray: 28 x 28 cm
 capacidad para 4 bandejas de 30 huevos, tapa hermética, se entrega con 8 bandejas, formato bandejas 28 x 28 cm, apto para lavavajillas
 pour 4 plateaux de 30 oeufs chacun, apte pour 4 plateaux plats, couvercle hermétique, livré avec 8 plateaux, dimension plateau 28x28 cm, lavable en lave-vaisselle

	cm	↑ cm	GN	€
82419	35,4 x 32,5	20	2/3	39,90

10 Lagen / 10 trays / 10 bandejas / 10 plateaux

82420				26,00
-------	--	--	--	-------



Wanne
 container
 cubeta
 bac



	cm	↑ cm	ltr.	€
11940	61 x 44	15	25	25,40



Wanne
 container
 cubeta
 bac



	cm	↑ cm	ltr.	€
11950	55 x 42	14	20	12,40



30075 10,5 ltr.



30078 17 ltr.

Profi-Eimer

bucket
cubo
seau



mit Ausgießer und geprägter Maßskalierung innen
with spout and embossed dimension scaling inside
con pico y escala de medición en relieve en el interior
avec bec verseur et échelle de mesure en relief à l'intérieur

	Ø cm	↑ cm	ltr.	Farbe / Colour	€
30075	28,5	28,5	10,5		13,20
30076	33,0	32,0	17,0		17,00
30077	28,5	28,5	10,5		13,20
30078	33,0	32,0	17,0		17,00



mit Griff
with handle



Maßskalierung innen
dimension scaling inside



Auslaufnase für sicheres Handling
discharge nose for safe handling



30065 Ø 6 cm



30068 Ø 12 cm



30070 Ø 17 cm
inkl. Sieb
incl. strainer

Trichter „PROFI“

funnel
embudo
entonnoir



mit Öse
with eyelet
con ojal
avec œillet

	Ø cm	Ø mm Durchlass		€
30065	6	8		1,10
30066	8	11		1,30
30067	10	12		1,50
30068	12	12		2,20
30069	14	15		4,40
30070	17	17	mit Sieb / incl. strainer	6,20
30071	21	20	mit Sieb / incl. strainer	7,60



erleichtert das Einfüllen
facilitates filling



Anwendungsmöglichkeit
applicability



mit einsetzbarem Sieb
incl. insertable strainer





Bar, Café Drinkware

BOTTLE COOLERS.....	372
BEVERAGE DISPENSERS.....	383
DRINKING CUPS.....	385
MOSCOW MULE.....	388
COOL MUGS.....	391
PINEAPPLE MUGS.....	392
JULEP MUGS.....	393
MINI FIRE PUNCH BOWL SETS.....	394
SHAKERS.....	395
JIGGERS.....	397
BAR SPOONS.....	399
BAR STRAINERS.....	400
MUDDLERS.....	402
LEMON SQUEEZERS.....	403
ICE CUBE MAKERS.....	404
ICE BUCKETS.....	405
TONGS.....	407
STRAWS.....	408
DRIP MATS.....	409
CONFERENCE BOTTLE COOLER.....	410
POURERS.....	411
CORKSKREWS BARBLADES.....	413
BARISTA.....	414
TEAPOTS.....	419
TRAYS.....	420
FAST FOOD TRAYS.....	425
BILL PRESENTERS CRUMBERS.....	426
ASHTRAYS.....	427
BINS.....	431
TO GO.....	432

BOTTLE COOLERS



Flaschenkühler „MOSCOW MULE“

bottle cooler
enfriador de botellas
rafraîchisseur de bouteilles

Edelstahl-Flaschenkühler, Antik-Kupfer-Look

stainless steel cooler, copper antique look
enfriador de acero inoxidable, cobre estilo antiguo
rafraîchisseur en acier inox, cuivre style antique



	Ø cm	↑ cm	ltr.		€
93330	20	21	5	copper-antique-hammered	54,00



Wein- / Sektkühler

wine / champagne bowl
cubitera para vino y cava
seau à vin ou champagne

schwarz matt, mit 2 Griffen, extra stabiler eingerollter Rand

black matt, with 2 handles, rolled edge
negro mate, con 2 asas, borde redondeado
noir mat, avec 2 poignées, bord arrondi



	Ø cm	↑ cm	ltr.		€
36115	21,5 / 15	22	5		40,00



Wein- / Sektkühler

wine / champagne bowl
cubitera para vino y cava
seau à vin ou champagne

innen matt poliert, außen hochglanzpoliert, mit massiven Knopf-Griffen, extra stabiler eingerollter Rand, schwere Ausführung

outside mirror polished, inside matt polished, with solid knob handles, rolled edge, heavy quality
exterior pulido brillante, interior pulido mate, asas de botón robustas, borde redondeado, alta calidad

extérieur poli brillant, intérieur poli mat, 2 poignées robuste en forme de bouton, bord arrondi, haute qualité



	Ø cm	↑ cm	ltr.		€
36028	21,5 / 16	22	4		34,00



Wein- / Sektkühler „HAMMERSCHLAG“

wine / champagne bowl
cubitera para vino y cava
seau à vin ou champagne

hochglanzpoliert, mit massiven Ring-Griffen, eingerollter Rand

mirror polished, with solid ring handles, rolled edge, hammered
pulido brillante, con 2 anillos macizos, borde redondeado, repujado
brillant, 2 anneaux massifs, bord arrondi, surface martelée



	Ø cm	↑ cm	ltr.		€
36026	21 / 17	21,5	4		19,00



Wein- / Sektkühler

wine / champagne bowl
cubitera para vino y cava
seau à vin ou champagne

innen matt poliert, außen hochglanzpoliert, mit massiven Griffen, Rand eingerollt

outside mirror polished, inside matt polished, with massive handles, rolled edge
exterior pulido brillante, interior pulido mate, 2 asas macizas, borde redondeado
extérieur poli brillant, intérieur poli mat, 2 anses massives, bord rond



	Ø cm	↑ cm	ltr.		€
36025	21 / 15	21	3,5		18,00



Wein- / Sektkühler
 wine / champagne bowl
 cubitera para vino y cava
 seau à vin ou champagne
matt poliert, Hohlgriffe
 matt polished, hollow handles
 pulido mate, con asas huecas
 poli mat, 2 boutons creux



	Ø cm	↑ cm	ltr.	€
36021	20 / 15	20,5	4	16,00



Wein- / Sektkühler
 wine / champagne bowl
 cubitera para vino y cava
 seau à vin ou champagne
aussen hochglanzpoliert, innen matt poliert, mit Ring-Griffen
 outside mirror polished, inside matt polished, with ring handles
 exterior pulido brillante, interior pulido mate, con 2 asas anillos
 extérieur poli brillant, intérieur poli mat, avec 2 anneaux



	Ø cm	↑ cm	ltr.	€
36020	20 / 15	19	3	14,80



Wein- / Sektkühler
 wine / champagne bowl
 cubitera para vino y cava
 seau à vin ou champagne
glasklarer Rand, transparent gefrostet
 edge transparent, body transparent frosted
 borde transparente, cuerpo transparente efecto glaseado
 bord transparent, corps poli mat



	Ø cm	↑ cm	ltr.	€
36066	22 / 14	23	4	9,80



Wein- / Sektkühler
 wine / champagne bowl
 cubitera para vino y cava
 seau à vin ou champagne
glasklar, mit Tragegriff
 transparent, handle on the side
 transparente, con un asa en el lateral
 transparent, avec poignée



	cm	↑ cm	ltr.	€
36055	23 x 22	27,5	3	23,00



Mini-Eiseimer / Mini-Sektkühler
 ice bucket
 cubitera clásica
 seau à glaçons classique



	Ø cm	↑ cm	ltr.	€
36003	10,5	10	0,5	8,60
36004	13,0	13	1,0	11,00

BOTTLE COOLERS



Ständer für Wein- / Sektkühler

stand for wine / champagne bowl
pie porta champañera / vino
ped pour seau à champagne / vin



hochglanzpoliert, schwerer standsicherer Fuß, Innendurchmesser der Schale Ø 17,5 cm
mirror polished, heavy foot, inner bowl Ø 17,5 cm
acabado pulido efecto brillante, bol interior de Ø 17,5 cm
brillant, intérieur support Ø 17,5 cm

	Ø cm	↑ cm	€
36069	17,5 / 26,5	73	118,00



Wein- / Sektkühler no. 36028

wine / champagne bowl no. 36028
cubitera para vino y cava no. 36028
seau à vin ou champagne no. 36028



Ständer für Wein- / Sektkühler

stand for wine / champagne bowl
pie porta champañera / vino
ped pour seau à champagne / vin



hochglanzpoliert, schwerer standsicherer Fuß, Innendurchmesser der Schale Ø 15 cm
mirror polished, heavy foot, inner bowl Ø 15 cm
acabado pulido efecto brillante, bol interior de Ø 15 cm
brillant, intérieur support Ø 15 cm

	Ø cm	↑ cm	€
36068	15 / 28	68	90,00



Ständer für Wein- / Sektkühler

stand for wine / champagne bowl
pie porta champañera / vino
ped pour seau à champagne / vin



schwarz matt, schwerer standsicherer Fuß, Innendurchmesser der Schale Ø 15 cm
black matt, heavy stable foot, inner bowl Ø 15 cm
negro mate, pie pesado y estable, bol interior de Ø 15 cm
noir mat, pied lourd et stable, intérieur support Ø 15 cm

	Ø cm	↑ cm	€
36116	19,5 / 26,5	71,5	94,00

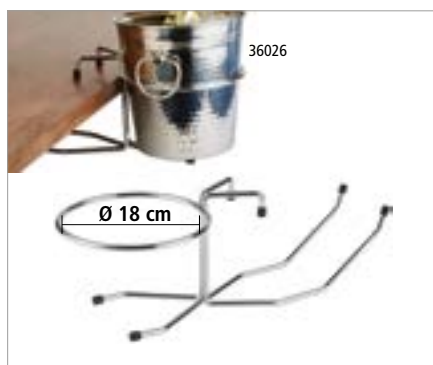
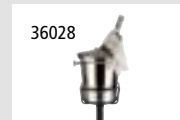

Tischhalterung für Sektkühler

champagne bucket table holder
soporte champañera universal
porte-seau à champagne



aus 8 mm starkem Stahldraht, passen zu allen lieferbaren Sektkühlern, innen Ø-Ring: 18 cm
8 mm chrome plated wire, suitable for all available champagne buckets, inner ring Ø 18 cm
alambre cromado 8 mm, para todas las champañeras, anillo interior Ø 18 cm
fil chromé 8 mm, pour tous les seaux à champagne, anneau intérieur Ø 18 cm

	cm	↑ cm	€
30332	49 x 20	17	18,00



Flaschenkühler

bottle cooler
enfriador de botella
rafraîchisseur de bouteille

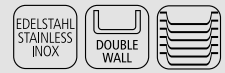

doppelwandig für beste Isolierung, außen Hammerschlag-Optik

double-walled for best insulation, outside: hammered surface
doble pared para un mejor aislamiento, exterior: aspecto martillado
double paroi pour une meilleur isolation, extérieur: surface martelée

	Ø cm	↑ cm	ltr.	Farbe / Colour	€
36120	33	20	8	stainless	68,00
36121	33	20	8	copper-look	68,00



Präsentationsmöglichkeit
presentation examples



Wein- / Sektkühler „XL“

wine / champagne bowl
cubitera para vino y cava
seau à vin ou champagne



gehämmerte Oberfläche, mit 2 seitlichen Eingriffen

hammered surface, with 2 handles on the side
superficie martillada, con 2 asas
surface martelée, avec 2 poignées

	cm	↑ cm	ltr.	Farbe / Colour	€
36111	30 x 23,5	23	7	copper-look	62,00
36112	30 x 23,5	23	7	gunmetal-look	62,00



Wein- / Sektkühler „LARGE“

wine / champagne bowl
cubitera para vino y cava
seau à vin ou champagne



gehämmerte Oberfläche, mit 2 seitlichen Eingriffen, für 1-2 Flasche

hammered surface, with 2 handles on the side, for 1-2 bottle
superficie martillada, con 2 asas, para 1-2 botellas
surface martelée, avec 2 poignées, pour 1-2 bouteilles

	cm	↑ cm	ltr.	Farbe / Colour	€
36108	25,5 x 19	20	3,9	copper-look	32,00
36109	25,5 x 19	20	3,9	gunmetal-look	32,00



Wein- / Sektkühler „SMALL“

wine / champagne bowl
cubitera para vino y cava
seau à vin ou champagne



gehämmerte Oberfläche, für 1 Flasche

hammered surface, for 1 bottle
superficie martillada, para 1 botella
surface martelée, pour 1 bouteille

	cm	↑ cm	ltr.	Farbe / Colour	€
36106	20,5 x 14	17	2,1	copper-look	24,00
36107	20,5 x 14	17	2,1	gunmetal-look	24,00

BOTTLE COOLERS



Flaschenkühler „BRIDGE“

bottle cooler
enfriador de botellas
rafraîchisseur de bouteilles



doppelwandig für beste Isolierung, außen hochglanzpoliert, innen matt poliert

double wall cooler keeps the temp. for a long time, outs. mirror polished, inside matt polished
champañera inox de doble pared, interior pulido mate, exterior pulido brillante
seau inox double paroi, maintient le froid plus longt., intérieur poli mat, extérieur poli brillant

	Ø cm	↑ cm	ltr.	€
36077	31	19	10	106,00



Champagnerkühler

champagne bowl
cubo champañera
seau à champagne



hochglanzpoliert, doppelwandig für beste Isolierung

mirror polished, double wall cooler keeps the temp. for a long time
pulido brillante con champañera inox de doble pared
poli brillant, double paroi, maintient le froid plus longtemps

	Ø cm	↑ cm	ltr.	€
36044	44 / 25	24	10,5	106,00



Champagnerkühler

champagne bowl
cubo champañera
seau à champagne



außen hochglanzpoliert, innen matt poliert, mit vergoldeten Griffen

outside mirror polished, inside matt polished, with gold plated handles
exterior pulido brillante, interior pulido mate
extérieur brillant, intérieur poli mat

	Ø cm	↑ cm	ltr.	€
36047	42 / 27	28	20	99,00



Champagnerkühler

champagne bowl
cubo champañera
seau à champagne



hochglanzpoliert

mirror polished
pulido brillante
poli brillant

	Ø cm	↑ cm	ltr.	€
36045	40,5 / 27,5	22,5	13,5	60,00



Champagnerkühler

champagne bowl
cubo champañera
seau à champagne



hochglanzpoliert, Rand matt poliert

mirror polished, edge matt polished
pulido brillante, borde pulido mate
poli brillant, bord poli mat

	Ø cm	↑ cm	ltr.	€
36046	45 / 21	23	12	52,00

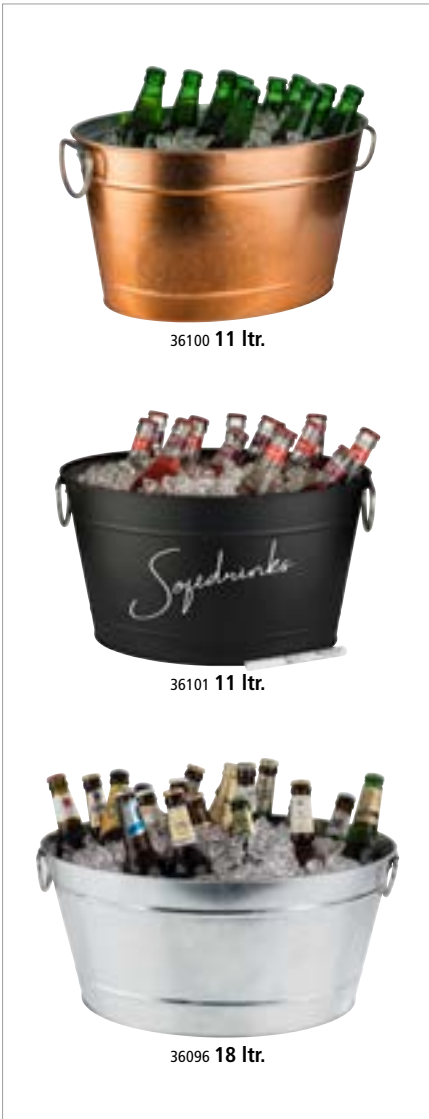

Getränkewanne „TIN“

beverage tub
barreño botellines
bassine à glace

Metall verzinkt, mit Kunststoffeinsatz
galvanised metal, with plastic insert
metal galvanizado, con inserto de plástico
métal galvanisé, avec insert en plastique



	cm	↑ cm	ltr.	Farbe / Colour	€
36100	40 x 28	22	11	copper-look	36,00
36101	40 x 28	22	11	black-metal-look	31,00
36095	40 x 28	22	11	metal-look	30,00
36096	50 x 23	23	18	metal-look	36,00



mit Kunststoffeinsatz
with plastic insert
con inserto de plástico
avec insert en plastique



71490

Kreidestift zum
Beschriften | chalk
marker for writing
S. 304



Wein- / Sektkühler

wine / champagne bowl
cubitera para vino y cava
seau à vin ou champagne

glasklar, für bis zu 6 Flaschen geeignet
transparent, suitable for up to 6 bottles
transparente, para máximo 6 botellas
transparent, maxi 6 bouteilles



	cm	↑ cm	ltr.	€
36057	47 x 28	23	10	41,00



Wein- / Sektkühler

wine / champagne bowl
cubitera para vino y cava
seau à vin ou champagne

mit seitlichen Griffen, transparent
with lateral handles, transparent
con asas laterales
avec poignées latérales



	cm	↑ cm	ltr.	€
36087	32 x 21,5	24,5	7	31,00

BOTTLE COOLERS



36048

Wein- / Sektkühler
 wine / champagne bowl
 cubitera para vino y cava
 seau à vin ou champagne
mit 2 seitlichen Eingriffen
 with 2 handles on the side
 con 2 asas
 avec 2 poignées



	cm	↑ cm	ltr.	€
36048	35 x 27	25,5	6	32,00
36052	27 x 20	21	3	18,00



36054

Wein- / Sektkühler
 wine / champagne bowl
 cubitera para vino y cava
 seau à vin ou champagne
mit 2 seitlichen Eingriffen
 with 2 handles on the side
 con 2 asas
 avec 2 poignées



	cm	↑ cm	ltr.	Farbe / Colour	€
36054	35 x 27	25,5	6	■	38,00
36053	27 x 20	21,0	3	■	23,00



Wein- / Sektkühler
 wine / champagne bowl
 cubitera para vino y cava
 seau à vin ou champagne
glasklar, für zwei Flaschen
 clear, for two bottles
 transparente, para 2 botellas
 transparent, pour 2 bouteilles



	cm	↑ cm	ltr.	€
36056	30,5 x 21,5	26	4	23,00





Flaschenkühler

bottle cooler
enfriador de botella
rafraîchisseur de bouteille



doppelwandig für beste Isolierung, für 0,7 - 1,5 Liter-Flaschen

double wall cooler keeps the temperature for a long time, for 0,7 - 1,5 ltr. bottles
con doble pared para mantener el frio largo tiempo, para botellas de 0,7 - 1,5 ltr.
double paroi pour une meilleure conservation de la température, pour bouteilles de 0,7 à 1,5 l.

	Ø cm	↑ cm	Farbe / Colour	€
36125	12 / 10	20	copper red	23,00
36126	12 / 10	20	blue	23,00
36127	12 / 10	20	black	23,00



Flaschenkühler „COPPER“

bottle cooler
enfriador de botella
rafraîchisseur de bouteille



Hammerschlag-Optik, doppelwandig für beste Isolierung, für 0,7 - 1,5 Liter-Flaschen

double wall cooler keeps the temperature for a long time, hammered look, for 0,7 - 1,5 ltr. bottles
doble pared para mantener el frigo largo tiempo, para botellas de 0,7 - 1,5 ltr.
double paroi pour une meilleure conservation de la température, pour bouteilles de 0,7 à 1,5 l.

	Ø cm	↑ cm	Farbe / Colour	€
36074	12 / 10	20		26,00



Flaschenkühler

bottle cooler
enfriador de botella
rafraîchisseur de bouteille

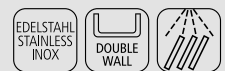

matt poliert, doppelwandig für beste Isolierung, für 0,7 - 1,5 Liter-Flaschen

matt polished, double wall cooler keeps the temperature for a long time, for 0,7 - 1,5 ltr. bottles
pulido mate, doble pared para mantener el frio largo tiempo, para botellas de 0,7 - 1,5 ltr.
poli mat, double paroi pour une meilleure conservation de la température, pour bouteilles de 0,7 à 1,5 l.

	Ø cm	↑ cm	€
36030	12 / 10	20	18,00



Flaschenkühler

bottle cooler
enfriador de botella
rafraîchisseur de bouteille



matt poliert, doppelwandig für beste Isolierung, für 0,7 - 1,5 Liter-Flaschen

matt polished, double wall cooler keeps the temperature for a long time, for 0,7 - 1,5 ltr. bottles
pulido mate con doble pared para mantener el frio largo tiempo, para botellas de 0,7 - 1,5 ltr.
poli mat, double paroi pour une meilleure conservation de la température, pour bouteilles de 0,7 à 1,5 l.

	Ø cm	↑ cm	€
36038	12,5 / 10	19	23,00

BOTTLE COOLERS



Flaschenkühler

bottle cooler
enfriador de botella
rafraîchisseur de bouteille



transparent, doppelwandig für beste Isolierung, mit Chromrand

transparent, double wall cooler keeps the temperature for a long time, with chrome edge
transpar., doble pared mantiene la temperatura por largo tiempo, borde superior cromado
transparent, bord chromé brillant, double paroi pour maintien en température

	Ø cm	↑ cm	Farbe / Colour	€
36032	12 / 10	23		10,00
36034	12 / 10	23		10,00



Flaschenkühler „PURE“

bottle cooler
enfriador de botella
rafraîchisseur de bouteille



doppelwandig für beste Isolierung, glasklar

double wall cooler keeps the temperature for a long time, clear
doble pared mantiene la temperatura por largo tiempo, transparente
double paroi pour maintien en température, transparent

	Ø cm	↑ cm	€
36063	13,5 / 10,5	23	9,00
36062	13,5 / 10,5	23	9,00



Pitcher

pitcher
jarra
pichet



	Ø cm	↑ cm	ltr.	€
93105	13	21	1,5	10,40



einfaches Eingießen
easy pouring

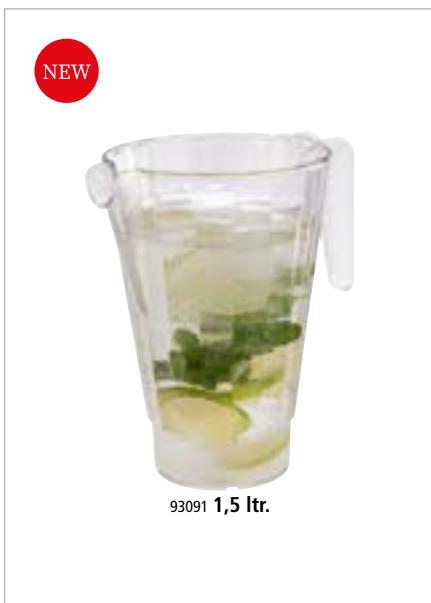

NEW

93091 1,5 ltr.

Pitcher

pitcher
jarra
pichet



	Ø cm	↑ cm	ltr.	€
93090	12,5	17,5	1,0	9,00
93091	13,5	20,0	1,5	10,00

passende Deckel / fitting lids / tapa adecuadas / couvercles appropriées

	cm	↑ cm	fits to	€
93092	13,0	1,5	93090	2,00
93093	14,0	1,5	93091	2,00

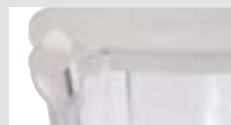

Deckel mit Klappe
lid with flap



einfaches Eingießen
easy pouring



stapelbar
stackable



Flaschenkühler „ELEMENT“

bottle cooler
enfriador de botella
rafraîchisseur de bouteille

Beton, geriffelte Oberfläche, möbelschonende Unterseite
concrete, ribbed surface, non-scratching undersurface
hormigón, superficie ranurada, base anti rayaduras
béton, surface rainurée, base revêtement antirayures



	Ø cm	↑ cm	Farbe / Colour	€
36122	13 / 10	19,5	white	20,00
36123	13 / 10	19,5	concrete	20,00
36124	13 / 10	19,5	green	20,00



Oberflächenansicht
structural view



Präsentationsmöglichkeit
presentation example



Flaschenkühler „ELEMENT“

bottle cooler
enfriador de botella
rafraîchisseur de bouteille

Beton, möbelschonende Unterseite
concrete, non-scratching undersurface
hormigón, base anti rayaduras
béton, base revêtement antirayures



	Ø cm	↑ cm	Farbe / Colour	€
36104	12 / 10	19	rose	20,00
36105	12 / 10	19	green	20,00



Flaschenkühler „ELEMENT“

bottle cooler
enfriador de botella
rafraîchisseur de bouteille

Beton, möbelschonende Unterseite
concrete, non-scratching undersurface
hormigón, base anti rayaduras
béton, base revêtement antirayures



	Ø cm	↑ cm	Farbe / Colour	€
36090	12 / 10	19	concrete	20,00
36099	12 / 10	19	black	20,00

BOTTLE COOLERS

NEW



Flaschenkühler „BIG BOWL“

bottle cooler
enfriador de botella
rafraîchisseur de bouteille



gehämmerte Oberfläche, innen matt poliert, herausnehmbarer Tropfeinsatz

hammered surface, inside matt polished, removable drip tray
superficie martillada, interior pulido mate, bandeja de goteo extraíble
surface martelée, intérieur poli mat, bac de récupération amovible

	Ø cm	↑ cm	ltr.	€
36130	37	23	8	240,00



herausnehmbarer
Tropfeinsatz
removable drip tray



Präsentationsmöglichkeit
presentation example



Kühlmanschette „CHAMPAGNE“

cool collar
funda de frío
housse isotherme



für Sekt- / Champagnerflaschen, einfach im Gefrierfach einfrieren, komplette Flasche wird in 5 Min. auf angenehme Trinktemperatur gekühlt, außen reißfestes Stoffgewebe, innen Kunststoff mit Kühlgel gefüllt, unbegrenzt wiederverwendbar

for bottles of champagne, simply to freeze in the freezer, complete bottles will be cooled down in only 5 minutes, tearproof cloth outside, plastic filled with gel inside, unlimited reusable
para botellas de cava o champán simplemente congelándola en el congelador, la botella entera se enfriará en 5 minutos, funda de plástico muy robusta, rellena con un gel congelante reutilizable ilimitadamente

pour bouteilles de vin ou champagne, la housse est préalablement stockée au congélateur, où elle accumule le froid, ensuite elle refroidit une bouteille en quelques minutes, plastique résistant, contient un liquide congelant, à réutiliser de façon illimitée

	Ø cm	↑ cm	€
36075	11	18	6,60



Weinflaschenhalter

winebottle-stand
soporte para botella de vino
porte-bouteille



	cm	↑ cm	€
30333	22 x 6	20,5	9,40

BEVERAGE DISPENSERS



Getränkespender „INDUSTRIAL“

beverage dispenser
dispensador de bebidas
distributeur de boissons

Black
is
beautiful



Behälter aus Glas, Zapfhahn aus Edelstahl, Fuß und Deckel aus Metall, schwarz, Antirutschmatte aus Silikon

glass container, stainless steel tap, base and lid in black metal, silicone non-slip mat
recipiente de vidrio, grifo de acero inoxidable, base y tapa de metal negro, alfombra antideslizante de silicona

réceptien en verre, robinet en acier inox, pied et couvercle en métal noir, tapis antidérapant en silicone

7 ltr.

10853

	Ø cm	↑ cm	ltr.		€
10450	20	45	7	inkl. Gestell / incl. stand	94,00



Antirutschmatte aus Silikon
Antirutschmatte aus Silikon



Getränkespender „URBAN“

beverage dispenser
dispensador de bebidas
distributeur de boissons

Black
is
beautiful



Behälter aus Glas, Zapfhahn aus Edelstahl, Fuß und Deckel aus Metall, schwarz, Antirutschmatte aus Silikon

glass container, stainless steel tap, base and lid in black metal, silicone non-slip mat
recipiente de vidrio, grifo de acero inoxidable, base y tapa de metal negro, alfombra antideslizante de silicona

réceptien en verre, robinet en acier inox, pied et couvercle en métal noir, tapis antidérapant en silicone

7 ltr.

	Ø cm	↑ cm	ltr.		€
10451	22	45	7	inkl. Gestell / incl. stand	94,00



Antirutschmatte aus Silikon
Antirutschmatte aus Silikon



Eiswasserröhre

ice cube cooling tube
tubo enfriador para cubitos
tube pour glaçons



	Ø cm	↑ cm	passend für Getränkenspender / fits to drink dispenser	€
10849	11	24	10400, 10403, 10450, 10451, 10855	8,80

BEVERAGE DISPENSERS



7 ltr.

Getränkespender „ELEMENT“

beverage dispenser
dispensador de bebidas
distributeur de boissons



Behälter aus Glas, Zapfhahn aus Edelstahl, Fuß und Deckel aus Beton

glass container, stainless steel tap, stand and lid made of concrete
recipiente de vidrio, grifo de acero inoxidable, soporte y tapa de hormigón
récipient en verre, robinet en acier inox, support et couvercle en béton

	Ø cm	↑ cm	ltr.		€
10400	22	45	7	inkl. Gestell / incl. stand	114,00



7 ltr.

Getränkespender „OLD FASHIONED“

beverage dispenser
dispensador de bebidas
distributeur de boissons



Behälter aus Glas, Zapfhahn aus Edelstahl, Gestell schwarz

glass container, stainless steel tap, black stand
recipiente de vidrio, grifo de acero inoxidable, soporte negro
récipient en verre, robinet en acier inox, support noir

	Ø cm	↑ cm	ltr.		€
10409	27	50,5	7	inkl. Gestell / incl. stand	82,00

Ersatz-Gestell / stand / soporte de recambio / support de remplacement

	Ø cm	↑ cm		€
10410	27	31,5		15,40

Ersatz-Glas / replacement glass / cristal de recambio / vitre de rechange

	Ø cm	↑ cm	ltr.	€
10411	19	36,5	7	46,00

Ersatz-Zapfhahn 10409 / replacement tap for 10409

	€
10718	26,00



7 ltr.

Getränkespender „ASIA“

beverage dispenser
dispensador de bebidas
distributeur de boissons



Behälter aus Glas, Zapfhahn aus Edelstahl, Fuß und Deckel aus Holz

glass container, stainless steel tap, wooden stand and lid
recipiente de vidrio, grifo de acero inoxidable, soporte y tapa de madera
récipient en verre, robinet en acier inox, support et couvercle en bois

	Ø cm	↑ cm	ltr.		€
10403	24,5	45,5	7	inkl. Gestell / incl. stand	94,00

Ersatz-Fuß / base / soporte de recambio / support de remplacement

	Ø cm	↑ cm		€
10404	24,5	15		25,00

Ersatz-Deckel / replacement lid / tapa de recambio / couvercle de rechange

	Ø cm	↑ cm		€
10405	14,0	5		9,60



10853

Tropfenschale, 2-teilig

drip tray, 2 pcs.
aros anti-goteo, set de 2
anneaux coupe-gouttes, set de 2



	Ø cm	↑ cm	Farbe / Colour	€
10851	9,5	1,5	White	7,40
10853	9,5	1,5	Black	7,40

LINEA



UNZERBRECHLICH | UNBREAKABLE



Trinkbecher „LINEA“

drinking cups

vasos

gobelets



Die elegant facettierte Bechergläser LINEA lassen sich vielseitig im Bar-, Club-, Pool-, und Buffetbereich verwenden. Sowohl die transparenten als auch die farbigen Modelle setzen in jedem Ambiente edle Akzente. Dank ihrer perfekten Stapelbarkeit werden sie platzsparend aufbewahrt und transportiert.

The elegantly faceted tumbler glasses LINEA can be used in a variety of ways in the bar, club, pool and buffet areas. Both the transparent and coloured models set elegant accents in any ambience. Thanks to their perfect stackability, they are space-saving to store and transport.

Los vasos LINEA, elegantemente facetados, pueden utilizarse de diversas maneras en el bar, el club, la piscina y el buffet. Tanto los modelos transparentes como los de color ponen elegantes acentos en cualquier ambiente. Gracias a su perfecta apilabilidad, ahorran espacio para su almacenamiento y transporte.

Les verres LINEA élégamment facetés peuvent être utilisés de manière polyvalente dans les bars, les clubs, les piscines et les buffets. Les modèles transparents et colorés apportent une touche de noblesse dans chaque ambiance. Grâce à leur parfaite empilabilité, ils se rangent et se transportent avec un minimum d'encombrement.

	Ø cm	↑ cm	ltr.	VE	Farbe / Colour	€/ pc.
10560	6,5	8,0	0,15	48	—	2,40
10561	8,5	8,0	0,22	48	—	2,70
10562	8,5	10,0	0,30	48	—	3,20
10563	8,5	12,0	0,40	48	—	3,60
10564	8,5	15,0	0,50	48	—	4,00
10565	6,5	8,0	0,15	48	■ french grey	2,50
10566	8,5	8,0	0,22	48	■ french grey	2,80
10567	8,5	10,0	0,30	48	■ french grey	3,30
10568	8,5	12,0	0,40	48	■ french grey	3,70
10569	8,5	15,0	0,50	48	■ french grey	4,10
10570	6,5	8,0	0,15	48	■ light green	2,50
10571	8,5	8,0	0,22	48	■ light green	2,80
10572	8,5	10,0	0,30	48	■ light green	3,30
10573	8,5	12,0	0,40	48	■ light green	3,70
10574	8,5	15,0	0,50	48	■ light green	4,10
10575	6,5	8,0	0,15	48	■ light pink	2,50
10576	8,5	8,0	0,22	48	■ light pink	2,80
10577	8,5	10,0	0,30	48	■ light pink	3,30
10578	8,5	12,0	0,40	48	■ light pink	3,70
10579	8,5	15,0	0,50	48	■ light pink	4,10
10585	6,5	8,0	0,15	48	■ light blue	2,50
10586	8,5	8,0	0,22	48	■ light blue	2,80
10587	8,5	10,0	0,30	48	■ light blue	3,30
10588	8,5	12,0	0,40	48	■ light blue	3,70
10589	8,5	15,0	0,50	48	■ light blue	4,10



alle Größen
ineinander stapelbar
all sizes stackable

CRYSTAL



UNZERBRECHLICH | UNBREAKABLE

5 SIZES

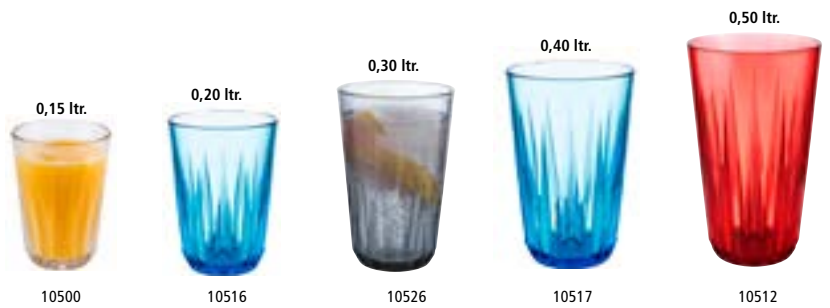

Trinkbecher „CRYSTAL“
drinking cups
vasos
gobelets



Kristallglas-Optik, vielseitig einsetzbar, robustes, unzerbrechliches Material, ideal in sensiblen Bereichen wie Pool, Spa, Beach und Wellness einzusetzen, BPA-frei
crystal-glass-look, can be used in versatile ways, a solide and unbreakable material, ideal to be used at pool, spa, beach and wellness areas, bpa-free
aspecto vidrio, se pueden utilizar de muchas maneras diferentes, material sólido e irrompible, ideal para el uso en áreas como piscina, spa, playa y bienestar, libre de BPA
ressemble à un verre de cristal, peuvent être utilisés de différentes façons, matériau robuste et incassable, idéal pour une utilisation dans des zones comme la piscine, le spa, la plage et le bien-être, sans BPA

	Ø cm	↑ cm	ltr.	VE	Farbe / Colour	€/ pc.
10500	7,0	9,5	0,15	48	—	3,00
10503	7,5	11,0	0,20	48	—	3,40
10501	8,0	12,5	0,30	48	—	4,10
10504	8,5	14,0	0,40	48	—	4,50
10502	9,0	15,5	0,50	48	—	5,10
	Ø cm	↑ cm	ltr.	VE	Farbe / Colour	€/ pc.
10513	7,0	9,5	0,15	48	■	3,10
10516	7,5	11,0	0,20	48	■	3,50
10514	8,0	12,5	0,30	48	■	4,20
10517	8,5	14,0	0,40	48	■	4,60
10515	9,0	15,5	0,50	48	■	5,20



UNZERBRECHLICH
UNBREAKABLE



Made in Germany

Auch die inneren Werte können sich sehen lassen. Der Trinkbecher „CRYSTAL“ wird ressourcenschonend ausschließlich in Deutschland produziert. Das Material ist zu 100% recycelbar.





	Ø cm	↑ cm	ltr.	VE	Farbe / Colour	€/ pc.
10510	7,0	9,5	0,15	48		3,10
10511	8,0	12,5	0,30	48		4,20
10512	9,0	15,5	0,50	48		5,20
	Ø cm	↑ cm	ltr.	VE	Farbe / Colour	€/ pc.
10525	7,0	9,5	0,15	48		3,10
10526	8,0	12,5	0,30	48		4,20
10527	9,0	15,5	0,50	48		5,20
	Ø cm	↑ cm	ltr.	VE	Farbe / Colour	€/ pc.
10528	7,0	9,5	0,15	48		3,10
10529	8,0	12,5	0,30	48		4,20
10530	9,0	15,5	0,50	48		5,20
	Ø cm	↑ cm	ltr.	VE	Farbe / Colour	€/ pc.
10531	7,0	9,5	0,15	48		3,10
10532	8,0	12,5	0,30	48		4,20
10533	9,0	15,5	0,50	48		5,20
	Ø cm	↑ cm	ltr.	VE	Farbe / Colour	€/ pc.
10534	7,0	9,5	0,15	48		3,10
10535	8,0	12,5	0,30	48		4,20
10536	9,0	15,5	0,50	48		5,20

UNZERBRECHLICH
UNBREAKABLE

Farbe grau
colour light grey

10509

stapelbar
stackable

Trinkglas „BEACH“
drinking glass
vaso
verre

vielseitig einsetzbar, robustes, unzerbrechliches Material, BPA-frei
can be used in versatile ways, a solide and unbreakable material, bpa-free
se pueden utilizar de muchas maneras diferentes, material sólido e irrompible, libre de BPA
peuvent être utilisés de différentes façons, matériau robuste et incassable, sans BPA

	Ø cm	↑ cm	ltr.	VE	Farbe / Colour	€/ pc.
10509	8,5	13,5	0,30	48		4,40
10505	8,5	13,5	0,30	48	–	4,20



MOSCOW MULE



Flaschenkühler „MOSCOW MULE“

bottle cooler
enfriador de botellas
rafraîchisseur de bouteilles

Edelstahl-Flaschenkühler, Antik-Kupfer-Look
stainless steel cooler, copper antique look
enfriador de acero inoxidable, cobre estilo antigua
rafraîchisseur en acier inox, cuivre style antique



	Ø cm	↑ cm	ltr.	Farbe / Colour	€
93330	20	21	5	copper-antique-hammered	54,00



Becher „MOSCOW MULE“, 2er-Set

barrel copper mug, 2 pcs.
taza, set de 2
gobelet, set de 2

Edelstahlbecher, Antik-Kupfer-Look
stainless steel cup, copper antique look
taza de acero inoxidable, cobre estilo antiguo
gobelet en acier inox, cuivre style antique



	Ø cm	↑ cm	ltr.	Farbe / Colour	€ / set
93367	9	10	0,5	copper-antique-hammered	23,20



Becher „MOSCOW MULE“

barrel mug
taza
gobelet

Edelstahlbecher, Antik-Edelstahl-Look
stainless steel cup, stainless steel antique look
taza de acero inoxidable, acero estilo antiguo
gobelet en acier inox, acier style antique



	Ø cm	↑ cm	ltr.	Farbe / Colour	€
93346	9	10	0,5	stainless-antique-hammered	11,80

**Becher „MOSCOW MULE“**

barrel mug

taza

gobelet

Edelstahlbecher, Antik-Edelstahl-Look

stainless steel cup, stainless antique look

taza de acero inoxidable, acero estilo antiguo

gobelet en acier inox, acier style antique



	Ø cm	↑ cm	ltr.	Farbe / Colour		€
93345	9	9	0,45		stainless-antique	11,80

**Becher „MOSCOW MULE“**

barrel copper mug

taza

gobelet

Edelstahlbecher, Antik-Kupfer-Look

stainless steel cup, copper antique look

taza de acero inoxidable, cobre estilo antiguo

gobelet en acier inox, cuivre style antique



	Ø cm	↑ cm	ltr.	Farbe / Colour		€
93322	9	9	0,45		copper-antique	11,80

**Becher „MOSCOW MULE“**

barrel copper mug

taza

gobelet

Edelstahlbecher, Kupfer-Look, hochglanzpoliert

stainless steel cup, copper look, mirror polished

taza de acero inoxidable, estilo cobre, pulido brillante

gobelet en acier inox, aspect cuivre, poli brillant

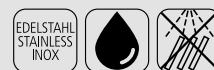

	Ø cm	↑ cm	ltr.	Farbe / Colour		€
93310	9	9	0,45		copper-look	11,80

**Becher „MOSCOW MULE“**

barrel copper mug

taza

gobelet

Edelstahlbecher, Kupfer-Look, hochglanzpoliert

stainless steel cup, copper look, mirror polished

taza de acero inoxidable, estilo cobre, pulido brillante

gobelet en acier inox, aspect cuivre, poli brillant



	Ø cm	↑ cm	ltr.	Farbe / Colour		€
93311	9	10	0,50		copper-hammered	11,80

**Becher „MOSCOW MULE“**

barrel copper mug

taza

gobelet

Edelstahlbecher, Antik-Kupfer-Look

stainless steel cup, copper look

taza de acero inoxidable, cobre estilo antiguo

gobelet en acier inox, cuivre style antique



	Ø cm	↑ cm	ltr.	Farbe / Colour		€
93323	9	10	0,50		copper-antique-hammered	11,80

MOSCOW MULE



Becher „MOSCOW MULE“

barrel mug
taza
gobelet

Edelstahlbecher, Antik-Edelstahl-Look
stainless steel cup, stainless antique look
taza de acero inoxidable, acero estilo antiguo
gobelet en acier inox, acier style antique



	Ø cm	↑ cm	litr.	Farbe / Colour		€
93333	9,5	10	0,50		stainless-antique	11,80



Becher „MOSCOW MULE“

barrel copper mug
taza
gobelet

Edelstahlbecher, Antik-Kupfer-Look
stainless steel cup, copper antique look
taza de acero inoxidable, cobre estilo antiguo
gobelet en acier inox, cuivre style antique



	Ø cm	↑ cm	litr.	Farbe / Colour		€
93331	9,5	10	0,50		copper-antique	11,80



Becher „MOSCOW MULE“

barrel copper mug
taza
gobelet

Edelstahlbecher, Kupfer-Look, hochglanzpoliert
stainless steel cup, copper look, mirror polished
taza de acero inoxidable, estilo cobre, pulido brillante
gobelet en acier inox, aspect cuivre, poli brillant



	Ø cm	↑ cm	litr.	Farbe / Colour		€
93332	9,5	10	0,50		copper-look	11,80

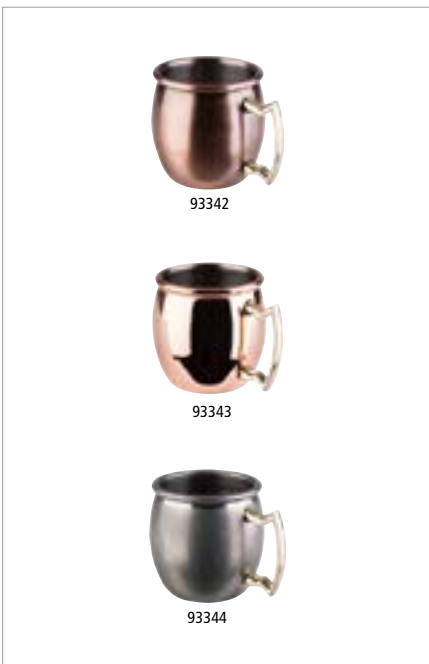

Becher „MINI SHOT“, 4er-Set

barrel mug 4 pcs.
taza, set de 4
gobelet, set de 4



	Ø cm	↑ cm	litr.	Farbe / Colour		pcs.	€ / set
93342	4,5	4,5	0,05		copper-antique	4	20,00
93343	4,5	4,5	0,05		copper-look	4	20,00
93344	4,5	4,5	0,05		stainless-antique	4	20,00





Becher „COOL“

barrel mug
taza
gobelet



Edelstahlbecher, Kupfer-Look, hochglanzpoliert
stainless steel cup, copper look, mirror polished
taza de acero inoxidable, estilo cobre, pulido brillante
gobelet en acier inox, aspect cuivre, poli brillant

	Ø cm	↑ cm	ltr.	Farbe / Colour		€
93371	7,5	10,5	0,35		copper-look	9,90



Becher „COOL“

barrel mug
taza
gobelet



Edelstahlbecher, Gunmetal-Look, hochglanzpoliert
stainless steel cup, gunmetal look, mirror polished
taza de acero inoxidable, estilo gunmetal, pulido brillante
gobelet en acier inox, aspect gunmetal, poli brillant

	Ø cm	↑ cm	ltr.	Farbe / Colour		€
93372	7,5	10,5	0,35		gunmetal-look	9,90



Becher „COOL“

barrel mug
taza
gobelet



Edelstahlbecher, Antik-Edelstahl-Look
stainless steel cup, stainless antique look
taza de acero inoxidable, acero estilo antiguo
gobelet en acier inox, acier style antique

	Ø cm	↑ cm	ltr.	Farbe / Colour		€
93373	7,5	10,5	0,35		stainless-antique	9,90

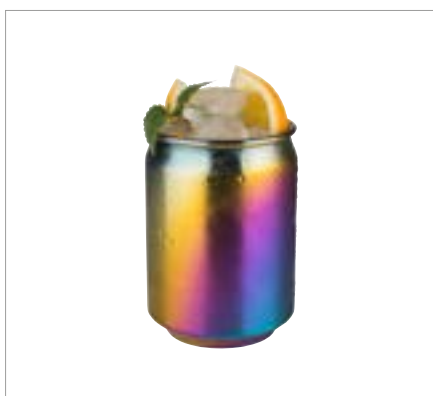

Becher „COOL“

barrel mug
taza
gobelet



Edelstahlbecher, Regenbogen-Look
stainless steel cup, rainbow look
taza de acero inoxidable, estilo arco iris
gobelet en acier inox, look arc-en-ciel

	Ø cm	↑ cm	ltr.	Farbe / Colour		€
93374	7,5	10,5	0,35		rainbow-look	9,90



Becher „BEER MUG“

barrel mug
taza
gobelet



	Ø cm	↑ cm	ltr.	Farbe / Colour		€
93364	8,5	13	0,50		copper-antique	15,40
93365	8,5	13	0,50		stainless-antique	15,40

93364

93365

PINEAPPLE MUGS



Becher „PINEAPPLE“

barrel mug
taza
gobelet

Glasbecher mit Edelstahl Deckel
glass cup with stainless steel lid
taza de cristal con tapa en acero inoxidable
gobelet en verre avec couvercle en acier inox



	Ø cm	↑ cm	ltr.	€
93375	8,5	17,5	0,35	18,50



Becher „PINEAPPLE“

barrel mug
taza
gobelet

Edelstahlbecher, Kupfer-Look
stainless steel cup, copper look
taza de acero inoxidable, cobre
gobelet en acier inox, cuivre



	Ø cm	↑ cm	ltr.	Farbe / Colour	€
93334	9	19	0,5	 copper-look	22,90



Becher „PINEAPPLE“

barrel mug
taza
gobelet

Edelstahlbecher, Gold-Look
stainless steel cup, gold look
taza de acero inoxidable, dorada
gobelet en acier inox, doré



	Ø cm	↑ cm	ltr.	Farbe / Colour	€
93335	9	19	0,5	 gold-look	22,90



Gläserchiene

glass rack
rack de copas
rack porte-verres

aus 6 mm Draht, Metall verchromt, Wand- und Deckenmontage möglich
6 mm chrome plated wire, can be mounted under a shelf or on the wall
alambre cromado de 6 mm, puede instalarse bajo una estantería o en la pared
fil chromé de 6 mm, à installer sous une étagère ou contre un mur



	cm	↑ cm	for glasses	Farbe / Colour	€
93398	29,5 x 32	6	12	 chrome	25,00
93399	29,5 x 32	6	12	 black	25,00
93400	45,0 x 32	6	20	 chrome	34,00

JULEP MUGS



Becher „JULEP MUG“ barrel mug taza gobelet



	Ø cm	↑ cm	ltr.	Farbe / Colour	€
93336	8	11,5	0,40	copper-antique-hammered	12,80
93337	8	11,5	0,40	copper-hammered	12,80
93338	8	11,5	0,40	stainless-antique-hammered	12,80



Becher „JULEP MUG“ barrel mug taza gobelet



	Ø cm	↑ cm	ltr.	Farbe / Colour	€
93327	8,5	10	0,35	copper-antique	12,80
93328	8,5	10	0,35	copper-look	12,80
93329	8,5	10	0,35	stainless	12,80



Snackspender snack dispenser dispensador de snacks distributeur de snacks



Behälter aus Glas, Schraubdeckel aus Edelstahl, Öffnung oval 3,5 x 2,5 cm
glass container, stainless steel screw cap, opening oval 3,5 x 2,5 cm
recipiente de cristal, tapón de rosca de acero inoxidable, apertura ovalada 3,5 x 2,5 cm
récipient en verre, couvercle à visser en acier inox, ouverture ovale 3,5 x 2,5 cm

	Ø cm	↑ cm	ltr.	Farbe / Colour	€
40516	8,5	15,5	0,35	gold-look	8,00
40517	8,5	15,5	0,35	gunmetal-look	8,00



MINI FEUERZANGEN-SETS



Mini Feuerzangen-Set I

mini fire punch bowl set
mini set para ponche caliente
mini set pour punch



bestehend aus: 6 Mini Feuerzangen / 50 Mini Zuckerhüte

consisting of: 6 mini fire tongs / 50 mini sugar cones
compuesto por: 6 mini pinzas para el fuego / 50 mini conos de azúcar
composé de: 6 mini-pinces à feu / 50 mini-cônes à sucre

	cm	↑ cm	€ / set
65070	14,5 x 3,5	1,5	19,00



Mini Feuerzangen-Set II

mini fire punch bowl set
mini set para ponche caliente
mini set pour punch



bestehend aus:

2 Edelstahlbecher, Kupfer-Look / 2 Mini Feuerzangen / 50 Mini Zuckerhüte

consisting of:
2 stainless steel cups, copper look / 2 mini fire tongs / 50 mini sugar cones
compuesto por:
2 tazas de acero inoxidable, cobre / 2 mini pinzas para el fuego / 50 mini conos de azúcar
composé de:
2 tasses en acier inox, cuivre / 2 mini-pinces à feu / 50 mini-cônes à sucre

	∅ cm	↑ cm	litr.	€ / set
65071	9	9	0,45	29,00

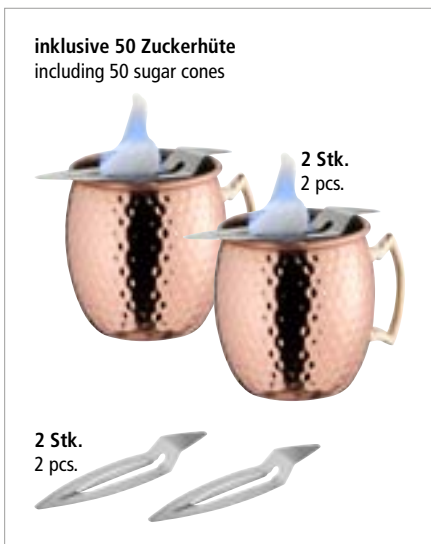

Mini Feuerzangen-Set II

mini fire punch bowl set
mini set para ponche caliente
mini set pour punch



bestehend aus:

2 Edelstahlbecher, Kupfer-Look / 2 Mini Feuerzangen / 50 Mini Zuckerhüte

consisting of:
2 stainless steel cups, copper look / 2 mini fire tongs / 50 mini sugar cones
compuesto por:
2 tazas de acero inoxidable, cobre / 2 mini pinzas para el fuego / 50 mini conos de azúcar
composé de:
2 tasses en acier inox, cuivre / 2 mini-pinces à feu / 50 mini-cônes à sucre

	∅ cm	↑ cm	litr.	€ / set
65072	9	10	0,5	29,00

SHAKERS



Shaker „CLASSIC“

shaker
coctelera
shaker



3-teiliges Set: Edelstahlbecher, Siebaufsatz, Deckel, hochglanzpoliert

3 pieces: stainless steel mug, strainer, lid, mirror polished

set de 3: taza de acero inoxidable, colador, tapa, pulido brillante

set de 3: gobelet en acier inox, tamis, couvercle, poli brillant

	Ø cm	↑ cm	ltr.	€
36010	8,5	20	0,5	15,00
36011	9,0	23	0,7	19,20



Shaker „CLASSIC“

shaker
coctelera
shaker



3-teiliges Set: Edelstahlbecher, Siebaufsatz, Deckel, Kupfer-Look, hochglanzpoliert

3 pieces: stainless steel mug, strainer, lid, copper look, mirror polished

set de 3: taza de acero inoxidable, colador, tapa, cobre, pulido brillante

set de 3: gobelet en acier inox, tamis, couvercle, cuivre, poli brillant

	Ø cm	↑ cm	ltr.	Farbe / Colour	€
93211	8,5	20	0,5	copper-look	17,30
93212	9,0	23	0,7	copper-look	22,10



Shaker „CLASSIC“

shaker
coctelera
shaker



3-teiliges Set: Edelstahlbecher, Siebaufsatz, Deckel

3 pieces: stainless steel mug, strainer, lid

set de 3: taza de acero inoxidable, colador, tapa

set de 3: gobelet en acier inox, tamis, couvercle

	Ø cm	↑ cm	ltr.	Farbe / Colour	€
93366	9,0	23	0,7	stainless-antique	21,60
93326	9,0	23	0,7	copper-antique	21,60

SHAKERS



Parisian Shaker

shaker
coctelera
shaker



2-teiliges Set, Edelstahlbecher, mattiert

2 pieces, stainless steel cup, matt polished
set de 2, taza de acero, pulido mate
set de 2, gobelet en acier, poli mat

	Ø cm	↑ cm	ltr.	€
93179	9,5	24	0,7	17,90



Boston Shaker

boston shaker
coctelera boston
shaker boston



2-teiliges Set: Becher, 700 ml + Glas, 400 ml

2 pcs.: beaker, 700 ml + glass, 400 ml
set de 2: vaso coctelero, 700 ml+ vaso vidrio 400 ml
set de 2: bol mélangeur, 700 ml + bol en verre 400 ml

	Ø cm	↑ cm	ltr.	Farbe / Colour	€
93140	9	30	0,7 / 0,4	stainless-steel	14,80
93350	9	30	0,7 / 0,4	stainless-antique	15,30
93325	9	30	0,7 / 0,4	copper-antique	15,30
93201	9	30	0,7 / 0,4	copper-look	15,30

Ersatzglas / spare glass / vaso de recambio / verre de rechange

	Ø cm	↑ cm	ltr.	€
93138	8,5	14,5	0,4	9,30



Boston Shaker

boston shaker
coctelera boston
shaker boston



2-teiliges Set: Becher, 700 ml, gummiert, rutschfest + Glas, 400 ml

2 pcs.: beaker, 700 ml, rubberized, anti-slip + glass, 400 ml
set de 2: vaso coctelero con goma exterior 700 ml + vaso de vidrio 400 ml
set de 2: bol mélangeur inox extérieur plastifié couleur 700 ml + bol en verre 400 ml

	Ø cm	↑ cm	ltr.	Farbe / Colour	€
93139	9	30	0,7		15,20

Ersatzglas / spare glass / vaso de recambio / verre de rechange

	Ø cm	↑ cm	ltr.	€
93138	8,5	14,5	0,4	9,30

JIGGERS



Barmaß
jigger
medidor jigger
mesure double jigger



schnelles und genaues Abmessen von Spirituosen, mit Füllstrich
quick and exact measuring of spirits, with fill line
medida rápida y exacta de licores, con línea de llenado
mesure exact et rapide des spiritueux, avec ligne de remplissage

	Ø cm	↑ cm	ltr.	Farbe / Colour		€
93351	4,5	9	2 / 4		stainless-steel-polished	7,60
93354	4,5	9	2 / 4		stainless-antique	8,70



Barmaß
jigger
medidor jigger
mesure double jigger



schnelles und genaues Abmessen von Spirituosen, mit Füllstrich
quick and exact measuring of spirits, with fill line
medida rápida y exacta de licores, con línea de llenado
mesure exact et rapide des spiritueux, avec ligne de remplissage

	Ø cm	↑ cm	ltr.	Farbe / Colour		€
93353	4,5	9	2 / 4		copper-look	10,90
93352	4,5	9	2 / 4		copper-antique	10,90



Barmaß
jigger
medidor jigger
mesure double jigger



schnelles und genaues Abmessen von Spirituosen, mit Füllstrich
quick and exact measuring of spirits, with fill line
medida rápida y exacta de licores, con línea de llenado
mesure exact et rapide des spiritueux, avec ligne de remplissage

	Ø cm	↑ cm	ltr.	Farbe / Colour		€
93164	4,5	9	1,5 / 2,5 / 3,5 / 5		stainless-steel-polished	8,70
93355	4,0	11	1,5 / 2,5 / 3,5 / 5		stainless-antique	9,80



Barmaß
jigger
medidor jigger
mesure double jigger



schnelles und genaues Abmessen von Spirituosen, mit Füllstrich
quick and exact measuring of spirits, with fill line
medida rápida y exacta de licores, con línea de llenado
mesure exact et rapide des spiritueux, avec ligne de remplissage

	Ø cm	↑ cm	ltr.	Farbe / Colour		€
93165	4,5	9	1,5 / 2,5 / 3,5 / 5		copper-look	13,10
93324	4,0	11	1,5 / 2,5 / 3,5 / 5		copper-antique	13,10

JIGGERS



Barmaß
jigger
medidor jigger
mesure double jigger



hochglanzpoliert, schnelles und genaues Abmessen von Spirituosen, mit Füllstrich
mirror polished, quick and exact measuring of spirits, with fill line
pulido brillante, medida rápida y exacta de licores, con línea de llenado
poli miroir, mesure exact et rapide des spiritueux, avec ligne de remplissage

	∅ cm	↑ cm	cl.	€
93356	5	9	1 / 1,5 / 2 / 3 / 4 / 6	13,10



Barmaß
jigger
medidor jigger
mesure double jigger



hochglanzpoliert, schnelles und genaues Abmessen von Spirituosen, mit Füllstrich
mirror polished, quick and exact measuring of spirits, with fill line
pulido brillante, medida rápida y exacta de licores, con línea de llenado
poli miroir, mesure exact et rapide des spiritueux, avec ligne de remplissage

	∅ cm	↑ cm	cl.	€
93357	3,5	7,5	3 / 5	5,50



Barmaß
jigger
medidor jigger
mesure double jigger



hochglanzpoliert, schnelles und genaues Abmessen von Spirituosen, mit Füllstrich
mirror polished, quick and exact measuring of spirits, with fill line
pulido brillante, medida rápida y exacta de licores, con línea de llenado
poli miroir, mesure exact et rapide des spiritueux, avec ligne de remplissage

	∅ cm	↑ cm	cl	€
93121	4,0 / 3,5	8,5	2 / 4	5,50
93112	4,5 / 4,0	8,5	2,5 / 5	5,90



Barmaß
jigger
medidor jigger
mesure double jigger



hochglanzpoliert, schnelles und genaues Abmessen von Spirituosen, mit Füllstrich
mirror polished, quick and exact measuring of spirits, with fill line
pulido brillante, medida rápida y exacta de licores, con línea de llenado
poli miroir, mesure exact et rapide des spiritueux, avec ligne de remplissage

	∅ cm	↑ cm	cl	€
93120	4,5 / 3,5	7,0	2 / 4	5,10



Barmaß
jigger
medidor jigger
mesure double jigger



hochglanzpoliert, schnelles und genaues Abmessen von Spirituosen, mit Füllstrich
mirror polished, quick and exact measuring of spirits, with fill line
pulido brillante, medida rápida y exacta de licores, con línea de llenado
poli miroir, mesure exact et rapide des spiritueux, avec ligne de remplissage

	∅ cm	↑ cm	cl	€
93116	6 / 5	6	2 / 4	4,70

BAR SPOONS

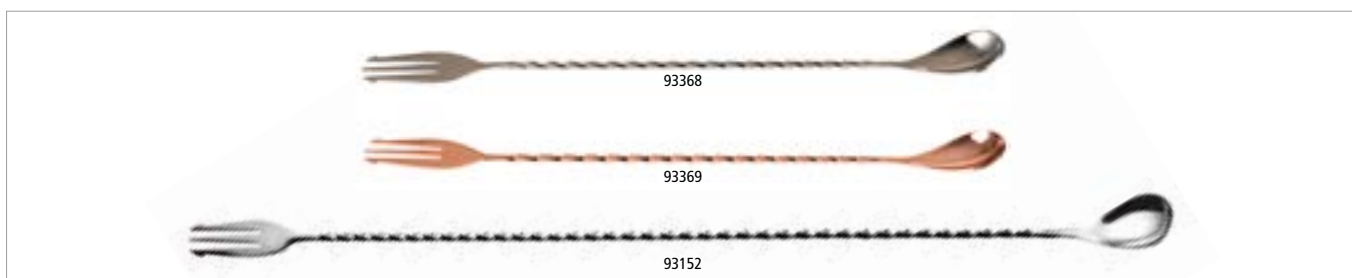

Barlöffel / -gabel
bar spoon
cucharilla de cóctel trident
cuillère de bar trident



	→ cm	Farbe / Colour		€
93368	30		stainless steel	7,00
93369	30		copper-look	9,90
93152	50		stainless steel	8,00

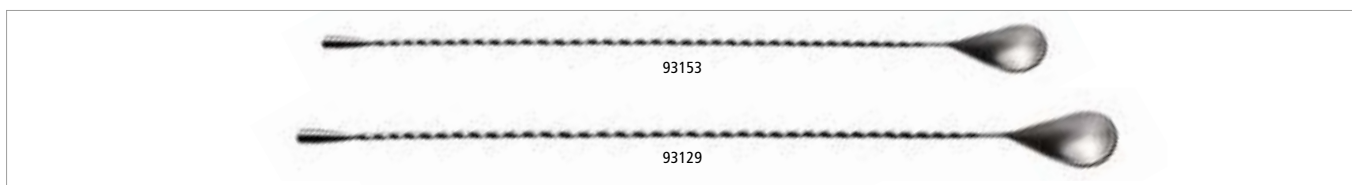

Barlöffel
bar spoon
cucharilla de cóctel
cuillère à cocktail



	→ cm	Farbe / Colour		€
93153	40		stainless steel	6,20
93129	44		stainless steel	9,80

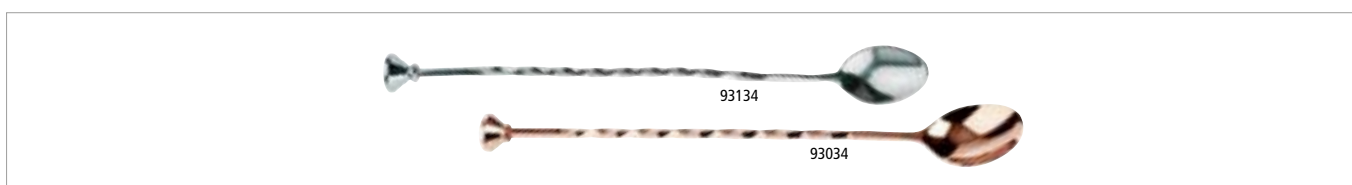

Barlöffel
bar spoon
cucharilla de cóctel
cuillère à cocktail



	→ cm	Farbe / Colour		€
93134	27		stainless steel	5,90
93034	27		copper-look	8,60



BAR STRAINERS



Barsieb

bar strainer
colador de cóctel
tamis cocktail



Spiralfeder hält Eiswürfel beim Abseihen zurück, Feder kann zur Reinigung entnommen werden, passend für alle Gläser und Shaker

coil spring keeps ice cubes in shaker, spring can be taken off for cleaning, suitable for all glasses and shakers

con muelle para mantener los cubitos en la coctelera, el muelle se desmonta para limpiar, se adapta a todos los tipos de vasos y cocteleras

avec ressort pour garder les glaçons dans le shaker, ressort démontable pour lavage, s'adapte à tous types de verres mélangeurs et shakers

	Ø cm	Griff / handle cm	Farbe / Colour		€
93347	9	9		copper-antique	13,10
93348	9	9		copper-look	13,10
93349	9	9		stainless-antique	13,10
93312	9	9		stainless steel	11,40



Einhandgebrauch
single-handed use



Barsieb

bar strainer
colador de cóctel
tamis cocktail



hochglanzpoliert, Spiralfeder hält Eiswürfel beim Abseihen zurück, Feder kann zur Reinigung entnommen werden, passend für alle Gläser und Shaker

mirror polished, coil spring keeps ice cubes in shaker, spring can be taken off for cleaning, suitable for all glasses and shakers

pulido brillante, con muelle para mantener los cubitos en la coctelera, el muelle se desmonta para limpiar, se adapta a todos los tipos de vasos y cocteleras

poli brillant, avec ressort pour garder les glaçons dans le shaker, ressort démontable pour lavage, s'adapte à tous types de verres mélangeurs et shakers

	Ø cm	Griff / handle cm		€
93300	8	6		5,50



Julep Barsieb „PRO“

julep strainer
colador de cóctel
tamis cocktail



hochglanzpoliert, Einhandgebrauch

mirror polished, single-handed use

pulido brillante, uso con una sola mano

poli brillant, utilisation d'une seule main



	Ø cm	Griff / handle cm		€
93313	7,5	9		9,80



Barsieb
bar strainer
colador de cóctel
tamis cocktail



	Ø cm	↑ cm	Griff / handle cm	€
93318	8,5	5	11,5	4,50



Schneidebrett „BAR“
cutting board
table de corte
planche à découper



HDPE, mit Safrinne, mit Antirutschfüßchen
HDPE, with juice groove and non-slip feet
HDPE, con ranura para líquidos y pies antideslizantes
HDPE, avec rigole et pieds antidérapants

	cm	↑ cm	€
93306	30 x 20	2	26,80
93307	50 x 30	2	36,00



Cocktailmesser „ORANGE“
bar knife
cuchillo para cóctel
couteau cocktail



mit 2 Zinken zum Aufspießen von Zitrusseiben
with 2 prongs to pick up slices of lemon
con 2 dientes para pinchar las rodajas de limón, etc.
avec 2 dents pour les rondelles de citron et autres décorations

	→ cm	€
88846	21	4,80



Dekoriermesser „ORANGE“
decorating knife „cannelé“
cuchillo acanalador
couteau canneléur



gezahnte Klinge aus geschärftem Edelstahl
serrated sharpened blade, stainless steel
hoja de sierra afilada, acero inoxidable
lame inox microdentée

	→ cm	€
88843	19	5,90



Zutatenbehälter
condiment holder
dispensador de especias
boîte à fruits et ingrédients



500 ml Inhalt pro Fach, 6 Fächer, inklusive Deckel (gefrostet) zur Lagerung
6 chambers á 500 ml, including lid for storing
6 compartimentos de 500 ml., incluye tapa para el almacenaje
6 compartiments de 500 ml chacun, avec couvercle pour le stockage

	cm	↑ cm	€
93171	50 x 16	10	23,50

Ersatzbehälter / replacement container / recipiente de recambio / récipient de remplacement

	cm	↑ cm	fits to	€
93176	14 x 7,5	7,5	93171	2,00



MUDDLERS



Stößel
muddler
mortero
pilon muddler



mit griffigem Ende, zum Auspressen von Früchten und Zerstoßen von Würfelzucker
with handy end, to press fruits or pound lump sugar
con un acabado en relieve para exprimir frutas y machacar azucarillos
avec relief grillagé pour presser les fruits ou le sucre en morceaux

	Ø cm	→ cm		Farbe / Colour	€
93358	3,5	20,5	stainless steel		7,20
93360	3,5	20,5	copper-look		9,20
93361	3,5	20,5	stainless-antique		9,20
93362	3,5	20,5	copper-antique		9,20



Stößel
muddler
mortero
pilon muddler



grober Stößel, zum Auspressen von Früchten und Zerstoßen von Würfelzucker
coarse notched, to press fruits or pound lump sugar
mortero grueso con muescas para exprimir frutas y machacar azucarillos
muddler grand format avec bout relief étoile pour presser les fruits ou le sucre en morceaux

	Ø cm	→ cm		Farbe / Colour	€
93181	2,5	21			4,20
93182	4	24			8,60



Stößel
muddler
mortero
pilon muddler



aus Buchenholz, mit griffigem Ende, zum Auspressen von Früchten und Zerstoßen von Würfelzucker
beech wood, with handy end, to press fruits or pound lump sugar
madera de haya, acabado relieve para prensar frutas o azucar
bois de hêtre, avec relief grillagé pour presser les fruits ou le sucre en morceaux

	Ø cm	→ cm		Farbe / Colour	€
93180	2,5	21			3,80

LIME AND LEMON SQUEEZERS



Limetten- / Zitronenpresse

lime- / lemon squeezer
exprimidor de limón / lima
presse citron



2 Pressringe für Zitrone und Limette
2 squeezing rings for lemon and lime
2 anillos exprimidores para limón y lima
2 anneaux à presser pour le citron et le lime

	cm	↑ cm	€
93214	21 x 7	5	14,60



Limettenpresse

lime squeezer
prensa de limón
presse citron



	cm	↑ cm	€
93189	21 x 7	5	11,40



Zitruspresse

citrus squeezer
exprimidor cítricos
presse-citron



hochglanzpoliert, 2-teilig
mirror polished, 2 pcs.
pulido brillante, 2 piezas
poli brillant, 2 pièces

	Ø cm	↑ cm	ltr.	€
71431	12 / 17	10,5	0,35	13,80

ICE CUBE MAKERS



Eiswürfel | ice cube
4 x 4 x 4 cm

Eiswürfelform mit Deckel, 2er Set

ice cube maker with lid, 2 pcs.
molde para cubitos de hielo con tapa, set de 2
moule à glaçons avec couvercle, set de 2

2 Eiswürfelformen für je 9 Stk. Eiswürfel

2 ice cube moulds for 9 ice cubes each

2 moldes de cubitos de hielo para 9 cubitos cada uno

2 moules à glaçons pour 9 glaçons chacun



	cm	↑ cm	ice cubes	pcs.	€/ set
36102	15,5 x 15,5	5,5	4 x 4 x 4	2	17,00



Die Eiswürfel lassen sich leicht auslösen
the ice cubes are easy to release

Eiswürfel | ice cube
4 x 2,5 x 3 cm

Eiswürfelform mit Deckel, 2er Set

ice cube maker with lid, 2 pcs.
molde para cubitos de hielo con tapa, set de 2
moule à glaçons avec couvercle, set de 2

2 Eiswürfelformen für je 21 Stk. Eiswürfel

2 ice cube moulds for 21 ice cubes each

2 moldes de cubitos de hielo para 21 cubitos cada uno

2 moules à glaçons pour 21 glaçons chacun



	cm	↑ cm	ice cubes	pcs.	€/ set
36103	25 x 15	4	4 x 2,5 x 3	2	13,00



Eiskugel | ice ball
Ø 6 cm

Eiskugelformer

ice ball former
molde de cubitos de hielo esféricos
moule à glaçons en boules

2-teilig, 3 Kugeln à 100 ml, einfach mit Wasser füllen und gefrieren lassen

3 bowls à 100 ml, simply fill with water and allow to freeze

3 bolas de 100 ml, simplemente llenar con agua y dejar congelar

3 boules à 100 ml, simplement remplir avec de l'eau et mettre à congeler



	cm	↑ cm	ice balls	€
12990	23,5 x 8,5	6,5	Ø 6	12,00



Eisbox
icebox
cubitera
seau à glaçons



Innenbehälter dient als Tropfeinsatz, hält die Eiswürfel bis zu 5 Stunden in ihrer Form
inner container serves as drainer, ice bucket keeps the ice cubes in shape for up to 5 hours
contenedor interior sirve como inserto de goteo, mantiene los cubitos de hielo en forma hasta 5 horas
réceptier intérieur sert d'égouttoir, maintient les glaçons dans leur forme jusqu'à 5 heures

	cm	↑ cm	ltr.		€
93220	27 x 27	15	5	max. 300 ice cubes	49,00



Eisbox
icebox
cubitera
seau à glaçons



Innenbehälter dient als Tropfeinsatz, hält die Eiswürfel bis zu 5 Stunden in ihrer Form
inner container serves as drainer, ice bucket keeps the ice cubes in shape for up to 5 hours
contenedor interior sirve como inserto de goteo, mantiene los cubitos de hielo en forma hasta 5 horas
réceptier intérieur sert d'égouttoir, maintient les glaçons dans leur forme jusqu'à 5 heures

	cm	↑ cm	ltr.		€
93200	20 x 20	17	3,4	max. 150 ice cubes	33,00



Eisbox
icebox
cubitera
seau à glaçons



Innenbehälter dient als Tropfeinsatz, hält bis zu 5 Stunden die Eiswürfel in ihrer Form
inner container serves as drainer, keeps the ice cubes in shape for up to 5 hours
contenedor interior sirve como inserto de goteo, mantiene los cubitos de hielo en forma hasta 5 horas
réceptier intérieur sert d'égouttoir, maintient les glaçons dans leur forme jusqu'à 5 heures

	Ø cm	↑ cm	ltr.		€
36033	18,5	20	3	max. 150 ice cubes	43,80
36037	27	20	6	max. 300 ice cubes	57,00



Eiseimer-Set mit Eiszange
ice bucket set with tong
cubitera clásica con pinza
seau à glaçons classique avec pince



mit Abtropfgitter, isolierter Kunststoffeinsatz, Zange lässt sich im Deckel verstauen, für max. 50 Eiswürfel, hält die Eiswürfel bis zu 5 Stunden in ihrer Form
with drainer, insulated plastic insert, tongs can be stored in the lid, for max. 50 ice cubes, keeps the ice cubes in shape for up to 5 hours
con escurridor, inserto de plástico aislado, la pinza se puede guardar en la tapa, para un máximo de 50 cubitos de hielo, mantiene los cubitos de hielo en forma hasta 5 horas
avec égouttoir, insert en plastique isolé, la pince peut être rangée dans le couvercle, pour max. 50 glaçons, maintient les glaçons dans leur forme jusqu'à 5 heures

	Ø cm	↑ cm	ltr.		€
36015	14	22	1,3		30,00

ICE BUCKETS



Eiseimer-Set mit Eiszange

ice bucket set with tong
cubitera clásica con pinza
seau à glaçons classique avec pince

für max. 45 Eiswürfel, hält die Eiswürfel bis zu 5 Stunden in ihrer Form

max. 45 ice cubes, keeps the ice cubes in shape for up to 5 hours

para un máximo de 45 cubitos de hielo, mantiene los cubitos de hielo en forma hasta 5 horas
pour max. 45 glaçons, maintient les glaçons dans leur forme jusqu'à 5 heures



	Ø cm	↑ cm	ltr.	€
36013	12	14	1	32,00



3-teiliges Set
3 pcs.



Eiszerkleinerer

Ice crusher
picadora de hielo
broyeur à glaçons

glasklar, mit Edelstahl-Messer

clear, stainless steel cutters
cuchillas de acero inoxidable
couteaux inox



	cm	↑ cm	€
36017	12 x 12	24	18,10



Eisschaufel

ice scoop
pala de hielo
pelle à glaçons



	cm	→ cm	ltr.	€
93192	10 x 6	29	0,7	8,90



Eisschaufel

ice scoop
pala de hielo
pelle à glaçons

gelocht, ideal zum Befüllen von schlanken Gläsern

perforated, ideal to fill narrow glasses

perforada, ideal para llenar vasos estrechos

perforée, idéale pour verser les glaçons dans des verres étroits



	Ø cm	→ cm	€
93191	5	19,5	7,00



Eiszange

ice tongs
pinzas para hielo
pince de la glace

hochglanzpoliert, mit Befestigungsclip

mirror polished, with fastening clip
pulido brillante, con clip de fijación
poli brillant, avec clip de fixation



	→ cm	Farbe / Colour	€
75853	20	stainless steel	4,20
75854	20	copper-look	4,60
75855	20	gunmetal-look	4,60



Zange kann an einer Schale befestigt werden
tongs can be attached to a bowl

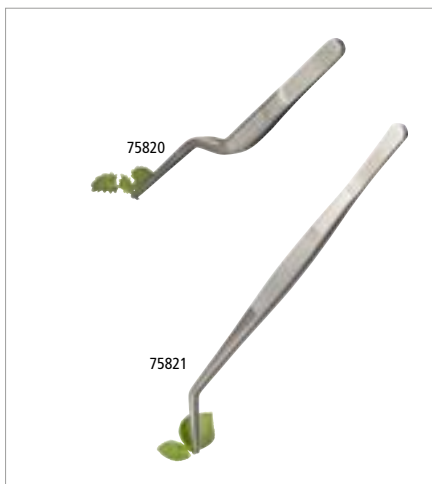

Pinzettenzange

fine tong / tweezer
pinza de emplatat
pince à dresser

hochglanzpoliert, geriffelte Grifffläche, schwere Qualität

mirror polished, ribbed handle, heavy gauge
pulido brillante, mango cómodo ranurado, alta calidad
poli brillant, manche rainuré antiglisse, qualité extra



	→ cm	€
75820	16	6,60
75821	30	9,90



Eiszange

ice cube tong
pinza para cubitos de hielo
pince à glaçons

hochglanzpoliert, fugenlos

mirror polished, seamless
pulido brillante, de una sola pieza
poli brillant, d'une seule pièce



	cm	→ cm	€
75805	5 x 2	17,5	2,40



Eiszange

ice tong
pinza para cubitos de hielo
pince à glaçons

matt poliert, mit griffigem Ende, ideal für Eiswürfel und Obstscheiben

matt polished, with handy end, ideal for ice cubes and fruit slices
pulido mate, forma ergonómica ideal para cubitos de hielo y láminas de fruta
poli mat, forme ergonomique idéale pour glaçons et fruits tranchés



	cm	→ cm	€
93190	2 x 1,5	20	6,20



STRAWS



Trinkhalme 11er Set

straws, 11 pcs. set
pajas, set de 11 pz.
pailles, set de 11 pc.



11-teiliges Set: 10 Trinkhalme aus Edelstahl + Reinigungsbürste

11 pcs. set: 10 drinking straws made of stainless steel + cleaning brush
set de 11: 10 pajas de acero inoxidable + cepillo de limpieza
set de 11: 10 pailles en acier inox + brosse de nettoyage

	Ø mm	→ cm	Farbe / Colour	€/ set
93391	8	15,0		copper-look 12,00
93392	8	15,0		gunmetal-look 12,00
93393	8	15,0		rainbow-look 12,00
93380	6	21,5		copper-look 13,00
93381	6	21,5		gunmetal-look 13,00
93382	6	21,5		rainbow-look 13,00
93383	8	21,5		copper-look 14,00
93384	8	21,5		gunmetal-look 14,00
93385	8	21,5		rainbow-look 14,00

Ersatzbürste / replacement brush / cepillo de recambio / brosse de rechange

	Ø mm	→ cm	€
93395	8	15	1,30
93386	8	20	2,60



Trinkhalme 7er Set

straws, 7 pcs. set
pajas, set de 7 pz.
pailles, set de 7 pc.



	Ø mm	→ cm	pcs.	€/ set
93394	10	15	7	7,00
93390	10	21	7	8,00





Barmatte

drip mat
tapete escurridor
tapis de bar

aus weichem Kunststoff, zum Abtropfen von Gläsern etc.
soft plastic, to store and drain glasses
plástico blando para escurrir vasos
plastique souple, pour l'égouttage des verres



	cm	↑ cm	Farbe / Colour		€
93168	60 x 8	1		mit Vertiefung	10,00
93166	30 x 15	1		ohne Vertiefung	7,60
93173	52 x 8	1		ohne Vertiefung	9,40
93169	60 x 8	1		ohne Vertiefung	10,00
93167	45 x 31	1		ohne Vertiefung	20,60

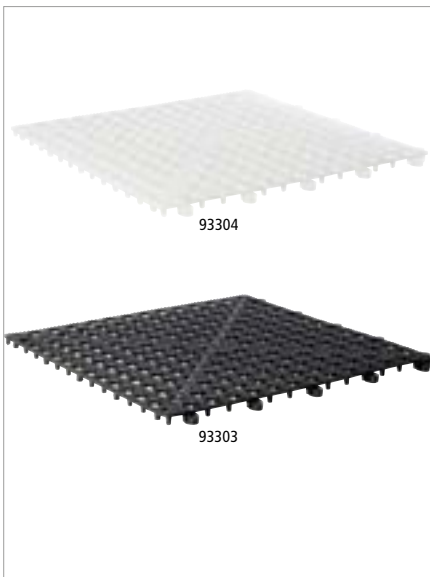

Abtropfmatte

drip mat
esterilla escurridora
tapis égouttoir

erweiterbar durch Klick-Verbindung
expandable
las placas de fijan con clips
avec clips de fixation



	cm	↑ cm	Farbe / Colour		€
93304	33 x 33	1,5			6,40
93303	33 x 33	1,5			6,40



Glasumrand

glass rimmer
ribeteador de vasos
bordeur à verres „rimmer“

Schwamm für Limettensaft, 2 Fächer für Zucker und Salz
with sponge for lime juice, 2 cases for sugar and salt
con esponja para zumo de lima, 2 compartimentos para azucar y sal
avec éponge et 2 compartiments pour sucre et sel



	cm			€
93175	20 x 7,5			10,40



Bar Caddy

bar caddy
organizador de bar
organisateur „bar caddy“

Ordnungshilfe für Trinkhalme, Rührer, Servietten, Streichhölzer, etc.
to organize straws, stirrers, napkins, matches, etc.
para organizar pajitas, cucharillas, servilletas, cerillas, etc.
pour bien organiser les pailles, agitateurs, cuillers, serviettes et autres accessoires



	cm	↑ cm		€
93174	24 x 15	11		8,80

CONFERENCE BOTTLE COOLERS



00621

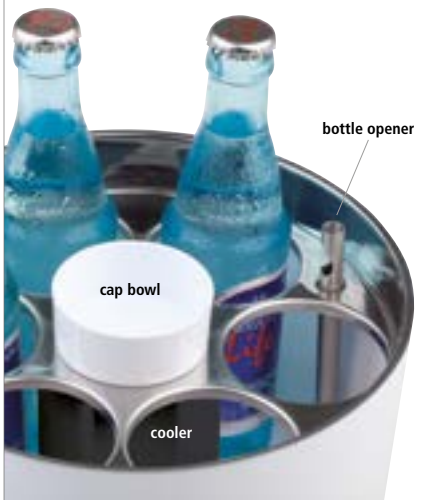

bottle opener

cap bowl

cooler

Flaschenkühler „CONFERENCE“

conference bottle cooler
enfriador múltiple
rafraîchisseur



inkl. Kühllakku, Flaschenöffner, Kronkorkenschale,
mit 6 Öffnungen Ø 6,7 cm für 0,25 - 0,5 Liter-Flaschen

incl. bottle cooler, bottle opener, small cap bowl,
with 6 holes Ø 6,7 cm for 0,25 to 0,5 liter bottle

con acumulador de frío, abridor, recuperador de chapas,
6 plazas Ø 6,7 cm, para botellas de 25 a 50 cl

avec accumulateur de froid, décapsuleur, bol récupérateur
de capsules, 6 places Ø 6,7 cm, pour bouteilles de 25 à 50 cl

	Ø cm	↑ cm	Farbe / Colour	€
00620	23	15	White	54,00
00621	23	15	Black	54,00

Kühllakku / cooler / acumulador de frío / accumulateur de froid

	Ø cm	↑ cm	Farbe / Colour	€
00615	7,5	11,5	Black	10,50

Kronkorkenschale / cap bowl / cuenco para chapas / bol récupérateur de capsules

	Ø cm	↑ cm	Farbe / Colour	€
00618	6,5	3	White	2,50
00619	6,5	3	Black	2,50

Flaschenöffner / bottle opener / abridor / décapsuleur

	Ø cm	→ cm	€
00617	1	13,5	6,10



Staubkappen, 2er Set

dust & fly cap, 2 pcs.
tapón antipolvo
bouchon anti-poussières et anti-insectes



schützt vor Staub und Insekten

protects for dust and insects

para proteger de la suciedad e insectos

pour protéger de la poussière et des insectes

	Ø cm	↑ cm	Farbe / Colour	pcs.	€ / set
93161	4	8	Black	2	4,90

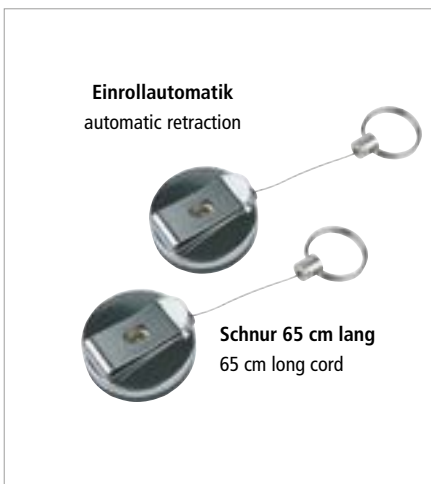

Einrollautomatik
automatic retraction

Schnur 65 cm lang
65 cm long cord

Schlüsselschnur, 2er Set

key cord, 2 pcs.
llavero enrollable
porte-clés avec câble à enroulement



Befestigung mit Klammer am Gürtel, starke Rückzugfeder

to fix at waistbelt, strong pull-back spring

se fija en el cinturón, cable retrocede automáticamente

à fixer à la ceinture, enroulage automatique

	Ø cm	↑ cm	€
93170	4	2	7,60



Dosier- & Vorratsflasche

pouring container
botella „store & pour“
bouteille „store & pour“



4-teilig: Behälter + Flaschenhals + Schraubdeckel + Ausgießer Ø 11 mm mit Luftzufuhr für gezieltes Ausgießen, zum Dosieren und Aufbewahren

4 pcs. set: for storage, mixing and serving drinks, nozzle Ø 11 mm

set de 4 piezas: para almacenar y servir mezclas y bebidas, agujero de Ø 11 mm

se compose de 4 pièces: idéal pour servir et pour conserver les boissons, embout Ø 11 mm

	Ø cm	↑ cm	ltr.	Farbe / Colour	€
93144	9	33	0,85		5,90
93145	9	33	0,85		5,90
93146	9	33	0,85		5,90
93147	9	33	0,85		5,90
93148	9	33	0,85		5,90



abnehmbarer Boden dient als Deckel
removable bottom serves as a lid



93308 200 ml



93309

Spritzflasche inklusive Ausgießer

squeeze bottle with nozzle
botella exprimible con dosificador
flacon pulvérisateur avec bec verseur

ideal für Bitter-Liköre, Essig, Öl

perfect for bitter liqueur, vinegar, oil

perfecto para amargo licor, vinagre, aceite

pour amaro liquore, vinaigre, huile



	cm	↑ cm	ltr.	€
93308	6 x 5	20	0,2	9,90

Ausgießer passend für Spritzflasche / nozzle suitable for squeeze bottle / dosificador apto para botella exprimible / bec verseur approprié pour flacon pulvérisateur

	Ø cm	↑ cm	€
93309	2,5	5,5	2,80



93141 0,5 ltr.

93101 1,0 ltr.

Rührglas mit Lippe

mixing glass with lip
vaso mezclador vertedor con pico
verre mélangeur avec bec verseur

schwere Qualität

heavy quality

alta calidad

qualité renforcée



	Ø cm	↑ cm	ltr.	€
93141	9	16	0,5	11,40
93101	11,5	19	1,0	11,40

POURERS



Permanent-Ausgießer, 6er Set
 free flow pourer, 6 pcs.
 vertedor contínuos set 6 piezas
 set de 6 bouchons verseurs continus



	↑ cm	pcs.	€/ set
93110	11	6	14,00



Permanent-Ausgießer, 6er Set
 free flow pourer, 6 pcs.
 vertedor contínuos set 6 piezas
 set de 6 bouchons verseurs continus



	↑ cm	pcs.	€/ set
93114	8	6	13,40



Sekt-Verschluss, 2er Set
 stopper, 2 pcs.
 set de 2 taponos
 set de 2 bouchons



matt poliert, innen Gummi Arabicum
 matt polished, inside rubber arabicum, with inscription
 pulido mate, interior goma arábica con inscripción
 poli maté, intérieur gomme arabique

	Ø cm	↑ cm	pcs.	€/ set
93160	4	5,5	2	8,90



Permanent-Ausgießer, 6er Set
 free flow pourer, 6 pcs.
 vertedor contínuos set 6 piezas
 set de 6 bouchons verseurs continus



à 2 Stück: blau, rot, gelb
 2 pcs of each colour: blue, red, yellow
 2 piezas de cada color: azul, rojo, amarillo
 2 par couleur: bleu, rouge, jaune

	Ø cm	↑ cm	pcs.	€/ set
93111	3	7,5	6	5,60



Reinigungsbürste für Ausgießer
 pourer cleaning brush
 cepillo de limpieza para picos vertedores
 brosse lave-bouchons doseurs



	→ cm	€
93102	16,5	2,80



Kellnermesser „PROFI“

waiter's corkscrew
sacacorchos de camarero
tire-bouchons



leichtgängige Teflon-Spirale, mehrstufige Klapphebelfunktion, am Fuß angebrachtes Messer
easy moving teflon coil, 2-stage opening system, knife at the bottom end
mecha de teflón, sistema de apertura en 2 golpes, con cuchillo en la parte superior
mèche téflon, ouverture en 2 étapes, couteau dans la partie supérieure

	→ cm	€
93302	11,5	10,80



Kellnermesser

waiter's corkscrew
sacacorchos de camarero
tire-bouchons



leichtgängige Teflon-Spirale, mehrstufige Klapphebelfunktion, am Kopf angebrachtes Messer
easy moving teflon coil, 2-stage opening system, knife at the top end
mecha de teflón, sistema de apertura en 2 golpes, con cuchilla en la parte superior
mèche téflon, ouverture en 2 étapes, couteau dans la partie supérieure

	→ cm	€
93301	12	5,20



Kellner-Flaschenöffner

waiter's barblade
abridor camarero
décapsuleur



matt poliert / matt polished / pulido mate / poli mat

	→ cm	€
93122	18	3,70
00617	13,5	6,10



mit Gummierung
with rubber coating

Kellner-Flaschenöffner

waiter's barblade
abridor camarero
décapsuleur



mit Gummierung
with rubber coating
con revestimiento de goma
avec revêtement en caoutchouc

	→ cm	€
93125	11	4,30



Kronkorkenöffner

bottle cap opener
abridor de chapas de pared
décapsuleur mural



für die Wandmontage, aus massivem Metall, inklusive 2 Schrauben
for wall fastening, massive metal, including 2 screws
para fijación en la pared, metal macizo, incluye 2 tornillos
massif, à fixer au mur, y compris 2 vis

	cm	↑ cm	€
93124	7 x 8	3	10,40

BARISTA

Life begins after coffee



10334

Milch-/Universalkanne

non stick jug
jarra antiadherente
pichet antiadhésif

PTFE-antihafbeschichtet, perfekt für die Herstellung von Milchschaum

PTFE coated, for baristas frothing hot milk
revestimiento PTFE, ideal para espume de leche
revêtement PTFE, idéal pour faire mousser le lait



	Ø cm	↑ cm	ltr.	€
10334	8,0	10,0	0,35	15,00
10335	9,0	11,5	0,60	18,20
10336	10,5	13,0	0,80	24,20



10329

Milch- / Universalkanne

milk / water jug
jarra leche / agua
pichet à eau / lait

außen hochglanzpoliert, innen matt poliert, mit Maßskalierung innen

outside mirror polished, inside matt polished, with dimension scaling inside
exterior pulido brillante, interior pulido mate, con escala de dimensiones en el interior
extérieur brillant, intérieur mat poli maté, avec une échelle de dimension à l'intérieur



	Ø cm	↑ cm	ltr.	€
10328	8,0	10,0	0,35	7,80
10329	9,0	11,5	0,6	11,20
10330	10,5	13,0	0,8	15,00
10331	12,0	16,5	1,3	22,00
10332	13,5	18,0	2,0	26,40



10350

Milch- / Universalkanne „VEGAN“

milk / water jug
jarra leche / agua
pichet à eau / lait

außen hochglanzpoliert, innen matt poliert, mit Gravur „VEGAN“

outside mirror polished, inside matt polished, with engraving „VEGAN“
exterior pulido brillante, interior pulido mate, con grabado „VEGAN“
extérieur brillant, intérieur mat poli maté, avec gravure „VEGAN“



	Ø cm	↑ cm	ltr.	€
10350	9,0	11,5	0,6	14,90
10351	10,5	13,0	0,8	18,90

NEW



10361

Milch- / Universalkanne

milk / water jug
jarra leche / agua
pichet à eau / lait



außen weiß pulverbeschichtet, innen matt poliert

outside white powder coated, inside matt polished
exterior recubrimiento de polvo blanco, interior pulido mate
extérieur revêtement en poudre blanc, intérieur mat poli maté

	Ø cm	↑ cm	ltr.	€
10360	8,0	10,0	0,35	16,00
10361	9,0	10,0	0,50	20,00
10362	9,5	11,5	0,75	22,00



mit Gravur am Boden
with engraving on the bottom



10323

Kaffeekanne

coffee pot
cafetera
pichet à café



hochglanzpoliert, mit Klappdeckel

mirror polished, with hinged cover
pulido brillante, tapa con bisagra
poli brillant, couvercle à charnière

	Ø cm	↑ cm	ltr.	€
10323	8,0	11,5	0,35	9,60
10322	9,0	14,0	0,6	13,00
10325	10,5	15,5	0,9	18,00
10326	12,0	18,5	1,5	24,40
10327	13,5	20,0	2,0	30,00

NEW



verstellbar durch Verschieben des Clips
adjustable by sliding the clip

Thermometer für Milchkännchen

thermometer for milk / water jug
termómetro para jarra leche / agua
thermomètre pour pichet à eau / lait



mit Clip, höhenverstellbar, Temperaturbereich 20°C bis 100°C, Graduierung 2°C

with clip, height adjustable, temperature range 20°C to 100°C, graduation 2°C
con clip, regulable en altura, rango de temperatura de 20°C a 100°C, graduación 2°C
avec clip, réglable en hauteur, plage de température 20°C à 100°C, graduation 2°C

	Ø cm	↑ cm	€
10355	4,0	13,5	6,00



Anwendungsbeispiel
application example



Mini-Milchkanne „SNACKHOLDER“ 4er Set

mini milk can, 4 pcs.
lechera en formato mini, set de 4
pot à lait mini, set de 4



	Ø cm	↑ cm	ltr.	pcs.	€ / set
40640	4,5	5	0,08	4	16,40



Milchkännchen / Sahnegießer, 4er Set

milk/cream jugs, 4 pcs.
pack de 4 jarritas para leche o crema
pack de 4 crémiers

hochglanzpoliert, für Kaffeesahne, mit Griff, Inhalt à 25 ml
mirror polished, for coffee-cream, with handle, capacity à 25 ml
pulido brillante, para crema de café, con asa, capacidad 25 ml
poli brillant, avec anse, 25 ml



	Ø cm	↑ cm	ltr.	pcs.	€ / set
10321	3,5	3,5	0,025	4	15,00



Milchkännchen / Sahnegießer

milk / cream jug
jarra de leche/ crema
pichet à eau ou lait



	Ø cm	↑ cm	ltr.	€
10318	4	4	0,05	2,40
10319	5	5	0,09	3,00
10320	6	6	0,15	3,60



Allzweckgießer

pourer
bote vertedor universal
pot verseur universel
für Honig, Kaffeesahne, etc., Schraubdeckel
for honey, cream, etc., screw cap
para miel, crema, etc., tapa de rosca
pour le miel, le lait, la crème, etc., bouchon à vis



	Ø cm	↑ cm	ltr.	€
00765	8,5	13,5	0,3	9,00

Ersatzglasbehälter / spare glas-container / contenedor de repuesto / récipient verre de rechange

00768				1,80
-------	--	--	--	------



Allzweckgießer

pourer
dosificador
doseur
für Honig, Kaffeesahne, etc., Schraubdeckel
for honey, cream, etc., screw cap
para miel, crema, etc., tapa de rosca
pour le miel, le lait, la crème, etc., bouchon à vis



	Ø cm	↑ cm	ltr.	€
40488	8	12,5	0,25	6,80



Milch- und Zucker-Set

bowl
cuenco
bol

5-teilig: Tablett, Milchkanne, Zuckerdose mit Deckel, Löffel, Akazienholz, Edelstahl PTFE beschichtet, schwarz

5 pcs.: tray, milk jug, sugar bowl with lid, spoon, acacia wood, stainless inox PTFE coated, black

set de 5: bandeja, jarra de leche, azucarero con tapa, cuchara, madera de acacia, acero inoxidable revestimiento PTFE, negro

set de 5: plateau, pichet à lait, sucrier avec couvercle, cuillère, bois d'acacia, acier inox revêtement PTFE, noir



	cm	↑ cm	€ / set
00634	19 x 10	10,5	24,00



Zuckerkugel

sugar pot
azucarero
sucrier

hochglanzpoliert, mit Rolldeckel

mirror polished, rolltop cover
pulido brillante, tapa abatible
poli brillant, couvercle abattant



	Ø cm	↑ cm	€
00033	13,5	15	14,40



170 ml

Zuckerdosierer

sugar dispenser
azucarero
sucrier

matt poliert, Deckel mit Bajonettverschluss / matt polished, lid with bayonet catch / pulido mate, tapa con cierre de bayoneta / poli mat, couvercle avec fermeture à baïonnette



	Ø cm	↑ cm	ltr.	€
10316	5	15	0,17	10,00



40509 200 ml

40508 200 ml

Zuckerdosierer

sugar dispenser
azucarero
sucrier

Schraubdeckel, mit Dosierrohr / screw cap, with dosing tube / tapa de rosca y tubo dosificador / bouchon à vis et tube doseur



	Ø cm	↑ cm	ltr.	€
40509	6	14,5	0,2	12,00
40508	6,5	14,5	0,2	11,50



300 ml

Zuckerdosierer

sugar dispenser
azucarero
sucrier

Schraubdeckel, mit Dosierrohr / screw cap, with dosing tube / tapa de rosca y tubo dosificador / bouchon à vis et tube doseur



	Ø cm	↑ cm	ltr.	€
00766	8,5	15	0,3	5,50

Ersatzglasbehälter / spare glass-container / contenedor de repuesto / récipient verre de rechange

	€
00768	1,80



320 ml

Zuckerdosierer

sugar dispenser
azucarero
sucrier

Schraubdeckel, mit Dosierrohr / screw cap, with dosing tube / tapa de rosca y tubo dosificador / bouchon à vis et tube doseur



	Ø cm	↑ cm	ltr.	€
40506	7,5	17,0	0,32	5,40



250 ml

Zuckerdosierer

sugar dispenser
azucarero
sucrier



Schraubdeckel, mit Dosierrohr / screw cap, with dosing tube / tapa de rosca y tubo dosificador / bouchon à vis et tube doseur

	Ø cm	↑ cm	ltr.	€
40486	8	15	0,25	3,90



40490 150 ml

40494 250 ml

Zuckerdosierer

sugar dispenser
azucarero
sucrier



Schraubdeckel, mit Dosierrohr / screw cap, with dosing tube / tapa de rosca y tubo dosificador / bouchon à vis et tube doseur

	Ø cm	↑ cm	ltr.	€
40490	8,5	12	0,15	3,90
40494	8,0	15	0,25	3,90

Ersatzglasbehälter / spare glas-container / contenedor de repuesto / récipient verre de rechange

	fits to	€
40498	40490	1,80
40499	40494	1,80



40487
320 ml

40510
350 ml

Zuckerdosierer

sugar dispenser
azucarero
sucrier



Schraubdeckel mit Klappe, mit Dosierklappe / screw cap, with dosing flap / tapa de rosca, con tubo dosificador / bouchon à vis, avec couvercle doseur

	Ø cm	↑ cm	ltr.	€
40487	7,5	13,5	0,32	4,80

Zuckerdosierer „OLD FASHIONED“ / sugar dispenser / azucarero / sucrier

	Ø cm	↑ cm	ltr.	€
40510	7,5	14	0,35	4,10



Teebrühsieb

snap mesh tea ball
infusor de té, pinza con malla
boule à thé avec pince



matt poliert, mit feinem Sieb, aufklappbar / matt polished, with fine mesh, hinged / pulido mate, con malla fina, con bisagra / poli mat, maille fine, avec charnière

	Ø cm	→ cm	€
74750	4,5	15,5	2,60



Zitronenschnitzpresse

lemon slice squeezer
pinza exprimelimon
pince presse citron



hochglanzpoliert, zum Auspressen von Zitronenscheiben / mirror polished, to press lemon slices / pulido brillante, para rodajas de limón / poli brillante, pour citrons en rondelle

	cm	€
71430	8 x 7	1,40

TEAPOTS



NEW



10995 0,8 ltr.



10996 0,8 ltr.

mit Teesieb / with tea strainer

Teekanne „ASIA“

teapot
tetera
théière

aus Gusseisen, innen emailliert, abnehmbarer Deckel, mit Teesieb aus Edelstahl

made of cast iron, enamelled inside, removable lid, with tea strainer made of stainless steel

hierro fundido, interior esmaltado, tapa extraíble, con colador de té de acero inoxidable

en fonte, émaillé à l'intérieur, couvercle amovible, avec une passoire à thé en acier inox

	cm	↑ cm	ltr.	Farbe / Colour	€
10995	17 x 14	17	0,8	■	26,00
10996	17 x 14	17	0,8	■	26,00



10991 0,8 ltr.



10992 0,8 ltr.

mit Teesieb / with tea strainer

Teekanne „ASIA“

teapot
tetera
théière

aus Gusseisen, innen emailliert, mit abnehmbarem Deckel,

inklusive Teesieb aus Edelstahl, ideal für 2-3 Tassen. Geeignet für alle Herdarten.

made of cast iron, enamelled inside, with removable lid, incl. tea strainer made of stainless steel, ideal for 2-3 cups. Suitable for all types of stoves.

hierro fundido, interior esmaltado, con tapa extraíble, incl. colador de té de acero inoxidable, ideal para 2-3 tazas. Apta para todas las placas de cocina.

en fonte, émaillé à l'intérieur, avec couvercle amovible, y compris une passoire à thé en acier inox, idéale pour 2-3 tasses. Convient à tous les types de feux (gaz, vitro ou induction).

	cm	↑ cm	ltr.	Farbe / Colour	€
10991	19,5 x 18	15	0,8	■	26,00
10992	19,5 x 18	15	0,8	■	26,00



0,3 ltr.

ohne Teesieb / without tea strainer

Teekanne „ASIA“

teapot
tetera
théière

aus Gusseisen, innen emailliert, mit abnehmbarem Deckel, ohne Teesieb aus Edelstahl

made of cast iron, enamelled inside, with removable lid, without tea strainer made of stainless steel

hierro fundido, interior esmaltado, con tapa extraíble, sin colador de té de acero inoxidable

en fonte, émaillé à l'intérieur, avec couvercle amovible, sans une passoire à thé en acier inox

	cm	↑ cm	ltr.	Farbe / Colour	€
10990	12,5 x 11	12,5	0,3	■	21,00



30130



30131



30132



30133



30140



30141



30142

Tablett „VINTAGE“

tray
bandeja
plateau

Antik-Edelstahl-Look
stainless steel antique look
acero estilo antiguo
acier style antique



	cm	↑ cm		€
30130	26,0 x 13,5	1,5	rectangular	8,00
30131	34,0 x 18,0	1,5	rectangular	13,20
30132	38,0 x 26,5	1,5	rectangular	21,00
30133	25,5 x 16,0	3,0	rectangular	16,00
30140	20,0 x 14,5	1,0	oval	5,00
30141	26,5 x 19,5	1,0	oval	7,60
30142	29,0 x 22,0	1,0	oval	9,80

passende Schälchen / fitting bowls / cuencos adecuados / bols apropiés



	Ø cm	↑ cm	litr.	€
40655	7,5	5,5	0,17	3,20
40656	7,5	10	0,35	4,00



Wachspapier „SNACKHOLDER“ / greaseproof paper squares
papel alimenticio para cucurucho / papier alimentaire pour cornet



	cm	pcs.		€ / set
40670	42 x 25	500	Motiv: Zeitung	59,00



30130



30132



30141

Servierbeispiel
presentation example

**Serviertablett „KAFFEEHAUS“**

tray
bandeja
plateau

matt poliert, Rand eingerollt

matt polished, rolled edge

acabado pulido efecto pulido mate, borde redondeado

effet poli mat, bord rond



	cm	↑ cm	€
30119	23 x 23	1,5	10,90
30118	21,5 x 13	1,5	7,90

**Serviertablett „KAFFEEHAUS“**

tray
bandeja
plateau

matt poliert, oval, Rand eingerollt

matt polished, oval, rolled edge

pulido mate, oval, borde redondeado

poli mat, ovale, bord rond

für Zucker und Sahne / for sugar and cream / para azúcar y crema / pour le sucre et la crème

	cm	↑ cm	€
30111	20,0 x 14,5	0,5	4,70

für eine Tasse / for one cup / para una taza / pour une tasse

	cm	↑ cm	€
30112	26,5 x 19,5	0,5	7,00

für zwei Tassen / for two cups / para dos tazas / pour deux tasses

	cm	↑ cm	€
30113	29,0 x 22,0	0,5	7,50

**Serviertablett „KAFFEEHAUS“**

tray
bandeja
plateau

hochglanzpoliert, oval, Rand eingerollt

mirror polished, oval, rolled edge

pulido brillante, ovalado, borde redondeado

poli brillant, ovale, bord rond

für Zucker und Sahne / for sugar and cream / para azúcar y crema / pour le sucre et la crème

	cm	↑ cm	€
30115	20,0 x 14,5	0,5	4,70

für eine Tasse / for one cup / para una taza / pour une tasse

	cm	↑ cm	€
30116	26,5 x 19,5	0,5	7,00

für zwei Tassen / for two cups / para dos tazas / pour deux tasses

	cm	↑ cm	€
30117	29,0 x 22,0	0,5	7,50



TRAYS



Serviertablett „KAFFEEHAUS“

tray
bandeja
plateau
matt poliert, oval
matt polished, oval
pulido mate, oval
poli mat, ovale



	cm	↑ cm	€
30126	25,5 x 19,5	2	6,40



Serviertablett „KAFFEEHAUS“

tray
bandeja
plateau
hochglanzpoliert, stabiler Rand eingerollt
mirror polished, stable edge rolled in
pulido brillante, borde estable enrollado
poli brillant, bord stable enroulé



	cm	↑ cm	€
30148	Ø 27	1,5	6,10
30149	30 x 15,5	1,5	7,00

passende Hauben / cover / campana / cloche



	cm	↑ cm	suitable for	€
11055	Ø 23	12,0	30148	5,70
11056	26 x 12	10,0	30149	7,90



Servierbeispiel
presentation example



Serviertablett „KAFFEEHAUS“

tray
bandeja
plateau
Innenfläche ziseliert, Rand eingerollt
chiselled inner surface, rolled edge
superficie interior cincelada, borde redondeado
surface intérieure ciselée bord rond



	cm	VE / unit	€ / pc.
30114	30 x 22	48	3,00



Serviertablett „KAFFEEHAUS“

tray
bandeja
plateau



	cm	↑ cm	Farbe / Colour	€
84251	26,0 x 20,0	1,5	■	4,80
84253	28,5 x 21,5	1,5	■	5,40



Tablett „BISTRO“

tray
bandeja
plateau

rutschfest, mit 2 Griffmulden und Stapelrand

non-slip, two open handles, stackable edge

anti-deslizante, 2 asas

antidérapant, 2 anses



	Ø cm	↑ cm	Farbe / Colour	€
84045	35,5	4,5	■	26,00



00510

Serviertablett „HAPPY HOUR“

tray
bandeja
plateau

rutschfeste Oberfläche

non-slip surface

superficie anti-deslizante

surface antidérapante



	Ø cm	↑ cm	Farbe / Colour	€
00510	32	1,5	■	23,00
00511	38	1,5	■	28,00
00515	43	1,5	■	32,00



00500

Bierglasträger „NON-SLIP“

beer rack

bandeja para cerveza

porte verre à bière

rutschfeste Oberfläche

non-slip surface

superficie anti-deslizante

surface antidérapante



	Ø cm	↑ cm	Farbe / Colour	€
00500	36	3,5	■	21,00

	cm	↑ cm	Farbe / Colour	€
00506	28 x 20	1,5	■	9,60



00548

Tablett „GASTRO“

tray
bandeja
plateau

rutschfeste Oberfläche

non-slip surface

superficie anti-deslizante

surface antidérapante



	Ø cm	↑ cm	Farbe / Colour	€
00547	27,5	2	■	7,60
00548	35,5	2	■	9,60
00549	40,5	2	■	11,40

TRAYS



Tablett

tray
bandeja
plateau

rutschfest, Mahagonifurnier

non-slip, woodform, mahogany
antideslizante
antidérapant



	Ø cm	↑ cm	€
00528	31,0	3,5	19,00
00529	35,5	3,5	25,00



Tablett

tray
bandeja
plateau

rutschfest, Holzdekor-Laminat

non-slip, coated wood
antideslizante
antidérapant



	cm	↑ cm	€
00521	26 x 20	1	8,60
00522	29 x 21	1	11,20



Tablett

tray
bandeja
plateau

rutschfest, Holzdekor-Laminat

non-slip, coated wood
antideslizante
antidérapant



	cm	↑ cm	€
00524	43,5 x 31,5	1,5	19,00
00525	52,0 x 39,0	1,5	24,60
00526	60,5 x 42,5	1,5	30,00



Serviertablett „NON-SLIP“

tray non-slip
bandeja antideslizante
plateau antiglisse

rutschfeste Oberfläche

non-slip surface
superficie antideslizante
surface antidérapante



	cm	↑ cm	GN	Farbe / Colour	€
00502	53 x 32,5	1,5	1/1	■	25,00
00508	46 x 36,0	2		■	22,90

FAST FOOD TRAYS



00535



00536



00537



00538



00534



00539

Fast Food-Tablett
 snack tray
 bandeja autoservicio y snacks
 plateau self-service et snacks



	cm	↑ cm	GN	Farbe / Colour	€
00530	35 x 27,0	2			3,70
00535	41 x 30,5	2			5,00
00540	45 x 35,5	2			6,20
00552	53 x 32,5	2	1/1		7,60

	cm	↑ cm	GN	Farbe / Colour	€
00531	35 x 27,0	2			3,70
00536	41 x 30,5	2			5,00
00541	45 x 35,5	2			6,20
00553	53 x 32,5	2	1/1		7,60

	cm	↑ cm	GN	Farbe / Colour	€
00532	35 x 27,0	2			3,70
00537	41 x 30,5	2			5,00
00542	45 x 35,5	2			6,20
00554	53 x 32,5	2	1/1		7,60

	cm	↑ cm	GN	Farbe / Colour	€
00533	35 x 27,0	2			3,70
00538	41 x 30,5	2			5,00
00543	45 x 35,5	2			6,20
00555	53 x 32,5	2	1/1		7,60

	cm	↑ cm	Farbe / Colour	€
00534	35 x 27,0	2		3,70

	cm	↑ cm	Farbe / Colour	€
00539	35 x 27,0	2		3,70



stapelbar
 stackable



Rechnungstablett

bill presenter
porta cuenta
porte-addition

mit Klemme für Rechnung
with clip for bill
con clip para la nota
avec clip pour la note



	cm	↑ cm	€
30108	20 x 12	1,5	2,40



Rechnungstablett

bill presenter
porta cuenta
porte-addition

mit Klemme für Rechnung
with clip for bill
con clip para la nota
avec clip pour la note



	cm	↑ cm	€
30110	17 x 11	1	6,30



Tischkrümelentferner

crumber
recogemigas
ramasse-miettes

geschliffene Edelstahlkante, matt poliert, einfache Handhabung
flat grinded stainless steel edge, matt polished, easy to handle
geschliffene Edelstahlkante, pulido mate, fácil de usar, mango hueco
geschliffene Edelstahlkante, poli mat, manche creux, simple à utiliser



	Ø cm	↑ cm	€
00581	19,5 x 4,5	1	8,00



Rezeptionsglocke

ring bell
timbre
sonnette



	Ø cm	↑ cm	Farbe / Colour	€
71400	8,5	6,0	■	6,20
71433	10,0	6,5	■	8,20

ASHTRAYS



Windaschenbecher

ashtray
cenicero
cendrier

Metall verchromt, Glas gefrostet, mit Bajonettverschluss
 metal chrome plated, glass frosted, bayonet lock
 metal cromado, opaco mate, cierre de bayoneta
 métal chromé, mat, verrouillage par baïonnette

	Ø cm	↑ cm	Farbe / Colour	€
00582	9,5	8		9,40
00583	9,5	8		9,40
00584	9,5	8		9,40
00585	9,5	8		9,40



Windaschenbecher

ashtray
cenicero
cendrier

Metall verchromt, Glas gefrostet, mit Bajonettverschluss
 metal chrome plated, glass frosted, bayonet lock
 metal cromado, opaco mate, cierre de bayoneta
 métal chromé, mat, verrouillage par baïonnette

	Ø cm	↑ cm	Farbe / Colour	€
00560	9,5	8		9,40
00561	9,5	8		9,40
00562	9,5	8		9,40
00563	9,5	8		9,40
00564	9,5	8		9,40





Drehaschenbecher „PUSH“

ashtray
cenicero
cendrier



Deckel mit Drehmechanismus, mit Bajonettverschluss
with rotary button, bayonet lock
con botón giratorio, cierre de bayoneta
tourne par pression sur le bouton, verrouillage par baïonnette

	Ø cm	↑ cm	€
00568	9,5	11	11,00



Drehmechanismus
rotary button



Drehaschenbecher „KLASSIKER“

ashtray
cenicero
cendrier giratoire



Deckel mit Drehmechanismus
with rotary button
con botón giratorio
tourne par pression sur le bouton

	Ø cm	↑ cm	Farbe / Colour	€
00054	13,0	10,5		9,40
00056	10,5	11		8,40

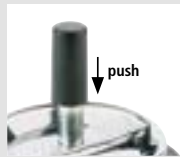

Drehmechanismus
rotary button



Windaschenbecher

ashtray
cenicero
cendrier



Deckel hochglanzpoliert, Behälter matt poliert, mit Windschutzdeckel
lid mirror polished, container matt polished, with windcover
con tapa antiviento pulida brillante y contenedor pulido efecto pulido mate
couverture anti-vent brillant, corps poli mat poli maté

	Ø cm	↑ cm	€
00052	12	5,5	9,80



Klappmechanismus
rotary button



Windaschenbecher „ELEMENT“

ashtray
cenicero
cendrier



möbelschonende Unterseite
non-scratching undersurface
base anti rayaduras
avec revêtement antirayures

	Ø cm	↑ cm	€
00570	10,5	5,0	7,80



00091

Windaschenbecher

ashtray
cenicero
cendrier

matt poliert, mit Windschutzdeckel

matt polished, with windcover

pulido mate apilable, tapa para el viento

poli mat, empilable, couvercle anti-vent



	Ø cm	↑ cm		€
00090	10	4,5		8,00
00091	12	4,5		8,80

stapelbar
stackable

83488

Windaschenbecher

ashtray
cenicero
cendrier

	Ø cm	↑ cm	Farbe / Colour	€
83488	11,5	5	white	6,20
83489	11,5	5	black	6,00



83611

Windaschenbecher

ashtray
cenicero
cendrier

	Ø cm	↑ cm	Farbe / Colour	€
83610	10	4,0	white	5,00
83612	12	4,5	white	5,40
83611	10	4,0	black	5,00
83613	12	4,5	black	5,40



Windaschenbecher „SMOKY“

ashtray
cenicero
cendrier

mit abnehmbarem Deckel

with removable lid

con tapa extraíble

avec couvercle amovible



	Ø cm	↑ cm	Farbe / Colour	€
00586	8,5	11,5	schwarz / black	5,00
00578	8,5	11,5	verzinkt / galvanised	6,00

ASHTRAYS



Aschenbecher

ashtray
cenicero
cendrier



	Ø cm	↑ cm	Farbe / Colour	€
83616	9,5	4,5	■	2,80



Aschenbecher

ashtray
cenicero
cendrier



matt poliert, hochwertige schwere Ausführung

matt polished, high quality, heavy gauge
pulido pulido mate, alta calidad, apilable
poli mat, empilable, belle qualité

	Ø cm	↑ cm	€
00048	8	3	8,40
00050	10	3	10,00



Aschenbecher, 3er Set

ashtray, 3 pcs.
set de 3 cenicero
set de 3 cendriers



	Ø cm	↑ cm	Farbe / Colour	pcs.	€ / set
00576	8	3	■	3	2,80



Standascher „DIABOLO“

standing ashtray
cenicero de pie
cendrier sur pied



für den Innen- und Außenbereich, inklusive 1,5 kg Sand, eine Ascheschale für die Sandbefüllung und ein Metallsieb

for in,- outdoor use, included a bag of sand and a metal sieve

uso en interior o exterior, incluye una bolsa de arena y embudo de metal

usage en intérieur ou extérieur, livré avec un sac de sable et entonnoir métal

	Ø cm	↑ cm	€
00574	40	60	76,00



vielseitig nutzbar
versatile



zerlegbar und stapelbar
dismountable and stackable



Tretbeutelhalter

pedal bin
soporte a pedal
poubelle à pédale

geeignet für Müllbeutel bis 120 ltr., 110 x 70 cm

suitable for bags up to 120 ltr., 110 x 70 cm

apto para bolsas hasta 120 l., medidas sin bolsa 110 x 70 cm

apte pour sacs de 120 l., dim. sans sac 110 x 70 cm

	cm	↑ cm	€
00580	59 x 43	96	142,00



Gummilippe 55 cm breit, Abstand zwischen Gummilippe und Bodenblech 82 cm



leichte Bedienung, Trittmechanismus
easy handling, step on bin



2 Lenkrollen mit Feststellern
2 wheels with brakes

NEW

Der nachhaltige Mehrwegbecher – made in Germany



eco-friendly



Das Ribbendesign isoliert die Hitze – kein „Verbrennen“ der Finger möglich

The rib design insulates the heat - no „burning“ of the fingers possible

Mehrwegbecher individuell mit Ihrem Logo/Namen herstellbar ab 500 Stck. – sprechen Sie uns an!

Reusable cups can be individually produced with your logo/name. From 500 pieces - please contact us!

- ✓ aufsteckbarer Deckel mit Trinköffnung
- ✓ 100% recyclebar
- ✓ spülmaschinengeeignet
- ✓ stapelbar mit und ohne Deckel
- ✓ schwappsicher

- clip-on lid with drinking opening
- 100% recyclable
- dishwasher safe
- stackable with and without lid
- slosh-/leak-proof

NEW



To Go Mehrwegbecher

To Go reusable cup
vaso reutilizable To Go
tasse réutilisable To Go
Becher (ohne Deckel)
cup (without cover)
vaso (sin tapa)
tasse (sans couvercle)



	Ø cm	↑ cm	ltr.	Farbe / Colour	VE / unit	€/ pc.
66910	8,5	13,5	0,4		48	2,00
66911	8,5	13,5	0,4		48	2,00
66912	8,5	13,5	0,4		48	2,00
66913	8,5	13,5	0,4		48	2,00

Deckel / cover / tapa / couvercle

	Ø cm	↑ cm	Farbe / Colour	VE / unit	€/ pc.
66914	8,5	2,5		48	1,00
66915	8,5	2,5		48	1,00
66916	8,5	2,5		48	1,00
66917	8,5	2,5		48	1,00

DRINKING BOTTLE



Trinkflasche drinking bottle cantimplora gourde

EDELSTAHL
STAINLESS
INOX
18/8

HOLZ
WOOD

die doppelwandige Vakuumflasche aus Edelstahl hält Heißes 12 Stunden heiß und Kaltes 24 Stunden kalt, 100% auslaufsicher

the double-walled stainless steel vacuum bottle keeps hot drinks hot for 12 hours and cold drinks cold for 24 hours, 100% leak proof

la cantimplora al vacío de acero inoxidable de doble pared mantiene las bebidas calientes durante 12 horas y las frías durante 24 horas, 100% transporte sin salpicaduras

la gourde à vide en acier inoxydable à double paroi permet de conserver les boissons chaudes pendant 12 heures et les boissons froides pendant 24 heures, 100% transport sans éclaboussures

	Ø cm	↑ cm	ltr.	€
66905	7,5	24,5	0,5	11,00



Trinkflasche drinking bottle cantimplora gourde

EDELSTAHL
STAINLESS
INOX
18/8

HOLZ
WOOD

die doppelwandige Vakuumflasche aus Edelstahl hält Heißes 12 Stunden heiß und Kaltes 24 Stunden kalt, 100% auslaufsicher

the double-walled stainless steel vacuum bottle keeps hot drinks hot for 12 hours and cold drinks cold for 24 hours, 100% leak proof

la cantimplora al vacío de acero inoxidable de doble pared mantiene las bebidas calientes durante 12 horas y las frías durante 24 horas, 100% transporte sin salpicaduras

la gourde à vide en acier inoxydable à double paroi permet de conserver les boissons chaudes pendant 12 heures et les boissons froides pendant 24 heures, 100% transport sans éclaboussures

	Ø cm	↑ cm	ltr.	€
66906	7,5	29,5	0,75	13,60



...immer dabei



mit Schraubverschluss
with screw cap

inkl. Ersatzdichtung
incl. spare gasket

500 ml

750 ml

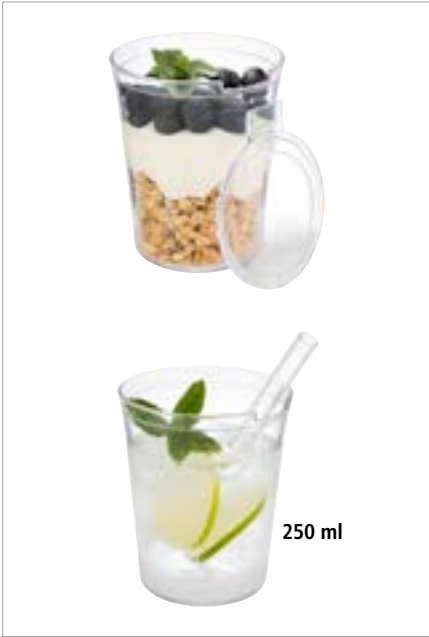

Becher Set „SUPER CUP“, 8er Set

barrel mug set, 8 pcs.
vasos, set de 8
gobelets, set de 8

Set bestehend aus 8 Bechern + 8 Deckeln
set consists of 8 barrel mugs + 8 lids
set compuesto por 8 vasos + 8 tapas
set composé de 8 gobelets + 8 couvercles



IDEAL
FÜR
„TAKE AWAY“

	Ø cm	↑ cm	ltr.	pcs.	€/ set
10506	8	10	0,25	8	19,00



mit Stapelnocke
with stacking cam



rutschfester Deckel
non-slip lid



Servierbeispiel Deckel
presentation example cover



Lunchbag, 2er Set

lunch bag, 2 pcs.
bolsa de almuerzo, set de 2
sac à lunch, set de 2

70% Naturfaser und 30% Kunstharz, mit Klettverschluss

70% natural fibre and 30% synthetic resin, with velcro fastener

70% fibra natural y 30% resina sintética, con cierre de velcro

70% de fibres naturelles et 30% de résine synthétique, avec fermeture velcro



	cm	↑ cm	pcs.	€/ set
30357	16 x 10	32	2	17,00
30358	25 x 15	30	2	22,00



Präsentationsmöglichkeit
presentation example



Lunchbox



Lunchbox „M“

lunchbox
fiambrella
boîte à lunch



Edelstahlbox mit Silikondichtung inkl. Trennsteg, auslaufsicher

stainless steel box with silicone seal incl. divider, leak-proof

caja de acero inoxidable con junta de silicona y divisor extraíble, transporte sin salpicaduras

boîte en acier inox avec joint en silicone et diviseur amovible, transport sans éclaboussures

	cm	↑ cm	ltr.	€
66900	18,5 x 13,5	6,5	0,8	14,50



Lunchbox „L“

lunchbox
fiambrella
boîte à lunch



Edelstahlbox mit Silikondichtung inkl. Trennsteg, auslaufsicher

stainless steel box with silicone seal incl. divider, leak-proof

caja de acero inoxidable con junta de silicona y divisor extraíble, transporte sin salpicaduras

boîte en acier inox avec joint en silicone et diviseur amovible, transport sans éclaboussures

	cm	↑ cm	ltr.	€
66901	20,5 x 14,5	6,5	1,1	17,00



Lunchbox „XL“

lunchbox
fiambrella
boîte à lunch



Edelstahlbox mit Silikondichtung inkl. Trennsteg, auslaufsicher

stainless steel box with silicone seal incl. divider, leak-proof

caja de acero inoxidable con junta de silicona y divisor extraíble, transporte sin salpicaduras

boîte en acier inox avec joint en silicone et diviseur amovible, transport sans éclaboussures

	cm	↑ cm	ltr.	€
66902	22,5 x 16,5	6,5	1,4	19,50



mit zwei Verschlüssen
with 2 clasps

66900

0,8 ltr.



66901

1,1 ltr.



66902

1,4 ltr.



herausnehmbarer Trennsteg
removable divider



auslaufsicher | leak-proof







Servier- & Küchenhelfer

serving items & kitchentools

herramientas de cocina

outils de cuisine

BANQUET.....	438
PROFI.....	440
CLASSIC.....	441
STOP TOOLS.....	442
POLYAMIDE KITCHENTOOLS.....	444
TONGS.....	446
TWEEZERS.....	452
DELICATESSEN SPOONS.....	453
SPOONS WOOD.....	454
ORANGE.....	456
BLUE.....	459
CUTTERS WHISKS.....	462
STRAINERS.....	463
CONFECTIONARY KITCHENTOOLS.....	466
MEASURING CUPS.....	467
STIRRING CUPS MOUSSE RINGS.....	468
DARIEL MOULDS CAKE SETTING RINGS DISPLAY TRAYS...	469
BUCKETS SCOOPS.....	470
FUNNELS.....	471
SQUEEZERS BRUSHES BREADING SETS.....	472
BILL RAILS KNIFE RACKS TEAR-OFF-DISPENSERS.....	473
KITCHEN TOOLS.....	474
SQUEEZE BOTTLES.....	475
DISPENSERS EGG BOXES.....	477
PIZZA.....	478

BANQUET



Die Vorlegeserie BANQUET ist die passende Ergänzung zum Servieren am Buffet. Durch die mattierte Oberfläche und das gebogene Griffende wird BANQUET praktischen und optischen Ansprüchen gerecht.

The series BANQUET is the perfect addition for serving at the buffet. Due to the matt surface and the curved handle, BANQUET meets practical and optical requirements.

La serie BANQUET es la adición perfecta para servir en el buffet. Debido a la superficie mate y al mango curvado, BANQUET cumple con requisitos prácticos y ópticos.

La série BANQUET est l'ajout parfait pour servir au buffet. Grâce à la surface mate et la poignée incurvée, BANQUET répond aux exigences pratiques et optiques.



Salat- / Servierlöffel „BANQUET“ salad spoon / serving spoon cuchara para ensalada / cuchara de servicio cuillère à salade / cuillère de service



	cm	Griff / handle cm	€
00588	6 x 5	17	5,60
00590	7,5 x 6	21	8,00



Salatgabel „BANQUET“ salad fork tenedor de servicio para ensalada fourchette de service pour la salade



	cm	Griff / handle cm	€
00589	6 x 5	17	5,60
00591	7,5 x 6	21	8,00

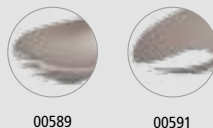

Schöpflöffel „BANQUET“ ladle cucharón louche



	cm	Griff / handle cm	€
00595	8,5 x 7,5	24	16,00



Chafing Dish Löffel „BANQUET“

serving spoon
cuchara para servir
cuillère de service



	cm	Griff / handle cm		€
00592	11 x 6,5	24		9,40
00593	11 x 6,5	24	geschlitzt / slotted	9,00



00593



Dressinglöffel „BANQUET“

dressing spoon
cuchara de aliño
cuillère à vinaigrette



	cm	Griff / handle cm		€
00594	6 x 4	30		11,50



Pfannenwender „BANQUET“

turner
espátula
spatule



	cm	Griff / handle cm		€
00587	10 x 7,5	21		9,00



Fleischgabel „BANQUET“

meat fork
tenedor de carne
fourchette à viande



	cm	Griff / handle cm		€
00596	8 x 2,5	13		4,90



Serviergabel „BANQUET“

fork
tenedor de servicio
fourchette de service



	cm	Griff / handle cm		€
00597	9 x 4	21		8,40



Tortenheber „BANQUET“

cake lifter
pala de tartas
pelle à gâteau
eine Kante gezahnt
one edge serrated
un borde serrado
denté sur un côté



	cm	Griff / handle cm		€
00598	14 x 6	13		7,00



Schöpflöffel „PROFI“

ladle
cacillo
louche



	Ø cm	Griff / handle cm	ltr.	€
00711	6	28	0,050	12,20
00712	7	30	0,080	12,60
00713	8	32	0,125	13,60
00714	9	33	0,150	15,60
00715	10	35	0,250	16,30
00716	11	36	0,300	16,90



Schaumlöffel „PROFI“

skimmer
espumadera
écumoire



	Ø cm	Griff / handle cm	€
00721	10	34	13,20
00722	12	37	14,10
00723	14	40	15,40



Wender „PROFI“

turner
espátula
spatule



	cm	Griff / handle cm	€
00730	10 x 11,5	38	15,40



Servierlöffel „PROFI“

serving spoon
cuchara de servicio
cuillère de service



	cm	Griff / handle cm		€
00671	11 x 7	29	geschlitzt / slotted	9,20
00672	11 x 7	29		9,20



Spaghettilöffel „PROFI“

spaghetti spoon
cuchara de espaguetis
cuillère à spaghettis



	cm	Griff / handle cm	€
00673	10 x 7	29	9,90



Servierlöffel „CLASSIC“

serving spoon
cuchara de servicio
cuillère de service



hochglanzpoliert, perforiert, Löcher Ø 4 mm, ergonomisch profilierter Hohl-Griff
mirror polished, perforated, holes Ø 4 mm, ergonomic designed handle
pulido brillante agujeros de Ø 4 mm, asa ergonómica
brillant, trous Ø 4 mm, manche ergonomique

	cm	Griff / handle cm	€
75903	9,5 x 7	23,5	9,30



Salatlöffel „CLASSIC“

salad spoon
cuchara para ensalada
cuillère à salade



hochglanzpoliert, ergonomisch profilierter Hohl-Griff
mirror polished, ergonomic designed handle
pulido brillante, asa ergonómica
poli brillant, manche ergonomique

	cm	Griff / handle cm	€
75902	8 x 6	21,5	9,30
75904	9,5 x 7	23,5	9,30



Suppenkelle „CLASSIC“

soup ladle
cucharón de sopa
louche de service



hochglanzpoliert, ergonomisch profilierter Hohl-Griff
mirror polished, ergonomic designed handle
pulido brillante, asa ergonómica
poli brillant, manche ergonomique

	Ø cm	Griff / handle cm	litr.	€
75907	7	23	0,06	10,00
75908	9	24	0,1	11,00



Saucengießlöffel „CLASSIC“

sauce / gravy ladle
cucharón de salsa
cuillère à sauce



hochglanzpoliert, ergonomisch profilierter Hohl-Griff, fugenlos
mirror polished, ergonomic designed handle, seamless
pulido brillante, asa ergonómica, sin soldadura
poli brillant, manche ergonomique, monobloc (sans soudure)

	cm	Griff / handle cm	litr.	€
75906	7 x 5,5	22	0,02	8,70



Tortenheber „CLASSIC“

cake lifter
pala de tartas
pelle à gâteau



hochglanzpoliert, mit einer gezahnten Kante, ergonomisch profilierter Hohl-Griff
mirror polished, one edge serrated, ergonomic designed handle
pulido brillante, canto dentado, mango ergonómico
poli brillant, bord microdenté, manche ergonomique

	cm	Griff / handle cm	€
75900	8 x 5	10,5	8,60
75912	5 x 1	12	10,30

STOP-TOOLS

Die STOP-Funktion verhindert, dass Gabel oder Löffel in das Gefäß rutschen.

The smart STOP-function prevent forks and spoon not to slip into the vessel.

La función STOP evita que los cubiertos se caigan dentro del recipiente.

La fonction STOP empêche les couverts de glisser dans le récipient.



STOP
Funktion



Servierlöffel

serving spoon
cuchara para servir
cuillère à servir

Materialdicke 2,5 mm, ergonomischer, rutschfester Griff
material thickness: 2,5 mm, ergonomic antislip handle
grosor: 2,5 mm, mango ergonómico antideslizante
épaisseur : 2,5 mm, poignée ergonomique antidérapante



	cm	Griff / handle cm	€
00834	10 x 7,5	17	11,50



Servierlöffel geschlitzt

slotted spoon
cuchara para servir ranurada
cuillère à servir rainurée

Materialdicke 2,5 mm, ergonomischer, rutschfester Griff
material thickness: 2,5 mm, ergonomic antislip handle
grosor: 2,5 mm, mango ergonómico antideslizante
épaisseur : 2,5 mm, poignée ergonomique antidérapante



	cm	Griff / handle cm	€
00833	10 x 7,5	17	11,50



Schöpflöffel

ladle
cucharón
louche

Materialdicke 2,5 mm, ergonomischer, rutschfester Griff
material thickness: 2,5 mm, ergonomic antislip handle
grosor: 2,5 mm, mango ergonómico antideslizante
épaisseur : 2,5 mm, poignée ergonomique antidérapante



	Ø cm	Griff / handle cm	€
00832	9	17	12,50



Fleischgabel

meat fork
tenedor de carne
fourchette à viande

Materialdicke 2,5 mm, ergonomischer, rutschfester Griff
material thickness: 2,5 mm, ergonomic antislip handle
grosor: 2,5 mm, mango ergonómico antideslizante
épaisseur : 2,5 mm, poignée ergonomique antidérapante



	cm	Griff / handle cm	€
00831	10,5 x 4	17	11,50



Servierlöffel geschlitzt
 slotted spoon
 cuchara para servir ranurada
 cuillère à servir rainurée
ergonomischer, rutschfester Griff
 ergonomic antislip handle
 mango ergonómico antideslizante
 poignée ergonomique antidérapante



	cm	Griff / handle cm	€
00664	11 x 7	25	6,80



Servierlöffel
 serving spoon
 cuchara para servir
 cuillère à servir
ergonomischer, rutschfester Griff
 ergonomic antislip handle
 mango ergonómico antideslizante
 poignée ergonomique antidérapante



	cm	Griff / handle cm	€
00662	11 x 7	25	6,80



Schöpföffel
 ladle
 cucharón
 louche
ergonomischer, rutschfester Griff
 ergonomic antislip handle
 mango ergonómico antideslizante
 poignée ergonomique antidérapante



	cm	Griff / handle cm	ltr.	€
00670	9 x 8	25	0,10	7,50



Wender
 turner
 espátula
 spatule
ergonomischer, rutschfester Griff
 ergonomic antislip handle
 mango ergonómico antideslizante
 poignée ergonomique antidérapante



	cm	Griff / handle cm	€
00668	10 x 8	25	7,50



Fleischgabel
 meat fork
 tenedor de carne
 fourchette à viande
ergonomischer, rutschfester Griff
 ergonomic antislip handle
 mango ergonómico antideslizante
 poignée ergonomique antidérapante



	cm	Griff / handle cm	€
00666	10 x 3,5	25	6,80

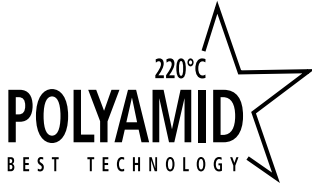

Das Profimaterial Polyamid besteht aus Nylon und Fiberglas. Hitzebeständig bis 220°C, extra hochwertige Profi-Qualität, gut geeignet für antihafbeschichtete Pfannen, ergonomischer Griff.

Polyamide is made of nylon and fiberglass. Heat-resistant up to 220°C, extra high quality, perfect for non-stick-coated pots and pans, ergonomic handle.

Poliamide de nylon y fibra de vidrio. Brevemente al calor hasta 220°, calta calidad profesional, ideal para sartenes antiadherentes, mango ergonómico.

Polyamide de nylon et fibre de verre, haute résistance brièvement à la chaleur jusque 220°C, qualité professionnelle, idéal pour les poêles antiadhérentes, manche ergonomique.



Bratenwender
turner
espátula
spatule



	cm	Griff / handle cm	€
00603	11 x 9,5	23	6,70



Pfannenwender
turner
espátula
spatule



	cm	Griff / handle cm	€
00600	11,5 x 9,5	23	6,60



Pfannenwender
turner
espátula
spatule



	cm	Griff / handle cm	€
00604	15 x 7,5	15	4,70



Pfannenwender
turner
espátula
spatule



	cm	Griff / handle cm	€
88642	13,5 x 9	18	4,80



Pfannenwender
turner
espátula
spatule



	cm	Griff / handle cm	€
88640	13 x 6,5	15	4,70



Servierlöffel
 serving spoon
 cuchara de servicio
 cuillère de service



	cm	Griff / handle cm		€
88608	12 x 7	23		6,60
00607	12 x 7	23	perforiert	6,20



Schaumlöffel
 skimmer
 espumadera
 écumoire



	Ø cm	Griff / handle cm		€
00602	11,5	23		6,70



Schöpflöffel
 ladle
 cucharón
 louche



	Ø cm	Griff / handle cm	ltr.	€
00606	9	23	0,1	6,90



Toastzange
 sandwich tongs
 pinzas para sandwich
 pince à toasts



	cm	Griff / handle cm		€
00601	11 x 8	18		8,50



Salatzange
 salad tongs
 pinzas para ensalada
 pince à salade



	cm	Griff / handle cm		€
00605	10 x 6	23		6,90



Spaghettizange
 spaghetti tongs
 pinzas para espaguetis
 pince à spaghettis



	cm	Griff / handle cm		€
88637	9 x 9	15		6,70



Salatzange „TIDLOS“

salad tong
pinza ensalada
pince à salade

hochglanzpoliert, einseitig geschlitzt
mirror polished, slotted on one side
pulido brillante, agujereada en un lado
poli brillant, perforée d'un seul côté



	cm	→ cm	€
75842	5 x 2	22	6,20



Pastazange „TIDLOS“

pasta tongs
pinza espaguetis
pince à spaghettis

hochglanzpoliert, beidseitig geschlitzt
mirror polished, slotted on both side
pulido brillante, agujereada en 2 lados
poli brillant, perforéedes 2 côtés



	cm	→ cm	€
75843	8 x 5,5	22,5	6,20



Spargelzange „TIDLOS“

asparagus tongs
pinzas para espárragos
pince à asperges

hochglanzpoliert / mirror polished / pulido brillante / poli brillant



	cm	→ cm	€
75844	7 x 11	24,5	6,90



Gebäckzange „TIDLOS“

pastry tongs
pinza para pasteles
pince à gâteaux

hochglanzpoliert / mirror polished / pulido brillante / poli brillant



	cm	→ cm	€
75840	6,5 x 4,5	21	4,40



Servierzange „TIDLOS“

serving tongs
pinza universal
pince universelle

hochglanzpoliert / mirror polished / pulido brillante / poli brillant



	cm	→ cm	€
75841	7 x 4,5	21	5,20



Salatzange

salad serving tong
pinza de ensalada
pinçe à servir la salade

hochglanzpoliert, einfache Handhabung

mirror polished, convenient handling
pulido brillante, manejo cómodo
poli brillant, manipulation aisée



	cm	→ cm	€
00685	7,0 x 4,5	25	16,40



Universalzange

all - purpose tong
pinzas multiusos
pinçe multi-usages

hochglanzpoliert, einfache Handhabung

mirror polished, convenient handling
pulido brillante, manejo cómodo
poli brillant, manipulation aisée



	cm	→ cm	€
00688	7,0 x 4,5	25	16,40



Brot- und Gebäckzange

bread and pastry tong
pinza para pan y bollería
pinçe à pain ou viennoiseries

hochglanzpoliert, einfache Handhabung

mirror polished, convenient handling
pulido brillante, manejo cómodo
poli brillant, manipulation aisée



	cm	→ cm	€
00686	7,0 x 4,5	25	16,40



Brot- und Gebäckzange

bread and pastry tong
pinza para pan y bollería
pinçe à pain ou viennoiseries

hochglanzpoliert, einfache Handhabung

mirror polished, convenient handling
pulido brillante, manejo cómodo
poli brillant, manipulation aisée



	cm	→ cm	€
00687	7,0 x 4,5	25	16,40



Universalzange
all-purpose tong
pinza universal
pince universelle



	cm	→ cm	Farbe / Colour	€
75825	7 x 5	22,5	vintage-look	10,90
75830	7 x 5	25	mirror polished	10,80
75831	7 x 5	25	gold-look	13,10
75832	7 x 5	25	copper-look	13,10



Universalzange
all-purpose tong
pinza universal
pince universelle



hochglanzpoliert, mit Befestigungsclip
mirror polished, with fastening clip
pulido brillante, con clip de fijación
poli brillant, avec clip de fixation

	→ cm	Farbe / Colour	€
75850	19,5	mirror polished	4,20
75851	19,5	copper-look	4,60
75852	19,5	gunmetal-look	4,60



Zange kann an einer Schale befestigt werden
tongs can be attached to a bowl



Eiszange
ice tongs
pinzas para hielo
pince de la glace



hochglanzpoliert, mit Befestigungsclip
mirror polished, with fastening clip
pulido brillante, con clip de fijación
poli brillant, avec clip de fixation

	→ cm	Farbe / Colour	€
75853	20	mirror polished	4,20
75854	20	copper-look	4,60
75855	20	gunmetal-look	4,60

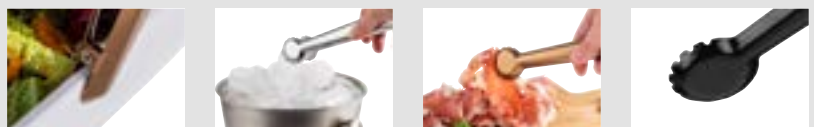

Zange kann an einer Schale befestigt werden
tongs can be attached to a bowl



Salatzange

salad tong
pinza ensalada
pince à salade



hochglanzpoliert, beidseitig geschlitzt / mirror polished, slotted on both side
pulido brillante, agujereada en 2 lados / poli brillant, perforéedes 2 côtés

	cm	→ cm	€
75801	5 x 2	24	6,30



Universalzange

all-purpose tong
pinza universal
pince universelle



Edelstahl, Antik-Edelstahl-Look / Vintage-Look

stainless steel, stainless antique look
acero inoxidable, acero estilo antiguo
acier inox, acier style antique

	cm	→ cm	Farbe / Colour	€
75823	5,5 x 5,0	20,0	vintage-look	8,00
75824	7,0 x 5,0	22,5	vintage-look	9,00



Vorspeisenzange „BANQUET“

appetizer tong
pinza para aperitivos
pince à apéritif



Vorderteil poliert, Stiel mattiert

front part: high-shiny, handle: matt-finish
parte delantera pulida, asa mate
partie avant polie, poignée matte

	cm	→ cm	€
75822	4,5 x 3,5	20	8,90



ideal für Vorspeisen
ideal for starters



Spaghettizange

spaghetti tong
pinza espaguetis
pince à spaghettis



hochglanzpoliert, fugenlos

mirror polished, seamless
pulido brillante, sin soldaduras
poli brillant, monobloc

	cm	→ cm	€
75810	6 x 3	19	4,80



Aufschnitt- / Allzweckzange

sausage tong
pinza salchichas
pince à saucisses

hochglanzpoliert, fugenlos
mirror polished, seamless
pulido brillante, sin soldadura
poli brillant, monobloc



	cm	→ cm	€
75806	3 x 2,5	16	4,00



Allzweckzange

multipurpose tong
pinza multi-usos
pince universelle multi-usages

hochglänzend, mit Feder und Verschlusschieber, dekorative Greiferform
mirror polished, with spring and retaining clip, decorative gripper form
pulido brillante, con muelle y cierre deslizando, gancho con forma decorativa
poli brillant, avec mécanisme de verrouillage, forme de pince décorative



	cm	→ cm	€
88643	4 x 3	24	3,70
88644	4 x 3	30	4,50
88645	4 x 3	40	4,90



Universalzange

all - purpose tong
pinza universal
pince universelle

hochglanzpoliert, einseitig geschlitzt
mirror polished, slotted on one side
pulido brillante, agujereada en un lado
poli brillant, perforée d'un seul côté



	cm	→ cm	€
75800	5 x 2	24	5,00



Gebäckzange

pastry tong
pinza para pasteles
pince à gâteaux

hochglanzpoliert, fugenlos, extra schwere Qualität
mirror polished, seamless, extra heavy gauge
pulido brillante, sin soldadura, alta calidad, resistente
poli brillant, monobloc, qualité extra, robuste



	cm	→ cm	€
75807	8,5 x 4	27,5	9,70

**Gebäck- / Tortenzange**

pastry tong
pinza para pasteles
pince à gâteaux

hochglanzpoliert, fugenlos
mirror polished, seamless
pulido brillante, sin soldadura
poli brillant, monobloc



	cm	→ cm	€
75803	7 x 3,5	17,5	5,40

**Gebäckzange**

pastry tong
pinza para pasteles
pince à gâteaux

hochglanzpoliert, perforiert
mirror polished, perforated
pulido brillante, perforado
poli brillant, perforée



	cm	→ cm	€
75804	6,5 x 3	19,5	8,40

**Eisportionierer**

ice cream scoop
cuchara para helado
cuillère à glace

hochglanzpoliert, mit Edelstahlfeder (physikalisch bedingt nicht korrosionsbeständig)
mirror polished, spring steel, spring is not stainless
pulido brillante, muelle de acero especial, no resistente al óxido
poli brillant, ressort acier spécial, non résistant à l'oxydation

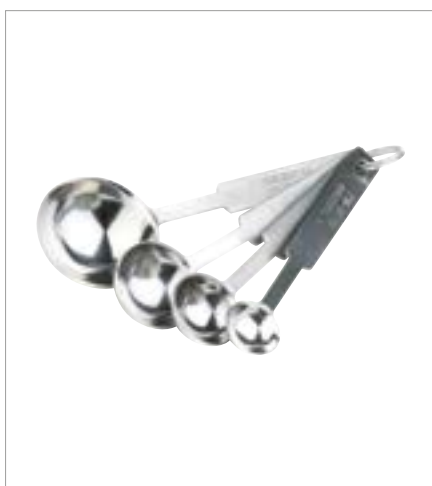

	Ø cm	→ cm	ltr.	€
71006	6,5	23,5	1/12	11,60
71005	6,0	22,5	1/16	11,60
71004	5,5	22,0	1/20	11,60
71003	5,0	22,0	1/24	11,60
71002	5,0	21,5	1/30	11,60
71001	4,5	21,0	1/36	11,60

**Messlöffelsatz**

set measuring spoon
juego de cucharas medidoras
jeu de cuillère à mesure

Löffel hochglanzpoliert, Stiele matt poliert, Skalierung:
1 Esslöffel, 1 Teelöffel, 1/2 Teelöffel, 1/4 Teelöffel

bowl mirror polished, handles matt polished, measures:
table spoon, tea spoon, 1/2 tea spoon, 1/4 tea spoon

bol medidor brillante, mango mate medidas:

1 cuchara de sopa, 1 cuchara de té, 1/2 cuchara de té, 1/4 cuchara de té

corps brillant, manche mat, mesures:

1 cuillerée à soupe, 1 cuillerée à thé, 1/2 cuillère à thé, 1/4 de cuillère à thé



	cm	€
75600	14 x 4,5	6,70

TWEEZERS



Pinzettenzange

fine tong / tweezer
pinza de emplatar
pince à dresser

hochglanzpoliert, geriffelte Grifffläche, schwere Qualität

mirror polished, ribbed handle, heavy gauge

pulido brillante, mango cómodo ranurado, alta calidad

poli brillant, manche rainuré antiglisse, qualité extra



	→ cm	€
75820	16	6,60



Pinzettenzange

fine tong / tweezer
pinza de emplatar
pince à dresser

hochglanzpoliert, geriffelte Grifffläche, schwere Qualität

mirror polished, ribbed handle, heavy gauge

pulido brillante, mango cómodo ranurado, alta calidad

poli brillant, manche rainuré antiglisse, qualité extra



	→ cm	€
75821	30	9,90



Pinzettenzange

fine tong / tweezer
pinza de emplatar
pince à dresser

hochglanzpoliert, geriffelte Grifffläche, schwere Qualität

mirror polished, ribbed handle, heavy gauge

pulido brillante, mango cómodo ranurado, alta calidad

poli brillant, manche rainuré antiglisse, qualité extra



	→ cm	€
75809	30	8,40



Pinzettenzange

fine tong / tweezer
pinza de emplatar
pince à dresser

hochglanzpoliert, geriffelte Grifffläche, abgerundete Spitzen vorne, schwere Qualität

mirror polished, ribbed handle, rounded on the tops, heavy gauge

pulido brillante, mango cómodo ranurado, alta calidad, puntas redondeadas

poli brillant, manche rainuré antiglisse, qualité extra, pointes arrondies



	→ cm	€
75808	14,5	5,50



Gourmetlöffel/-gabel, 6er Set

tapas spoon / fork, 6 pcs.
cuchara / tenedor de tapas, set de 6
cuillère / fourchette à tapas, set de 6

kann als Löffel oder Gabel verwendet werden

can be used as a spoon or fork
puede utilizarse como cuchara o tenedor
peut être utilisé comme une cuillère ou une fourchette



	→ cm	pcs.	€ / set
00699	10	6	9,00



Feinkost- / Olivenlöffel, 6er Set

delicatessen / olives spoon, 6 pcs.
cuchara gourmet / para aceitunas, set de 6
cuillère gourmet / à olives, set de 6

gelocht
perforated
perforadas
perforées



	cm	→ cm	pcs.	Farbe / Colour	€ / set
88598	6 x 9	27	6	■	12,00



Feinkostlöffel, 6er Set

delicatessen spoon, 6 pcs.
cuchara gourmet, set de 6
cuillère gourmet, set de 6

aus Kunststoff
plastic
plástico
plastique



	Ø cm	→ cm	pcs.	Farbe / Colour	€ / set
88627	6	23	6	■	9,40
88628	6	23	6	■	9,40



Dressinglöffel

dressing spoon
cuchara de aliño
cuillère à sauce

aus Kunststoff
plastic
plástico
plastique



	Ø cm	→ cm	ltr.	Farbe / Colour	€
88636	6	34	0,05	■	3,70
88609	6	34	0,05	■	3,70



Salatbesteck „OLIVE“, 2er Set

spoon, 2 pcs.
cuchara, set de 2
cuillère, set de 2

aus Olivenholz
olive wood
madera de olivo
en bois d'olivier



	cm	→ cm	€ / set
00841	9,5 x 8,5	17,0	17,30
00842	7,5 x 6,0	22,5	11,00



Anwendungsbeispiel
application example



Anwendungsbeispiel
application example



Löffel „OLIVE“

spoon
cuchara
cuillère

aus Olivenholz, ideal für Reis, Gemüse...
olive wood, ideal for rice, vegetables...
madera de olivo, ideal para arroz, verduras...
en bois d'olivier, idéal pour le riz, les légumes...



	cm	→ cm	€
00840	9,5 x 8,5	17,0	16,00



Schaufel „OLIVE“

scoop
pala
pelle

aus Olivenholz, ideal für Gewürze, Körner etc.
olive wood, ideal for spices, grains etc.
madera de olivo, ideal para especias, granos etc.
en bois d'olivier, idéal pour les épices, céréales, etc.



	→ cm	€
01020	13,5	7,40





Löffel „OLIVE“, 2er Set

spoon, 2 pcs.
cuchara, set de 2
cuillère, set de 2

aus Olivenholz, ideal für Gewürze
olive wood, ideal for spices
madera de olivo, ideal para especias
en bois d'olivier, idéal pour les épices



	→ cm	pcs.	€ / set
01018	14	2	6,60



Honiglöffel „OLIVE“

honey spoon
cuchara de miel
cuillère à miel

aus Olivenholz
olive wood
madera de olivo
en bois d'olivier



	→ cm	€
01019	15	4,90



Löffel „ACACIA“

spoon
cuchara
cuillère

aus Akazienholz, ideal für Reis, Gemüse...
acacia wood, ideal for rice, vegetables...
madera de acacia, ideal para arroz, verduras...
bois d'acacia, idéal pour le riz, les légumes...



	cm	→ cm	€
00599	9 x 6,5	23,5	5,50



Schaufel

scoop
pala
pelle

aus geöltem Eichenholz, mit Kunstlederband, ideal für Gewürze, Körner etc.
made of oiled oak wood, with leatherette strap, ideal for spices, grains etc.
de madera de roble aceitada, con correa de polipiel, ideal para especias, granos etc.
en bois de chêne huilé, avec bracelet en simili-cuir, idéal pour les épices, céréales, etc.



	cm	↑ cm	€
01026	25,5 x 6	4,5	14,00



Anwendungsbeispiel
application example

ORANGE



Kugelausstecher - doppelt „ORANGE“

melon baller - double
vaciador doble de bola
moule à boule double



zum Formen von Kugeln aus Obst, Gemüse oder Butter, Edelstahl mit geschärften Rändern
to form balls out of fruits, vegetables, butter, etc., stainless steel with sharpened edge
para hacer bolas con frutas, verduras, mantequilla, etc. acero inoxidable con borde afilado
pour faire des boules de fruits, légumes, beurre, etc. inox, bord affûté

	∅ cm	→ cm	€
88810	2,2 + 2,5	16,5	7,50
88811	2,2 + 3,0	17	7,60



Fadenschneider / Zester „ORANGE“

decorator / zester
cuchillo de decoración cincelador
couteau zesteur



zum Abziehen von feinsten Schalenstreifen, ideal zum Dekorieren von Torten und Desserts
to peel off very fine stripes of paring, these stripes are ideal to decorate desserts, cakes, etc.
para pelar tiras muy finas, ideal para decorar postres, tartas, etc.
pour couper en lanières fines, idéal pour la décoration de gâteaux et desserts, etc.

	∅ cm	→ cm	€
88823	0,2 + 0,5	14,5	4,20



Ziseliermesser „ORANGE“

canele / decorating knife
cuchillo de decoración cincelador acanalado
couteau zesteur cannelé



zum Einritzen von Linien und Mustern in hartschaliges Obst und Gemüse, Edelstahl mit geschärften Rändern
to score lines or design in hard fruits and vegetables, stainless steel with sharpened edge
para dibujar líneas en frutas o verduras de piel dura, acero inoxidable con borde afilado
pour découper des lignes et motifs sur fruits et légumes à peau dure ou pour peler les zestes des citrons ou oranges, inox, bord affûté

	→ cm	€
88826	15	4,20



Sparschäler „ORANGE“

peeler
pelador
peleur



für Links- und Rechtshänder geeignet, mit zwei starren Klingen aus extra geschärftem + gehärtetem Edelstahl
useable left- and right handed, with 2 inflexible blades made out off sharpened, extra hardened stainless steel

para diestros y zurdos, con 2 cuchillas rígidas inox afiladas y muy resistentes
pour gauchers ou droitiers, 2 lames rigides affûtés en inox extra-résistant

	→ cm	€
88827	17	2,80

**Pendelschäler „ORANGE“**

swivel peeler
pelador reversible
éplucheur droitier/gaucher

für Links- und Rechtshänder, ideal für das Schälen von Tomaten, mit 2 beweglichen Klingen

suitable for right and left handed, ideal to peel tomatoes, with 2 flexibles blades

apto para diestros y zurdos, ideal para pelar tomates, con 2 hojas flexibles

pour gauchers ou droitiers, idéal pour peler les tomates, 2 lames flexibles



	→ cm	€
88850	16,5	4,60

**Cocktailmesser „ORANGE“**

bar knife
cuchillo para cóctel
couteau cocktail

mit 2 Zinken zum Aufspießen von Zitrusseiben

with 2 prongs to pick up slices of lemon

con 2 dientes para pinchar las rodajas de limón, etc.

avec 2 dents pour les rondelles de citron et autres décorations



	→ cm	€
88846	21	4,80

**Pizzateigschneider „ORANGE“**

pizza cutter
cortador de pizza
roulette à pizza

zum einfachen Zerteilen von Pizza

to cut pizza easily

para cortar pizza fácilmente

pour une coupe facile de la pizza



	∅ cm	→ cm	€
88829	6	18,5	4,80

**Pendelschäler „ORANGE“**

swivel peeler
pelador lama pivotante
peleur lame pivotante

zum schnellen und sparsamen Schälen von Obst und Gemüse, mit beweglicher Klinge

to peel fruits and vegetables with flexible blade

para pelar frutas y verduras con hoja flexible

pour couper des fruits et légumes avec lame flexible

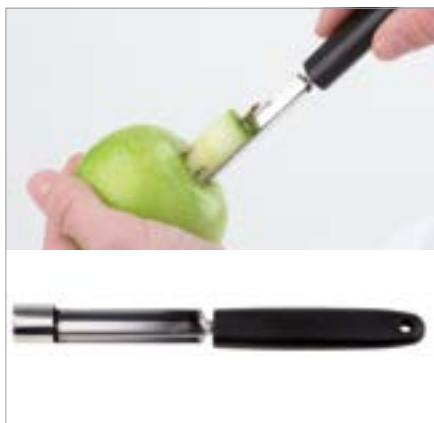

	→ cm	€
88834	17	5,20

**Apfelentkerner „ORANGE“**

apple corer
descorazonador de manzana
vide-pomme

durch leichtes Drehen kann das Kerngehäuse von Äpfeln, Birnen und anderen Früchten sorgsam herausgeholt werden, Edelstahl mit geschärften Rändern

with a light turn cores of apples, pears and other fruits

can be cut off easily, stainless steel with sharpened edge

para descorazonar muy fácilmente manzanas, peras y otras frutas

pour évider facilement les pommes, poires ou autres fruits



	∅ cm	→ cm	€
88836	2,2	21	3,30



Austernöffner „ORANGE“

oyster knife
 abre ostras
 couteau à huîtres



zum einfachen Aufbrechen von Austern, mit Fingerschutz, Edelstahl mit geschärften Rändern
 to open oysters easily, with guard, stainless steel with sharpened edge
 para abrir ostras fácilmente con protección para los dedos, acero inoxidable con punta afilada
 pour ouvrir facilement les huîtres avec protection pour les doigts, inox, pointe affûtée

	→ cm	€
88839	14,5	7,10



Austernmesser „ORANGE“

oyster knife
 abre ostras
 couteau à huîtres



Edelstahlklinge zum Einstechen in die Schale, mit Fingerschutz
 to open oysters easily, with guard
 para abrir ostras fácilmente con protección para los dedos
 pour ouvrir facilement les huîtres avec protection pour les doigts

	→ cm	€
88840	15	4,10



Dekoriermesser „ORANGE“

decorating knife „cannelé“
 cuchillo acanalador
 couteau cannelé



gezahnte Klinge aus geschärftem Edelstahl
 serrated sharpened blade, stainless steel
 hoja de sierra afilada, acero inoxidable
 lame inox microdentée

	→ cm	€
88843	19	5,90



Käsehobel „ORANGE“

cheese slicer
 rebanador de queso
 couteau tranche-fromage



zum Schneiden von dünnen Käsescheiben
 to cut thin slices of cheese
 para cortar lonchas finas de queso
 pour couper de fines tranches de fromage

	→ cm	€
88853	21,5	5,90



Streichpalette „BLUE“

spatula
espátula
spatule



flexible Edeltahlklinge, rutschfester Griff, hitzebeständig

flexible blade stainless steel, non-slip handle, heat-resistant

hoja flexible acero inoxidable mango polipropileno termoresistente anti-deslizante

lame inox flexible, manche antiglisse en polypropilène thermorésistant

	cm	→ cm	€
88920	35 x 5	48,5	9,70
88921	30,5 x 4,5	43,5	8,50
88922	25 x 4	38,0	7,80
88923	20 x 3	33,5	6,50



Winkelpalette „BLUE“

spatula
espátula
spatule



flexible Edeltahlklinge

flexible blade stainless steel

hoja flexible acero inoxidable

lame inox flexible

	cm	→ cm	€
88928	17 x 5	30	6,80



Gebäckpalette „BLUE“

pastry spatuala
paleta pastelera
spatule pâtissière



flexible Edeltahlklinge

flexible blade stainless steel

hoja flexible acero inoxidable

lame inox flexible

	cm	→ cm	€
88932	17 x 7,5	29,5	7,60



Wender „BLUE“

turner
espátula
spatule



flexible Edeltahlklinge

flexible blade stainless steel

hoja flexible acero inoxidable

lame inox flexible

	cm	→ cm	€
88933	15 x 6	27,5	6,10



Winkelpalette „BLUE“

turner
espátula
spatule

flexible Edelstahlklinge
flexible blade stainless steel
hoja flexible acero inoxidable
lame inox flexible



	cm	→ cm	€
88935	34 x 5	47,5	9,90
88937	24 x 4	36	7,10
88938	18,5 x 3	32	6,40



Wender „BLUE“

turner
espátula
spatule

flexible Edelstahlklinge
flexible blade stainless steel
hoja flexible acero inoxidable
lame inox flexible



	cm	→ cm	€
88939	24 x 7,5	37,5	9,10



Wender „BLUE“

turner
espátula
spatule

perforiert, flexible Edelstahlklinge
perforated, flexible blade stainless steel
hoja flexible inox agujereada
lame ajourée inox flexible



	cm	→ cm	€
88940	24,5 x 7,5	37,5	9,40



Wender „BLUE“

turner
espátula para plancha
spatule

flexible Edelstahlklinge
flexible blade stainless steel
hoja flexible acero inoxidable
lame inox flexible



	cm	→ cm	€
88941	20 x 7,5	33	8,00
88942	15 x 9	28	7,90



Spachtel / Schaber „BLUE“

scraper
espátula plancha
spatule coudée spéciale grill

starre Edelstahlklinge
rigid blade stainless steel
hoja rígida acero inoxidable
lame inox rigide



	cm	→ cm	€
88929	11 x 10	25	7,60



Spachtel / Fettabstecher „BLUE“

scraper
espátula plancha
spatule coudée spéciale grill

starre Edelstahlklinge
rigid blade stainless steel
hoja rígida de acero inoxidable
lame rigide inox



	cm	→ cm	€
88946	17 x 10	30	9,10
88947	15 x 7,5	28	7,60



Aufstrichmesser „BLUE“

sandwich knife
cuchillo para untar
couteau à tartiner

flexible Edelstahlklinge
flexible blade stainless steel
hoja flexible acero inoxidable
lame inox flexible



	cm	→ cm	€
88948	8,5 x 3	18,5	2,80



Teigschaber / Abstecher „BLUE“

dough scraper
corta pasta
coupe-pâte

starre Edelstahlklinge
rigid blade stainless steel
hoja rígida de acero inoxidable
lame rigide inox



	cm	€
88930	15,5 x 8	5,20



Pizzaschneider „BLUE“

pizza cutter
cortador de pizza
coupe-pizza
ergonomischer Griff
ergonomic handle
mango ergonómico
manche ergonomique



	Ø cm	→ cm	€
88949	10	20	6,70



Eierschneider

egg cutter
corta huevos
coupe-oeufs
zum Längs- und Querteilen von hart gekochten Eiern
to cut hard-boiled eggs
corta a rodajas un huevo duro
en rondelles



	cm	↑ cm	€
88099	14,5 x 8	2,5	2,50



Hummerbrecher

lobster cracker
pinza bogavante
pince à homard



	cm	€
74201	14 x 5,5	8,80



Schneebeesen

whisk
batidor
fouet



	Drähte / wires	→ cm	€
00744	8	28	6,60
00745	8	33	6,80
00746	8	38	8,40
00747	8	43	9,50
00740	8	48	10,00

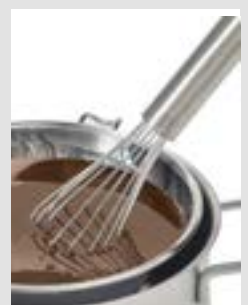



Passiersieb

strainer
colador
passoire



feines Siebgewebe mit ca. 6 Löchern pro 1 cm²

fine mesh with 6 holes per 1 cm²

malla fina con 6 agujeros por 1 cm²

toile fine avec 6 trous pour 1 cm²

	Ø cm	→ cm	€
88618	30,0	60,0	50,00
88639	33,5	62,5	54,00



Passiersieb

strainer
colador
passoire



feines Siebgewebe mit ca. 6 Löchern pro 1 cm²

fine mesh with 6 holes per 1 cm²

malla fina con 6 agujeros por 1 cm²

toile fine avec 6 trous pour 1 cm²

	Ø cm	→ cm	€
74700	14	30	7,80
74701	16	32	10,00
74702	18	34	13,00
74703	20	36	14,40
74705	24	41	16,40
74706	26	43	19,00



Doppelnetz / double mesh

Passiersieb

strainer
colador
passoire



mit Doppelnetz, Netz außen: ca. 2 Löcher pro 1 cm, Netz innen: ca. 5 Löcher pro 1 cm

with double mesh, outer mesh about 2 holes per cm, inner mesh about 5 holes per cm

con malla doble, malla exterior aprox. 2 agujeros /cm, interior aprox. 5 agujeros /cm

avec double étamine, extérieure env. 2 trous/cm, intérieure environ 5 trous/cm

	Ø cm	→ cm	€
74721	19,5	41,0	12,80
74722	24,5	56,5	20,00



STRAINERS

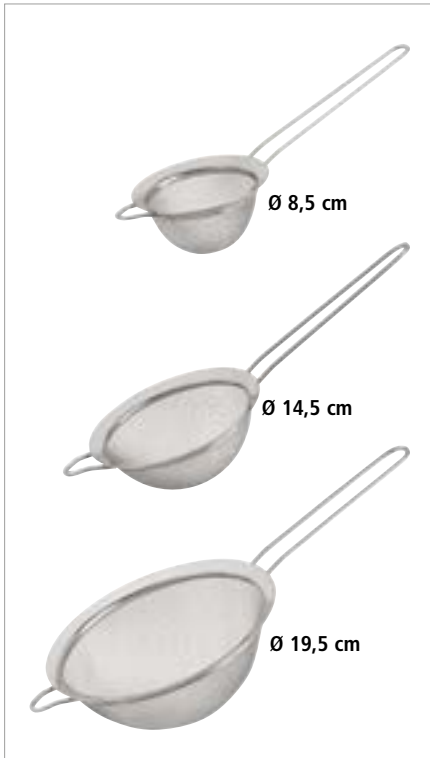

Passiersieb, 3er Set

strainer, 3 pcs.
colador, set de 3
passoire, set de 3



3-teiliges Set bestehend aus 3 Sieben:

Ø 8,5 cm, L: 22,5 cm / Ø 14,5 cm, L: 32 cm / Ø 19,5 cm, L: 38,5 cm

set of 3 consisting of 3 sieves:

Ø 8,5 cm, L: 22,5 cm / Ø 14,5 cm, L: 32 cm / Ø 19,5 cm, L: 38,5 cm

set de 3 que consta de 3 tamices:

Ø 8,5 cm, L: 22,5 cm / Ø 14,5 cm, L: 32 cm / Ø 19,5 cm, L: 38,5 cm

set de 3 composé de 3 tamis :

Ø 8,5 cm, L: 22,5 cm / Ø 14,5 cm, L: 32 cm / Ø 19,5 cm, L: 38,5 cm

	Ø cm	→ cm	€ / set
74707	8,5/14,5/19,5	22,5/33/38,5	16,00



3 teilig
3 pcs. set



Barsieb

bar strainer
colador de cóctel
tamis cocktail



	Ø cm	↑ cm	Griff / handle cm	€
93318	8,5	5	11,5	4,50



Gazespitzsieb

conical strainer with wire gauze
colador chino de malla
chinois renforcé avec maille fine



hochglanzpoliert, mit rundem Hohlgriff, ca. 9 Löcher pro 1 cm²

mirror polished, 9 holes per 1 cm²

pulido brillante, mango hueco, 9 agujeros por 1 cm²

poli brillant, manche creux, 9 trous pour 1 cm²

	Ø cm	↑ cm	Griff / handle cm	€
88717	25	19	24	46,20



Spitzsieb

conical strainer
colador cónico
chinois



mit Lochung Ø 1,5 mm, auch in der Kegelspitze, mit Flachstiel, mit Stützstiel zum Einhaken in den Topfrand

with Ø 1,5 mm holes (including the tip), with flat handle, with supporting hook

con agujeros finos de Ø 1,5 mm (incluída la punta), con mango plano y gancho

perforations fines 1,5 y compris à la pointe, manche plat et crochet

	Ø cm	↑ cm	Griff / handle cm	€
00771	23	18	16,5	27,30



Seiher
strainer
colador
passoire



	Ø cm	↑ cm	€
74708	28,5	10	16,00



Seiher
strainer
colador
passoire



mit 2 Muschelgriffen
with 2 shell shaped grips
con dos asas
à 2 anses moulées

	Ø cm	↑ cm	€
00780	36	19	12,50



Pommes-Frites-Seiher

fry dripping tray
escurridor de fritos
égouttoir à friture



herausnehmbarer Locheinsatz, mit Handgriff
removable drainer, with handle
fondo de colador desmontable, con asa
fond démontable, avec poignée

	Ø cm	↑ cm	€
00785	39	19	34,00



00772

00779

Salzstreuer

salt shaker
salero
salière



Pommes-Frites Streuer mit Schraubkappe
for french fries, cover to screw
para patatas fritas, tapa de rosca
pour les frites, couvercle à visser

	Ø cm	↑ cm		€
00772	8	17	stainless steel	14,00
00779	8	17	aluminium	9,90



74402

Back- / Frittierlöffel

skimmer / spider
espumadera para fritos
écumoire à friture



elektropoliert, sehr stabile Ausführung
electro polished, heavy gauge
electro pulido, alta calidad
poli électrolythique, qualité extra

	Ø cm	→ cm	€
74402	16	48	19,40
74404	20	54	24,00



Wasserbadschüssel
 bain marie bailing bowl
 cazo para baño maría
 récipient bain-marie



hochglanzpoliert, mit Drahtgriff Ø 5 mm
 mirror polished, with wire handle Ø 5 mm
 pulido brillante, mango varilla Ø 5 mm
 poli brillant, manche fil épaisseur Ø 5 mm

	Ø cm	↑ cm	Griff / handle cm	ltr.	€
74731	18	9	15	1,5	14,70



Anwendungsbeispiel, Topf ≥ 20 cm
 Application Example, pot ≥ 20 cm



Saucen- und Fondantrichter
 sauce and confectionary funnel
 embudo para salsa y confitería
 entonnoir à sauce et confiserie



ergonomischer Griff, Maßskalierung innen, mit 3 Düsen Ø 4, 5, 6 mm, inklusive Ständer und Auffangschale

ergonomic handle, scaling inside, with 3 different nozzles Ø 4, 5, 6 mm, including wire rack a. dripping dash
 mango ergonómico, escalado interior, con 3 boquillas, Ø 4, 5, 6 mm, incl. pie de alambre y bandeja recoge gotas
 manche ergonomique, mise à l'échelle à l'intérieur, 3 douilles de Ø 4, 5 et 6 mm, inclut pied avec ramasse-gouttes

	Ø cm	↑ cm	ltr.	€
77338	21	31,5	1,5	98,00



Anwendungsbeispiel
 application example



Maßskalierung innen
 scaling inside



Gemüsehobel, Mandoline
 mandolin
 mandolina
 mandoline



mit 7 verschiedenen Klingen (Breite 10 cm), Anti-Rutsch-Gestell, Schutzabdeckung
 with 7 interchangeable blades (width 10 cm), non-slip folding stand, safety guard
 con 7 cuchillas intercambiables (corte 10 cm), pie plegable anti-deslizante, carro de seguridad
 7 peignes interchangeables (largeur 10 cm), pied repliable anti-glisse, chariot

	cm	↑ cm	€
88688	40,5 x 12	5 / 25	77,70



A 7 verschiedene Klingen
 7 interchangeable blades
B Praktische Transportbox
 Practical transport box



Messbecher
graduated jug
jarra graduada
pichet gradué



außen hochglanzpoliert, innen matt poliert, mit Maßskalierung außen
outside mirror polished, inside matt polished, with stamped liter scale
exterior pulido brillante, interior pulido mate con escalado en litros
extérieur poli brillant, intérieur poli mat, graduation en litres

	Ø cm	↑ cm	ltr.	€
30045	10	14	1	13,40

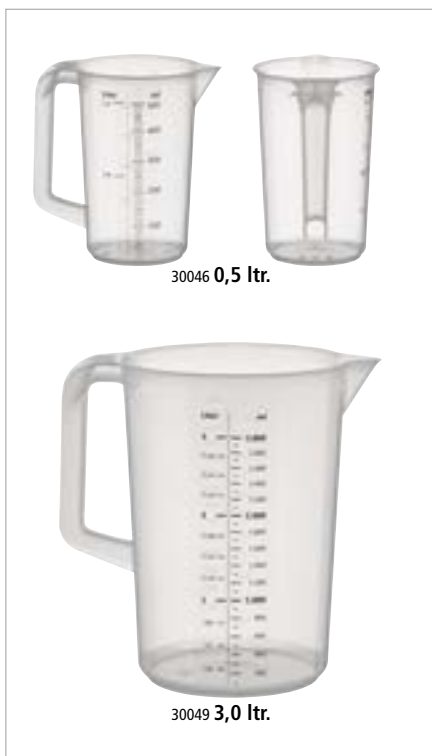

Messbecher „PRO“
measuring cup
jarra graduada
pichet gradué



mit geschlossenem Griff, mit geprägter Maßskalierung außen, l- und ml-Liter-Einteilung
with closed handle, with stamped printed liter and ml scale
con asa cerrada, con escala estampada de litros y ml
avec poignée fermée, avec échelle en litres et ml imprimée et tamponnée

	Ø cm	↑ cm	ltr.	€
30046	9	14	0,5	3,40
30047	12	16,5	1,0	4,50
30048	15	20,5	2,0	7,80
30049	17	23,5	3,0	10,00
30057	20	25,5	5,0	12,60



einfaches Eingießen
easy pouring



Messbecher „STACKABLE“
measuring cup
jarra graduada
pichet gradué



mit offenem Griff und geprägter Maßskalierung außen, platzsparend stapelbar
with open handle and embossed dimension scaling on the outside, space-saving stackable
con asa abierta y escala de dimensiones en relieve en el exterior, apilable para ahorrar espacio
avec une poignée ouverte et une échelle de dimensions en relief à l'extérieur, empilable et peu encombrante

	Ø cm	↑ cm	ltr.	€
30059	7	12	0,25	2,50
30061	9	14	0,5	3,10
30062	12	16,5	1,0	4,10
30063	15	20,5	2,0	7,20



offener Griff
open handle

einfaches Eingießen
easy pouring

stapelbar
stackable



1 ltr.

inkl. Spritzschutz / incl. splash guard

Rührbecher mit Deckel

stirring cup with lid
vaso agitador con tapa
tasse à remuer avec couvercle



inklusive Spritzschutz und geprägter Maßskalierung außen, platzsparend stapelbar

included splash guard with open handle and embossed dimension scaling on the outside, space-saving stackable

protección contra salpicaduras incluida con asa abierta y escala de dimensiones en relieve en el exterior, apilable para ahorrar espacio

protection contre les éclaboussures incluse avec une poignée ouverte et une échelle de dimensions en relief à l'extérieur, empilable et peu encombrante

	Ø cm	↑ cm	ltr.	€
30058	12,5	16	1,0	6,60



Griff mit Daumenmulde
handle with thumb recess



mit Silikonring
with silicone ring



Schaumspesering

mousse ring
aro redondo para semifríos
cercle à mousse rond

matt poliert, fugenlos
matt polished, seamless
pulido mate, sin soldadura
poli mat, sans soudure



	Ø cm	↑ cm	€
00098	6	4,5	3,20
00099	7	4,5	3,70
00092	8	4,5	3,80
00093	10	4,5	5,30
00094	12	4,5	7,00



00110

Schaumspeseringe, 5er Set

mousse ring, 5 pcs.
juego aros para emplatar o para semifríos
jeu de cercles à mousse inox, ronds

5-teilig: 4 Formen + 1 Verdichter, matt poliert, fugenlos

5 pcs. set: 4 shapes and 1 pusher, matt polished, seamless

juego de 5 piezas: 4 aros redondos y 1 pulsador, para dar forma, satinado sin soldadura

jeu de 5 pièces: 4 cercles et 1 poussoir. Idéal pour dressage sur assiette ou mousse, poli mat, sans soudure



	Ø cm	↑ cm	pcs.	€ / set
00110	6	4,5	5	17,60
00113	8	4,5	5	19,00



Dariolformen, 2er Set

dariol moulds, 2 pcs.
juego 2 flaneras
jeu de 2 moules à flan

hochglanzpoliert
mirror polished
pulido brillante
poli brillant



	Ø cm	↑ cm	ltr.	pcs.	€ / set
00106	6,5	4,5	0,1	2	5,50



Tortenring

cake setting ring
aro de tarta
cercle à gâteaux

stufenlos verstellbar, ohne Griff
adjustable, without handle
ajustables, sin asa
ajustables, sans poignée



	Ø cm	↑ cm	€
00040	16,5 - 32	7	8,70



Anwendungsbeispiel
application example



Backform

baking pan
marco pastelero
forme à gateaux

stufenlos verstellbar, aus flexiblem Edelstahl
adjustable, made of flexible stainless steel
ajustable, de acero inoxidable flexible
ajustable, en acier inox flexible



	cm	↑ cm	€
00042	19 x 28 - 34 x 54	5	17,90



Anwendungsbeispiel
application example



Ausstellblech / Thekenblech

display tray
bandeja pastelera
plaque pâtissière

hitzebeständig bis 230°C
heat-resistant up to 230°C
resistente al calor hasta 230 °C
résistant à la chaleur jusqu'à 230°C



	cm	↑ cm	€
13377	40 x 25	2	11,80
13378	48 x 32	2	14,00
13379	60 x 40	2	18,00



Profi-Eimer

bucket
cubo
seau



mit Ausgießer und geprägter Maßskalierung innen
with spout and embossed dimension scaling inside
con pico y escala de medición en relieve en el interior
avec bec verseur et échelle de mesure en relief à l'intérieur

	Ø cm	↑ cm	ltr.	Farbe / Colour	€
30075	28,5	28,5	10,5		13,20
30076	33,0	32,0	17,0		17,00
30077	28,5	28,5	10,5		13,20
30078	33,0	32,0	17,0		17,00



mit Griff
with handle



Maßskalierung innen
dimension scaling inside



Auslaufnase für sicheres Handling
discharge nose for safe handling



Mehlschaufel „PRO“

scoop
pala
pelle à farine



stehende Schaufel, auch für Flüssigkeiten geeignet
standing scoop, also applicable for liquids
pala, ápto también para líquidos
adaptée pour poudres et liquides

	cm	↑ cm	ltr.	Farbe / Colour	€
00610	25 x 9	4,5	0,25		2,80
00611	31 x 12	5,5	0,5		3,30
00612	35 x 13	6	0,7		4,80



Schaufel „ECO“

scoop
pala
pelle



stabil und bruchsicher
stable and unbreakable
estable e irrompible
stable et incassable

	→ cm	ltr.	€
00694	18	0,110	1,50
00695	24	0,230	1,80
00696	31	0,470	2,20
00697	33	0,725	3,40



Zum schnellen und zielgerichteten Abfüllen von Lebensmitteln
for fast and targeted filling of foodstuffs



30065 Ø 6 cm



30067 Ø 10 cm



30068 Ø 12 cm



mit Sieb
with strainer

30070 Ø 17 cm



mit Sieb
with strainer

30071 Ø 21 cm

Trichter „PROFI“

funnel
embudo
entonnoir

mit Öse
with eyelet
con ojal
avec œillet



	Ø cm	Ø mm Durchlass		€
30065	6	8		1,10
30066	8	11		1,30
30067	10	12		1,50
30068	12	12		2,20
30069	14	15		4,40
30070	17	17	mit Sieb / with strainer	6,20
30071	21	20	mit Sieb / with strainer	7,60



erleichtert das Einfüllen
facilitates filling



Anwendungsmöglichkeit
applicability



mit einsetzbarem Sieb
with insertable strainer



mit einsetzbarem Sieb
with insertable strainer



Limetten- / Zitronenpresse

lime- / lemonpress
 exprimidor de limón / lima
 presse citron

2 Pressringe für Zitrone und Limette

2 squeezing rings for lemon and lime
 2 anillos exprimidores para limón y lima
 2 anneaux à presser pour le citron et le lime



	cm	↑ cm		€
93214	21 x 7	5		14,60



Limettenpresse

lime press
 prensa de limón
 presse citron



	cm	↑ cm		€
93189	21 x 7	5		11,40



Zitruspresse

citrus squeezer
 exprimidor cítricos
 presse-citron

hochglanzpoliert, 2-teilig

mirror polished, 2 pcs.
 pulido brillante, 2 piezas
 poli brillant, 2 pièces



	Ø cm	↑ cm	ltr.	€
71431	12 / 17	10,5	0,35	13,80



Pinsel

brush
 brocha
 pinceau pâtissier

weißgebleichte, naphthalinfreie Borsten, temperaturbeständig von -40°C bis +95°C

bleached bristles, heat-resistant from -40°C to +95°C
 cerdas blanqueadas, resistencia térmica -40°C hasta +95°C
 soies blanchies sans naphthaline, résistance de -40°C à +95°C



	cm	→ cm		€
77350	4 x 1	23,5		6,80



Panierstation, 3-teilig

breading set, 3 pcs. set
 estación de empanado, set de 3
 station de panure, set de 3

zum Panieren von Fleisch, Gemüse, Käse etc.

for breading meat, vegetables, cheese etc.
 para empanar carne, verduras, queso, etc.
 pour paner la viande, les légumes, le fromage etc.



	cm	↑ cm		€ / set
66904	45,5 x 18	2,5		14,00





Bonspieß
bill spike
pinchanotas
pique-bons



Spieße aus flexiblem Kunststoff, mit stumpfen Enden zur Unfallverhütung
spikes made of flexible plastic, with blunt ends to prevent accidents
pinchos de plástico flexible
piques en plastique flexible

	cm	↑ cm	€
88855	9 x 5,5	10,5	3,80



Bonleiste
bill rail
portafichas
barre porte-bons



matt poliert, mit Kugel-Greifsystem, zur Wandmontage geeignet, auch mit Magneten nutzbar
matt polished, small balls hold the bills, suited for wall fastening, can also be used with magnets
pulido mate, con sistema de bolas para colgar las notas para fijar en la pared, puede usarse con imán
poli mat, avec billes pour fixer sans effort tous types de fiches et papiers, peut se fixer sur plaque aimantée

	cm	↑ cm	€
88900	40 x 8	2	17,00
88901	50 x 8	2	18,40
88902	60 x 8	2	20,00



Magnet-Messerhalter
magnetic knife rack
barra magnética para cuchillos
barre aimantée pour couteaux



mit 2 Magnetschienen und Haken, aus massivem Kunststoff, zur Wandmontage geeignet, Lieferung ohne Deko
with 2 magnet racks and hooks, strong plastic, suited for wall fastening
con 2 railes magnéticos y ganchos, plástico macizo, fijación en pared
avec 2 rails aimantés et crochets, plastique robuste, fixation murale

	→ cm	€
88911	45	11,20
88912	60	13,60



Folien-Abreißvorrichtung
clingfilm tear-off dispenser
dispensador de film
dérouleur de film



mit Abreißkante / Säge-Messer, für Endlosfolie, als Tischgerät oder Wandgerät verwendbar
with saw, for endless rolls, can be fixed on the wall
con sierra para rollo de film continuo, se puede fijar en la pared
avec lame dentée pour rouleau de film, peut être fixé au mur

	cm	↑ cm	€
88288	34 x 16	9	für Folienbreite 30 cm / for film width 30 cm para film ancho 30 cm / pour film largeur 30 cm 41,00
88287	49 x 16	9	für Folienbreite 45 cm / for film width 45 cm para film ancho 45 cm / pour film largeur 45 cm 46,00



Schneidbrettständer

cutting board rack
soporte para tablas
rack pour planches à découper

für 6 Schneidbretter bis 25 mm Stärke, Lieferung ohne Deko
for 6 chopping boards up to 25 mm thickness
para 6 tablas de corte de 25 mm
pour 6 planches de 25 mm



	cm	↑ cm	€
88903	27 x 31	28	33,60



Eiswaffel-Ständer

cornet stand
soporte cucuruchos
support à cornets

matt poliert, mit 4 Löchern, 2 x Ø 31 mm + 2 x Ø 26 mm
matt polished, with 4 holes, 2 x Ø 31 mm + 2 x Ø 26 mm
pulido mate, con 4 agujeros 2 x Ø 31 mm + 2 x Ø 26 mm
poli mat, 4 trous - 2 x Ø 31 mm + 2 x Ø 26 mm



	cm	↑ cm	€
11881	27,5 x 9,5	9	20,90



Eisportionierer

ice cream scoop
cuchara para helado
cuillère à glace

hochglanzpoliert, mit Edelstahlfeder (physikalisch bedingt nicht korrosionsbeständig)
mirror polished, spring steel, spring is not stainless
pulido brillante, muelle de acero especial, no resistente al óxido
poli brillant, ressort acier spécial, non résistant à l'oxydation



	Ø cm	→ cm	ltr.	€
71006	6,5	23,5	1/12	11,60
71005	6,0	22,5	1/16	11,60
71004	5,5	22,0	1/20	11,60
71003	5,0	22,0	1/24	11,60
71002	5,0	21,5	1/30	11,60
71001	4,5	21,0	1/36	11,60

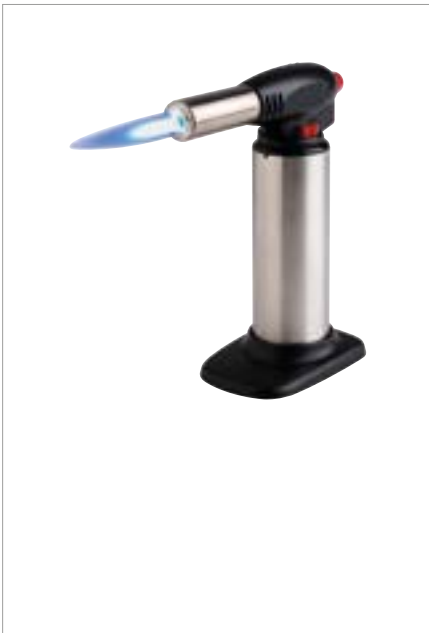

Flambierbrenner

chefs blow torch
soplete de cocina para flambear
chalumeau de cuisine

mit handelsüblichem Feuerzeuggas auffüllbar, Flamme einstellbar bis ca. 1300° C, Brenndauer von mindestens 60 Minuten

to be filled with commercial lighter gas, flame adjustable up to approx. 1300° C, burning time of at least 60 minutes
rellenable con gas de mechero comercial, llama ajustable hasta 1300 ° C, tiempo de combustión de al menos 60 minutos
rempli avec gaz pour briquet commercial, flamme réglable jusqu'à 1300 ° C, temps de combustion d'au moins 60 minutes



	Ø cm	↑ cm	€
77315	4,5	16,5	33,00



Anwendungsbeispiel
application example



SQUEEZE BOTTLES



Quetschflasche

squeeze bottle
bote dosificador flexible
bouteille verseuse souple



mit Schraubdeckel und Verschlusskappe, ideal für Dressing und Saucen

with tight-screw and cap, ideal for dressing and sauce

con tapa de rosca y tapón, ideal para aliño y salsas

avec couvercle à visser et bouchon de fermeture, idéal pour vinaigrette et sauces

	Ø cm	↑ cm	ltr.	Farbe / Colour	€
93259	8	26,5	1,025		2,40
93260	8	26,5	1,025		2,40
93261	8	26,5	1,025		2,40



große „Öffnung“
big „mouth opening“



Quetschflasche

squeeze bottle
bote dosificador flexible
bouteille verseuse souple



mit Schraubdeckel und Verschlusskappe, ideal für Dressing und Saucen

with tight-screw and cap, ideal for dressing and sauce

con tapa de rosca y tapón, ideal para aliño y salsas

avec couvercle à visser et bouchon de fermeture, idéal pour vinaigrette et sauces

	Ø cm	↑ cm	ltr.	Farbe / Colour	€
93155	6,5	24	0,65		1,90
93156	6,5	24	0,65		1,90
93157	6,5	24	0,65		1,90



Quetschflasche „MINI“, 4er Set

squeeze bottle, 4 pcs.
bote dosificador flexible, 4 pz.
bouteille verseuse souple, 4 pc.



mit Schraubdeckel und Verschlusskappe, ideal für Dressing und Saucen

with tight-screw and cap, ideal for dressing and sauce

con tapa de rosca y tapón, ideal para aliño y salsas

avec couvercle à visser et bouchon de fermeture, idéal pour vinaigrette et sauces

	Ø cm	↑ cm	ltr.	pcs.	€/set
93225	3,0	8,5	0,03	4	5,50
93226	3,5	9,5	0,05	4	5,90

SQUEEZE BOTTLES



Quetschflasche, 6er Set

squeeze bottle, 6 pcs.
bote dosificador flexible, set de 6
bouteille verseuse souple, set de 6



mit Schraubdeckel und Verschlusskappe, ideal für Dressing und Saucen

with tight-screw and cap, ideal for dressing and sauce

con tapa de rosca y tapón, ideal para aliño y salsas

avec couvercle à visser et bouchon de fermeture, idéal pour vinaigrette et sauces

	Ø cm	↑ cm	ltr.	Farbe / Colour	pcs.	€/ set
93250	5	18,0	0,26	White	6	7,60
93251	5	18,0	0,26	Yellow	6	7,60
93252	5	18,0	0,26	Red	6	7,60
93253	7	20,0	0,49	White	6	10,60
93254	7	20,0	0,49	Yellow	6	10,60
93255	7	20,0	0,49	Red	6	10,60
93256	7	26,5	0,76	White	6	12,00
93257	7	26,5	0,76	Yellow	6	12,00
93258	7	26,5	0,76	Red	6	12,00



mit Verschlusskappe
with cap



große „Öffnung“
big „mouth opening“



Quetschflasche „NON DRIP“

squeeze bottle
bote dosificador flexible
bouteille verseuse souple



mit Schraubdeckel und Verschlusskappe, ideal für Dressing und Saucen

with tight-screw and cap, ideal for dressing and sauce

con tapa de rosca y tapón, ideal para aliño y salsas

avec couvercle à visser et bouchon de fermeture, idéal pour vinaigrette et sauces

	Ø cm	↑ cm	ltr.	Farbe / Colour	€
93270	5,5	21,0	0,35	White	4,00
93271	5,5	21,0	0,35	Yellow	4,00
93272	5,5	21,0	0,35	Red	4,00
93273	7,0	25,5	0,75	White	5,10
93274	7,0	25,5	0,75	Yellow	5,10
93275	7,0	25,5	0,75	Red	5,10



mit Skalierung
with scaling



tropffrei
non drip



Quetschflasche

squeeze bottle
bote dosificador flexible
bouteille verseuse souple



ideale Größe, um Speiseteller mit Saucen zu verzieren, mit Verschlusskappe

ideal size to garnish plates with sauces, with cap

tamaño ideal para decorar platos con salsas, con tapón

taille idéale pour décorer assiettes avec des sauces, avec bouchon

	Ø cm	↑ cm	ltr.	€
93154	5	16	0,2	1,50
93163	6	21	0,35	2,40



Dosierspender
dispenser
dispensador de salsa
doseur à sauce

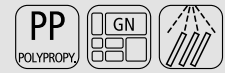

	cm	↑ cm	ltr.	GN	€
93280	17,6 X 16,2	27	2,6	1/6	26,00

Dosierpumpe, Hubvolumen 30 ml
dosing pump / riser tube, swept volume 30 ml
bomba de salsa, sola, cada dosis 30 ml
pompe à sauce, 30 ml par dose



	cm	↑ cm	ltr.		€
93281	12,5 X 4,5	26	0,30	fits to 93280	18,00



Dosierpumpe
dosing pump / riser tube
bomba de salsa, sola
pompe à sauce



Hubvolumen 30 ml
swept volume 30 ml
cada dosis 30 ml
30 ml par dose

	Ø cm	↑ cm		€
88271	4,5	40		11,10



Eier-Box
eggs box
caja para huevos
boîte à oeufs



mit luftdichtem Deckel, für 4 Lagen à 30 Eier, Lieferung inkl. 8 Lagen, Größe Lage: 28 x 28 cm
with airtight cover, capacity: 4 trays of 30 eggs, delivery with 8 trays, size of tray: 28 x 28 cm
capacidad para 4 bandejas de 30 huevos, tapa hermética, se entrega con 8 bandejas, formato bandejas 28 x 28 cm, apto para lavavajillas
pour 4 plateaux de 30 oeufs chacun, apte pour 4 plateaux plats, couvercle hermétique, livré avec 8 plateaux, dimension plateau 28x28 cm, lavable en lave-vaisselle

	cm	↑ cm	GN	€
82419	35,4 x 32,5	20	2/3	39,90



Aufsteller „ACHTUNG RUTSCHGEFAHR“
stand
letrero
panneau



	cm	↑ cm	Farbe / Colour	€
71421	30 x 63	63	Yellow	8,90

Pizzaform



9 sizes



Pizzaform pizza dish molde de pizza moule à pizza



Blaublech, nicht beschichtet, lange Lebensdauer, hitzebeständig bis 360 °C
 metal sheet, without coating, long endurance, heat resistant up to 360 °C
 chapa azul, sin revestimiento, larga vida útil, resistente al calor hasta 360 °C
 métal, sans revêtement, longue durée de vie, à la chaleur jusqu'à 360 °C

	∅ cm	↑ cm	€
73502	16 - 18	2,5	4,10
73505	22 - 24	2,5	7,00
73506	24 - 26	2,5	7,60
73507	26 - 28	2,5	7,90
73508	28 - 30	2,5	8,30
73509	30 - 32	2,5	8,80
73510	34 - 36	2,5	9,00
73511	38 - 40	2,5	11,00
73513	48 - 50	3,0	16,20



stapelbar
stackable



Backhandschuhe baking mittens manoplas de panadero gants de boulanger

Leder, gefüttert, Einheitsgröße, mit Stulpen, extrem hitzebeständig bis 250°C
 leather, inner lining, one size, with cuffs, extremely heat resistant up to 250°C
 cuero interior forrado, talla única, resiste a temperaturas hasta 250°C
 cuir intérieur doublé, taille unique, résiste à maxi 250°C

	→ cm	€
88090	45	28,00



Gestell für Pizzaformen

rack for pizza pans
rejilla para pizzas
support pour moules à pizza



Edelstahlgestell zusammenklappbar für Pizzaformen Ø 28 cm, Abstand zwischen den Ebenen 5,5 cm

foldable stainless steel rack for pizza dishes ø 28 cm, distance between the levels 5.5 cm
rejilla plegable de acero inoxidable para moldes de pizza de Ø 28 cm, distancia entre los niveles 5,5 cm
support en acier inox pliable pour les moules à pizza de Ø 28 cm, distance entre les niveaux 5,5 cm

	cm	↑ cm	€
73515	26 x 25	26	7,60



Backofen geeignet
suitable for oven



Pizzaform für Ø 28 cm
pizza dish for Ø 28 cm

Pizzaform
pizza dish
molde de pizza
moule à pizza

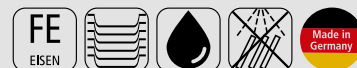

	Ø cm	↑ cm	mm	€
73507	26 / 28	2,5	1	7,90



Pizzaschaufel
pizza peel
pala de pizza
pelle à pizza



	cm	→ cm	€
88080	35 x 30,5	90	39,20
88081	35 x 30,5	130	47,30



Teig- und Pizzaballenbehälter
dough and pizza ball container
recipiente para masa y bolas de pizza
réceptif à pâte et boules à pizza



Innenmaß 56,5 x 36,5 cm, H: 6,5 cm
inner dimension 56,5 x 36,5 cm, H: 6,5 cm
medida interior 56,5 x 36,5 cm, H: 6,5 cm
dimension intérieure 56,5 x 36,5 cm, H: 6,5 cm

	cm	↑ cm	ltr.	€
82440	60 x 40	7	13	12,00



stapelbar
stackable

passender Deckel / fitting lid / tapa adecuada / couvercle approprié

	cm	↑ cm	€
82441	60 x 40	1	10,00



Pizzaform
pizza dish
molde de pizza
moule à pizza



Blaublech, rechteckig, Rand umgelegt, hitzebeständig bis 360 °C
blue steel baking sheet, rectangular, heat resistant up to 360 °C
chapa azul rectangular, borde plagado, resistente al calor hasta 360 °C
métal, rectangulaire, bord plié, à la chaleur jusqu'à 360 °C

	cm	↑ cm	€
88256	60 x 40	2,5	26,00



Pizzaschneider „BLUE“
pizza cutter
cortador de pizza
coupe-pizza



ergonomischer Griff
ergonomic handle
mango ergonómico
manche ergonomique

	Ø cm	→ cm	€
88949	10	20	6,70



Teigschaber / Abstecher „BLUE“
dough scraper
corta pasta
coupe-pâte



starre Edelstahlklinge
rigid blade stainless steel
hoja rígida de acero inoxidable
lame rigide inox

	cm	€
88930	15,5 x 8	5,20

**Mehlschaufel „PRO“**

scoop
pala
pelle à farine

stehende Schaufel, auch für Flüssigkeiten geeignet

standing scoop, also applicable for liquids

pala, ápto también para líquidos

adaptée pour poudres et liquides



	cm	↑ cm	ltr.	Farbe / Colour	€
00610	25 x 9	4,5	0,25		2,80
00611	31 x 12	5,5	0,5		3,30
00612	35 x 13	6	0,7		4,80

**Saucengießlöffel „CLASSIC“**

sauce / gravy ladle
cucharón de salsa
cuillère à sauce

hochglanzpoliert, ergonomisch profilierter Hohl-Griff, fugenlos

mirror polished, ergonomic designed handle, seamless

pulido brillante, asa ergonómica, sin soldadura

poli brillant, manche ergonomique, monobloc (sans soudure)



	cm	Griff / handle cm	ltr.	€
75906	7 x 5,5	22	0,02	8,70

**Pinsel**

brush
brocha
pinceau pâtissier

weißgebleichte, naphtalinfreie Borsten, temperaturbeständig von -40°C bis +95°C

bleached bristles, heat-resistant from -40°C to +95°C

cerdas blanqueadas, resistencia térmica -40°C hasta +95°C

soies blanchies sans naphtaline, résistance de - 40°C à + 95°C



	cm	→ cm	€
77350	4 x 1	23,5	6,80

**Schüssel**

bowl
ensaladera
saladier
glasklar

crystal clear

cristalina

transparent



	Ø cm	↑ cm	ltr.	Farbe / Colour	€
30260	32,5	10	4		4,70
30263	40	12	8		9,40

**Korkuntersetzer**

cork mat
salvamanteles
dessous-de-plat liège

ideal für Servier- und Eisenpfannen

ideal for iron pan

ideal para servir en sartenes de chapa

idéal pour présenter les poêles forgées sur table



	Ø cm	↑ cm	€
73750	24	2	14,20





Hauben & Zubehör

covers & accessories
campanas & accesorios
cloches & accessoires

GN COVERS.....	484
GN ROLLTOP COVERS.....	487
ROLLTOP COVERS.....	488
SUPER DOME.....	489
PLATE COVERS.....	490
COVERS.....	491
LIDS.....	493
COOLERS.....	496
TO GO CUP.....	497

QUALITÄTSHAUBEN

11042
GN 1/1

11041
GN 1/2



11043 GN 1/3



11044 GN 2/4



11041 GN 1/2



11042 GN 1/1

GN Abdeckhaube

GN cover
GN cubierta
GN cloche



passend für GN Tablett, glasklarer Kunststoff, nahezu bruchfest

suitable for GN trays, clear plastic, nearly unbreakable

apto para bandejas GN, plástico transparente, muy resistente a la rotura

pour bacs et plateaux GN, plastique transparent, très résistant à la casse

	cm	↑ cm	* mm	GN	€
11043	32,5 x 17,6	10,5	3	1/3	17,00
11044	53,0 x 16,2	10,5	3	2/4	23,00

	cm	↑ cm	* mm	GN	€
11041	32,5 x 26,5	9,5	3	1/2	23,00
11042	53,0 x 32,5	9,5	3	1/1	32,00



stapelbar
stackable



GN 1/1 Haube „HOCHSTAPLER“

GN 1/1 cover
GN 1/1 campana
GN 1/1 cloche



glasklarer Kunststoff, Tablett fixiert sich auf der Haube - kein Rutschen möglich, nahezu bruchfest

clear plastic, tray fixes itself on the cover and can not slip off, nearly unbreakable

plástico transparente, la bandeja se fija a la tapa para que no se deslice, muy resistente a la rotura

en plastique transparent, le plat se fixe sur le dessous de la cloche pour ne pas glisser, très résistant à la casse

	cm	↑ cm	GN	fits to	€
11305	53 x 32,5	9	1/1	11300, 11290, 11295	30,00



GN Kuppelhaube

GN cover
GN cúpula
GN cloche bombée

glasklarer Kunststoff, Griff aus Zinkdruckguss

crystal clear plastic, die-cast zinc knob

plástico transparente, asa de zinc fundido a presión

plastique transparente, poignée en zinc moulé sous pression

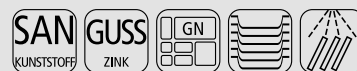

	cm	↑ cm	GN		€
11021	33 x 28	17	1/2	geschlossen / totally closed cerrada / toalemt fermée	29,00
11022	33 x 28	17	1/2	mit Front-Ausschnitt / one long side cut out gran apertura frontal grande ouverture frontale	32,00
11026	54 x 33	20	1/1	geschlossen / totally closed cerrada / toalemt fermée	52,00
11027	54 x 33	20	1/1	mit Front-Ausschnitt / one long side cut out gran apertura frontal grande ouverture frontale	54,00
11028	54 x 33	20	1/1	mit seitlichem Ausschnitt one small side cut out pequeña apertura lateral petite ouverture latérale	54,00



GN COVERS



NEW

11070 GN 1/1

11071 GN 1/1

11072 GN 1/1

11073 GN 1/2

11074 GN 1/2

GN Kuppelhaube

GN cover
GN cúpula
GN cloche bombée



glasklarer Kunststoff, Griff aus Zinkdruckguss

crystal clear plastic, die-cast zinc knob

plástico transparente, asa de zinc fundido a presión

plastique transparente, poignée en zinc moulé sous pression

	cm	↑ cm	GN		€
11070	54 x 33	20	1/1	geschlossen / totally closed cerrada / totalmente fermée	52,00
11071	54 x 33	20	1/1	mit Front-Ausschnitt / one long side cut out gran apertura frontal grande ouverture frontale	54,00
11072	54 x 33	20	1/1	mit seitlichem Ausschnitt one small side cut out pequeña apertura lateral petite ouverture latérale	54,00
11073	33 x 28	17	1/2	geschlossen / totally closed cerrada / totalement fermée	29,00
11074	33 x 28	17	1/2	mit Front-Ausschnitt / one long side cut out gran apertura frontal grande ouverture frontale	32,00



GN 1/1 Haube

GN 1/1 cover
GN 1/1 campana
GN 1/1 cloche



klappbar, passend für GN 1/1-Behälter, GN 1/1-Tabletts, etc., nahezu bruchfest

suitable for GN 1/1 chafing dish, GN 1/1 trays, GN 1/1 pans

plegable, para cubetas GN 1/1, bandejas GN 1/1 etc., muy resistente a la rotura

pliable, pour bacs GN 1/1, plateaux GN 1/1 etc., très résistant à la casse

	cm	↑ cm	GN		€
11013	53,0 x 32,5	6	1/1		29,00



klappbar
adjustable



GN 1/1 Rolltophaube

GN 1/1 rolltop cover
GN 1/1 campana rolltop
GN 1/1 cloche rolltop



patentiert, passend für GN-Behälter, -Tablets, etc., leichtgängig auf- und zuklappbar 90°
patented, suitable for GN trays, solid quality, 90° opening
patentada, para bandejas GN, apertura 90°
brevetée, pour plateaux GN, ouverture 90°

	cm	↑ cm	GN	€
11075	53,0 x 32,5	19	1/1	62,00



GN Rolltophaube

GN rolltop cover
GN campana rolltop
GN cloche rolltop



patentiert, passend für GN-Behälter, -Tablets, etc., leichtgängig auf- und zuklappbar 90°
patented, suitable for GN trays, solid quality, 90° opening
patentada, para bandejas GN, apertura 90°
brevetée, pour plateaux GN, ouverture 90°

	cm	↑ cm	GN		€
11008	53,0 x 32,5	19	1/1	vergoldeter Griff / gold plated handle pomo dorado / bouton doré	62,00
11010	53,0 x 32,5	19	1/1	verchromter Griff / chrome plated handle pomo cromado / bouton chromé	62,00
12008	32,5 x 26,5	15	1/2	vergoldeter Griff / gold plated handle pomo dorado / bouton doré	59,00
12010	32,5 x 26,5	15	1/2	verchromter Griff / chrome plated handle pomo cromado / bouton chromé	59,00



GN 1/1 Rolltophaube „SUNDAY“

GN 1/1 rolltop cover
GN 1/1 campana rolltop
GN 1/1 cloche rolltop



Griff ABS verchromt, leichtgängig auf- und zuklappbar
handle chrome plated, easy to open and close
asa material ABS cromado, fácil de abrir y cerrar
poignée matériel ABS chrome, ouverture et fermeture faciles

	cm	↑ cm	GN	€
11016	53,0 x 32,5	19	1/1	64,00



GN 1/1 Rolltophaube

GN 1/1 rolltop cover
GN 1/1 campana abatible
GN 1/1 cloche basculante



verchromter Zinkdruckguss-Griff / chrome plated metal handle / mango cromado de fundición a presión de zinc / poignée en zinc moulé sous pression chromé

	cm	↑ cm	GN	€
11018	53,0 x 32,5	19	1/1	64,00



Rolltophaube „FOCUS“

rolltop cover
campana abatible
cloche basculante



verchromter Griff / chrome plated handle / pomo cromado / bouton chromé

	cm	↑ cm	€
09013	44 x 33,5	17	28,00

ROLLTOP COVERS



Rolltophaube

rolltop cover
campana abatible
cloche basculante

glasklarer Kunststoff, leichtgängig auf- und zuklappen 90°

solid quality, to be opened 90°

plástico transparente, apertura 90°

plastique transparent résistant, ouverture 90°



	Ø cm	↑ cm		€
18388	38	20	mit verchromtem Kugelgriff / with chrome plated handle con pomo cromado / avec bouton chromé	24,00
18387	38	20	mit vergoldetem Kugelgriff / gold plated handle pomo dorado / bouton doré	24,00
09023	38	20	mit verchromtem Zylindergriff / chrome plated handle pomo cromado / bouton chromé	24,00
18380	50	26	mit verchromtem Zylindergriff / chrome plated handle pomo cromado / bouton chromé	62,00



Frischhaltehaube

cover
campana
cloche

schwere, glasklare Qualität

stable, crystal clear quality

calidad estable y transparencia cristalina

qualité stable et clarté cristalline



	Ø cm	↑ cm	fits to	€
06519	21	17	84941, 84942	30,00
06520	30	22	85034, 84177, 83891, 83890, 83884, 998, 975, 469, 468, 463, 462, 46	40,00
06521	36	27	84945, 84946	74,00



stapelbar
stackable



Präsentationsmöglichkeiten
presentation examples



SUPER DOME



Frischhaltehaube „SUPER DOME“

cover
campana
cloche

schwere, glasklare Qualität
stable, crystal clear quality
muy resistente y transparencia cristalina
haute résistance et transparence



	Ø cm	↑ cm	€
06525	30	40	74,00

passende Servier- Tortenplatten / suitable cake stands / porta pasteles compatibles /
présentoirs à gâteaux compatibles

	Ø cm	↑ cm	fits to	Farbe / Colour	€
00468	31,0	3,5	06525		18,40
33294	33,0	8,0	06525		70,00
33295	33,0	16,0	06525		96,00



Servierbeispiel
presentation example



Präsentationsmöglichkeiten
presentation examples



PLATE COVERS



Tellerabdeckhaube

plate cover
cubierta para plato
couvertcle pour assiette



passend für unterschiedliche Tellergrößen

suitable for different plate sizes
aptas para diferentes tamaños de platos
aptes pour différentes tailles d'assiettes

	Ø cm	↑ cm	passend für Tellergrößen / suitable for plate sizes	€
11051	22,0	7,0	Ø 21,5 cm	4,50
11052	24,0	7,5	Ø 22,5 - 23,0 cm	4,80
11053	28,0	6,5	Ø 26,0 - 26,5 cm	6,80
11054	28,5	6,5	Ø 27,0 - 27,5 cm	7,50



Servierbeispiele
presentation example



passende Hauben
suitable covers 11051, 11052



Frischhaltehaube

cover
campana
cloche bombée



glasklar, Griff verchromt, schwere, stabile Ausführung

transparent, chrome knob, heavy stable quality

transparente, asa cromada, alta estabilidad

transparente, anse chromée, très stable

	Ø cm	↑ cm	fits to	€
15350	16,5	10	15130	11,00
15351	20,5	10	15131, 15141, 15271	12,00



**Frischhaltehaube**

cover
campana
cloche

glasklar, schwere stabile Ausführung, stapelbar

clear, heavy stable quality, stackable
transparente, alta estabilidad, apilable
transparente, très stable, empilable



	Ø cm	↑ cm		€
06512	30	11,5	mit verchromtem Griff / with chrom plated handle con botón cromado / avec bouton chromé	8,20
06517	30	11,5	mit verchromtem Griff / with chrom plated handle con botón cromado / avec bouton chromé	9,60

**Frischhaltehaube**

cover
campana
cloche

glasklar, schwere stabile Ausführung, stapelbar

clear, heavy stable quality, stackable
transparente, alta estabilidad, apilable
transparente, très stable, empilable



	Ø cm	↑ cm		€
06510	30	11,5		5,90
06515	33	12,5		7,50



stapelbar
stackable

**Frischhaltehaube**

cover
campana
cloche



	Ø cm	↑ cm		€
06501	30	11		4,20
06504	30	9,5		6,40
06506	30	7		4,10

**Frischhaltehauben, 2er Set**

covers, 2 pcs. set
campanas, set de 2
cloches, pack de 2



	Ø cm	↑ cm		€
40752	30	11		7,80

COVERS



Frischhaltehaube

cover
campana
cloche



	Ø cm	↑ cm	fits to	€
11055	23	12	00827	6,00



Set 00827

glasklar, schwere stabile Ausführung
clear, heavy stable quality



Frischhaltehaube

cover
campana
cloche



	cm	↑ cm	fits to	€
11056	25 x 12	10	00828	6,00



Set 00828

glasklar, schwere stabile Ausführung
clear, heavy stable quality



06401

06701

Frischhaltehaube

cover
campana
cloche



	cm	↑ cm	€
06401	29,5 x 13,5	10	3,70
06701	21,6 x 16,2	7	2,80



18621

18121

Lieferung ohne Tablett | delivery without tray

Frischhaltehaube

cover
campana
cloche



	cm	↑ cm	€
18621	Ø 18	8,5	2,20
18121	35,5 x 27,8	7,5	6,20

FRIDA



... zu jeder Schale der
PASSENDE
DECKEL



84962 Ø 9 cm



84963 Ø 13 cm



84964 Ø 16 cm

Deckel „FRIDA“

cover
tapa
couvercle



	Ø cm	↑ cm	fits to	€
84962	9	2,5	84930, 84931	3,10
84963	13	2,5	84605, 84606	3,40
84964	16	2,5	84607, 84608	3,80



84931



84607



84608

84962
84931
84962
8493084963
84606

stapelbar / stackable



84965 13 x 13 cm



84966 17 x 17 cm



84967 18 x 16,5 cm



84968 18 x 11 cm

Deckel „FRIDA“

cover
tapa
couvercle



	cm	↑ cm	fits to	€
84965	13 x 13,0	2,5	84937, 84936	3,10
84966	17 x 17,0	2,5	84558, 84559	3,40
84967	18 x 16,5	2,5	84584, 84583	3,80
84968	18 x 11,0	2,5	84556, 84555	4,00



84937



84559



84558

84968
84556
84968
8455584967
84584

stapelbar / stackable



Deckel „FLOAT“ mit Löffelaussparung

cover, with notched for spoons
tapa, con espacio para la cuchara
couverture, avec encoche pour la louche



	cm	↑ cm	fits to	€
83920	Ø 20,5	1,3	00794, 83908, 83909, 85250, 85252	rund 9,20
83921	19 x 19	1,3	83916, 83917	eckig 8,40
83922	25 x 25	1,3	83918, 83919	eckig 10,60



Deckel „PURE“ mit Löffelaussparung

cover with notched for spoons
tapa con espacio para la cuchara
couverture avec encoche pour la louche



	cm	↑ cm	fits to	€
83600	19 x 19	1,5	79004, 79005, 83409, 83468, 84244, 85260, 85266	8,20
83601	25 x 25	1,5	83469, 83408, 84245, 84561, 84562, 85261, 85267	10,40



Deckel „PURE“, 5er Set

cover, 5 pcs.
tapa, set de 5
couverture, set de 5



Hygienischer Schutz für Ihre Speisen
• dichtschießend
• schwappsicherer Transport
protection for your food
• tightly closing
• slosh-proof transport

protección de alimentos
• con cierre hermético
• transporte sin salpicaduras
protection des aliments
• fermeture hermétique
• transport sans éclaboussures

	Ø cm	↑ cm	fits to	pcs.	€ / set
83603	13,0 x 13,0	0,5	83410, 83467	5	6,00
83604	19,5 x 19,5	0,5	79004, 79005, 83409, 83468, 84244, 84830, 85261, 85267	5	7,00



Deckel „CASUAL“, 5er Set

cover, 5 pcs. set
tapa, set de 5
couverture, set de 5



Hygienischer Schutz für Ihre Speisen
• dichtschießend
• schwappsicherer Transport
protection for your food
• tightly closing
• slosh-proof transport

protección de alimentos
• con cierre hermético
• transporte sin salpicaduras
protection des aliments
• fermeture hermétique
• transport sans éclaboussures

	Ø cm	↑ cm	fits to	pcs.	€ / set
83605	8,0	0,5	11866, 15400, 15416, 15461, 15462, 15467, 40655, 40656, 83881	5	3,60
83606	14,5	0,5	11865, 83700, 83701, 85104, 85105, 85107	5	6,00
83607	20,5	0,5	15404, 15420, 83704, 83705	5	7,00

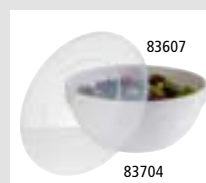

stapelbar
stackable



10890

Frischhaltedeckel

airtight cover
tapa hermética
couvercle hermétique



mit Silikondichtung, für luftdichtes Verschließen, Lebensmittel bleiben lange frisch

with silicone sealing ring, bowls closed airtight, to keep food fresh for a long time
junta de silicona para cerrar herméticamente y mantener los alimentos frescos más tiempo
joint de silicone pour fermeture hermétique et meilleure conservation des aliments

	Ø cm	fits to	€
10890	14	11865, 83700, 83701	10,40
10887	23	11846, 11848, 11875, 83702, 83703	19,00



zwei Öffnungspositionen des Deckels
two opening positions of the lid



11868

11878

Schutzdeckel mit Löffelaussparung

cover
tapa
couvercle



glasklar, klappbar, mit 10 Beschriftungsschildern

transparent, with 10 cards for inscription
plástico transparente, con 10 etiquetas para inscripción
plastique transparent, avec 10 étiquettes pour inscription

	Ø cm		€
11868	14,5	mit verchromtem Griff / chrome plated handle botón cromado / bouton chromé	12,00
11878	23,5	mit verchromtem Griff / chrome plated handle botón cromado / bouton chromé	12,60

Schilder, 10er Set / signs, 10 pcs. set / set de 10 cartelitos / set de 10 étiquettes

	fits to	€
12879	11868	4,90
11879	11878	5,20

**Deckel klappbar mit Löffelaussparung**

cover hinged
tapa con bisagra
couvercle avec charnière



glasklar, mit Designer-Griff, verchromt, ohne Beschriftungsschild

clear, with designer handle, chrome plated, without card for inscription
transparente, con pomo de diseño cromado, sin tarjetas para inscripción
transparent, avec bouton chromé de design, sans étiquette pour inscription

	Ø cm	fits to	€
10889	23,5	11817, 11818, 11845, 11847, 11849	12,00



11875

Schale

bowl
cuenco
bol



	Ø cm	↑ cm	litr.	VE / unit	€ / pc.
11859	6,0	2,5	0,05	36	1,80
11866	7,5	3,5	0,09	36	1,90
11865	14,0	6,5	0,50	6	3,00
11875	23,0	10,5	2,50	6	6,40

COOLERS



Kühlakku

cooler
acumulador de frío
accumulateur de froid



gefüllt mit Kühlflüssigkeit, nicht giftig, einfach im Gefrierfach einfrieren, unbegrenzt wiederverwendbar

freeze it in freezer, non toxic, filled with freezer-liquid, boundless reusable
se enfría en el congelador, no tóxico, se puede reutilizar sin límite
liquide eutectique qui accumule froid une fois dans le congélateur, non toxique, réutilisable sans limites

	Ø cm	↑ cm	Farbe / Colour	€
10777	15	2,5	■	5,40
10781	10,5	2,5	■	3,10
10661	10,5	2,0	■	3,40



Kühlakku

cooler
acumulador de frío
accumulateur de froid



	Ø cm	→ cm	Farbe / Colour	€
00615	7,5	11,5	■	10,50



Kühlakku

cooler
acumulador de frío
accumulateur de froid



gefüllt mit Kühlflüssigkeit, nicht giftig, einfach im Gefrierfach einfrieren, unbegrenzt wiederverwendbar

freeze it in freezer, non toxic, filled with freezer-liquid, boundless reusable
se enfría en el congelador, no tóxico, se puede reutilizar sin límite
liquide eutectique qui accumule froid une fois dans le congélateur, non toxique, réutilisable sans limites

	cm	↑ cm	Farbe / Colour	€
10782	41 x 21	2,5	■	16,00
10791	25 x 19	2,5	■	7,90
11101	16 x 7,5	2,0	■	4er Set / 4 pieces set / set de 4 / set de 4 6,60



Aufsteller „ACHTUNG RUTSCHGEFAHR“

stand
letrero
panneau



	cm	↑ cm	Farbe / Colour	€
71421	30 x 63	63	■	8,90

NEW

Der nachhaltige Mehrwegbecher – made in Germany



eco-friendly

400 ml



Das Ribbendesign isoliert die Hitze – kein „Verbrennen“ der Finger möglich

The rib design insulates the heat - no „burning“ of the fingers possible

Mehrwegbecher individuell mit Ihrem Logo/Namen herstellbar ab 500 Stck. – sprechen Sie uns an!

Reusable cups can be individually produced with your logo/name. From 500 pieces - please contact us!

- ✓ aufsteckbarer Deckel mit Trinköffnung
- ✓ 100% recyclebar
- ✓ spülmaschinengeeignet
- ✓ stapelbar mit und ohne Deckel
- ✓ schwappsicher

- clip-on lid with drinking opening
- 100% recyclable
- dishwasher safe
- stackable with and without lid
- slosh-/leak-proof



NEW

To Go Mehrwegbecher

To Go reusable cup
vaso reutilizable To Go
tasse réutilisable To Go
Becher (ohne Deckel)
cup (without cover)
vaso (sin tapa)
tasse (sans couvercle)



	Ø cm	↑ cm	ltr.	Farbe / Colour	VE / unit	€/ pc.
66910	8,5	13,5	0,4		48	2,00
66911	8,5	13,5	0,4		48	2,00
66912	8,5	13,5	0,4		48	2,00
66913	8,5	13,5	0,4		48	2,00

Deckel / cover / tapa / couvercle

	Ø cm	↑ cm	Farbe / Colour	VE / unit	€/ pc.
66914	8,5	2,5		48	1,00
66915	8,5	2,5		48	1,00
66916	8,5	2,5		48	1,00
66917	8,5	2,5		48	1,00

*Laser-Logo
Individual*

Laserlogo Individual

- perfekte Lasergravuren
- perfectly Laser engravings
- grabado perfecto por láser
- marcage laser parfait



DE

- unverwechselbar
- einzigartig
- imagefördernd

Ihre individuelle Lasergravur von APS

Wir bieten Ihnen die Möglichkeit, unsere Produkte mit Ihrem individuellen Logo per Laser zu gravieren - einzigartig, unverwechselbar und bereits ab 10 Stück je Artikel. Die perfekte Beschriftung durch modernste Lasertechnologie ist spülmaschinenfest und somit dauerhaft auf allen Edelstahl- und Naturschieferprodukten, sowie auf versilberten und verchromten Metall-Artikeln umsetzbar. Machen Sie aus Ihren Gastronorm-Behältern Ihre ganz persönlichen Unikate und werten Sie Ihre Servierartikel mit Ihrem eigenen Logo auf.

- geringe Mindestbestellmenge von nur 10 Stück
- kurze Lieferzeiten
- Logos bis zu einer Fläche von max. 10 x 10 cm realisierbar

ES

- único
- personalizado
- promotor de imagen

Grabado laser por APS

Podemos grabar su logo y así personalizar los productos APS a partir de mínimo 10 unidades por referencia. Gracias a la novedosa tecnología de grabado por láser, la inscripción es perfecta y resistente al lavavajillas. Se puede aplicar a los artículos en acero inoxidable, pizarra natural, metal cromado y plateado.

- cantidad mínima de solamente 10 unidades
- realización rápida
- tamaño de logos hasta máximo 10 x 10 cm

EN

- distinct
- unique
- image enhancing

Your individualised laser engraving by APS

We offer you the option of having your personalised logo engraved on our products - inimitable, unique, and available for delivery from only 10 pieces per product. The perfect inscription by use of the newest technology is dishwasher-safe and thus can be permanently applied to products made of stainless steel and natural slate, as well as silver-coated and chromed metal articles. Turn your gastronorm container into your individual, one of a kind article and enhance your serving items with your own logo.

- minimum order quantity of only 10 pieces
- swift delivery
- feasible logos are those with a maximum size of 10 x 10 cm

FR

- unique
- original
- porteur d'image

Marcage laser par APS

Nous pouvons graver votre logo et ainsi personnaliser les produits APS à partir de 10 pièces par référence. Grâce à une technologie d'avant-garde de marquage par laser, l'inscription est parfaitement reproduite et résistante au lave-vaisselle. Ce type de marquage peut s'appliquer sur l'acier inoxydable, sur l'ardoise naturelle, sur le métal chromé ou argenté.

- quantité minimum de seulement 10 unités
- fabrication rapide
- taille du logo jusque 10 x 10 cm



APS - BSCI-Mitglied

APS engagiert sich für die Verbesserung von Arbeitsbedingungen.

Wir sind Partner der europäischen Organisation BSCI. Die "Business Social Compliance Initiative" (BSCI) ist eine Initiative von Unternehmen zur Verbesserung der Arbeitsbedingungen in der globalen Versorgungskette.



APS is a member of BSCI

APS is committed to the improvement of working conditions.

We are a partner of the European organization BSCI. The "Business Social Compliance Initiative" is an initiative of enterprises to improve working conditions in the global supply chain.

APS Melamin - Garantierte Qualität

APS-Melaminprodukte entsprechen den Richtlinien (EG) 1935/2004 und (EU) 10/2011 der Europäischen Kommission. Diese enthalten Bestimmungen für Materialien aus Kunststoffen, welche mit Lebensmitteln in Berührung kommen. Wir arbeiten sehr eng mit Zertifizierungsinstitutionen und Prüflaboren zusammen und können somit die Lebensmittelsicherheit (LFGB Regulation) der APS-Melaminartikel garantieren.

APS Melamine - Guaranteed quality

APS melamine products comply with directives (EG) 1935/2004 and (EU) 10/2011 of the European Commission. This contain provisions for plastic materials which come into contact with foodstuffs. We work very closely together with certification institutions and testing laboratories and are therefore able to guarantee the compatibility with foodstuffs (German LFGB regulation) of APS melamine.

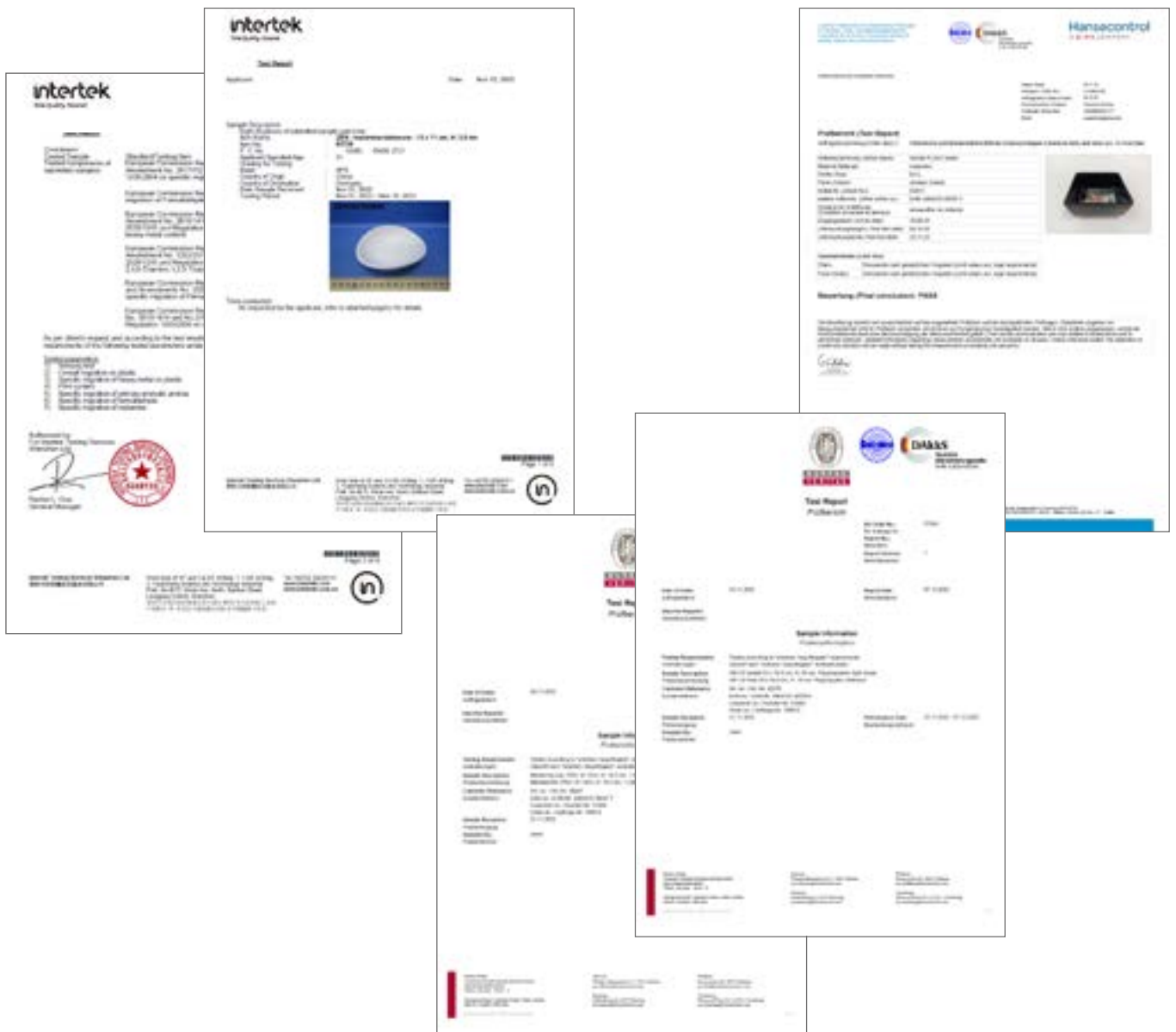



Icon-Index

	neuer Artikel new item		spülmaschinengeeignet dishwasher-proof		für Induktionsplatten for induction use		max. 70°C
	GN-Größen GN norm		nicht spülmaschinen-geeignet not dishwasher-proof		feucht abwaschbar wet washable		kühlbar for cooling
	Made in Germany		Made in the EU		bruchsicher shatter-proof		nicht für Lebensmittelkontakt not food safe
	mikrowellengeeignet microwave-proof		Antirutsch-Füßchen non-slip feet		stapelbar stackable		Eigenmontage self assembly
	nicht mikrowellen-geeignet not microwave-proof		nicht für Backofen not for baking oven		keine direkte Hitze not direct heat		

Material-Index

 **Edelstahl 18/10**
Werkstoff 1.4301; rostfrei; langlebig; gute isolierende Eigenschaften; absolut hygienisch und nicht toxisch; recyclebar; nicht resistent gegen dauerhaften Kontakt mit Chloriden und Säuren (z. B. Kochsalz und Fruchtsäuren); sterilisierbar; Oberfläche lässt sich vielfältig polieren; nicht magnetisch; Gebrauchstemperatur bis ca. 400 °C
Pflege
pflegeleicht; maschinell oder per Hand mit milden Spülmitteln; möglichst keine Stahlwolle u. ä. verwenden; nach Erhitzung Schockabkühlung vermeiden

 **Edelstahl (unspezifisch)**
niedrig nickelhaltige Edelstähle wie 14/4; nicht magnetisch; geringere allgemeine Resistenz als Edelstahl 18/10;
Pflege:
pflegeleicht; maschinell oder per Hand mit milden Spülmitteln; möglichst keine Stahlwolle u. ä. verwenden; nach Erhitzung Schockabkühlung vermeiden

 **Edelstahl 18/0**
Werkstoff 1.4016; rostfrei; langlebig bei entsprechender Pflege; absolut hygienisch und nicht toxisch; gut härtbar, daher idealer Stahl für Tafelmesser, Tabletts, Schneidwerkzeuge u. ä.; lässt sich hochglanzpolieren; für Nickelallergiker geeignet; magnetisch; nicht so chemikalienresistent wie Edelstahl 18/10; Gebrauchstemperatur bis ca. 400 °C
Pflege:
maschinell oder per Hand mit milden Spülmitteln; Ablagerungen von Kalk und Reinigerresten nach dem Spülen unbedingt entfernen; niemals mit Stahlwolle reinigen

 **Eisen**
nicht rostfrei; charakteristische, strukturierte Oberfläche mit unterschiedlichen Schattierungen; durch wiederholten Schmiedevorgang ist das Material stark verdichtet und sehr hart; langlebig bei entsprechender Pflege
Pflege:
vor erstem Einsatz mit Öl und Kartoffelschalen „einbraten“; später nach jeder Reinigung einfetten; stets trocken lagern

Stainless steel 18/10
Material 1.4301; stainless; durable; good insulating properties; absolutely hygienic and non-toxic; recyclable; not resistant to permanent contact with chlorides and acids (e.g. table salt and fruit acids); sterilisable; surface can be polished in many ways; non-magnetic; service temperature up to approx. 400 °C
Care
easy to clean; machine or hand wash with mild detergents; if possible, do not use steel wool or similar; Avoid shock cooling after heating.

Stainless steel (unspecific)
Stainless steel with low nickel content such as 14/4; non-magnetic; lower general resistance than 18/10 stainless steel
Care:
easy to clean; machine or hand wash with mild detergents; if possible, do not use steel wool or similar; Avoid shock cooling after heating.

Stainless steel 18/0
Material 1.4016; stainless; long-lasting with appropriate care; absolutely hygienic and non-toxic; good hardening properties, therefore ideal steel for table knives, trays, cutting tools, etc.; can be polished to a high gloss; suitable for people allergic to nickel; magnetic; not as resistant to chemicals as stainless steel 18/10; service temperature up to approx. 400 °C
Care:
by machine or by hand with mild detergents; Remove limescale and detergent residues after cleaning; never clean with steel wool

Iron
not rustproof; characteristic, structured surface with different shades; due to repeated forging process, the material is strongly compressed and very hard; long-lasting with appropriate care,
Care:
before first use, fry with oil and potato peelings; later grease after each cleaning; always store in a dry place.



Gusseisen

langlebig bei entsprechender Pflege; geeignet für alle Herdarten (inkl. Induktion); speichert lange Wärme und gibt sie gleichmäßig ab; absolut hygienisch bei unbeschädigter Oberfläche; relativ schweres Material; Überhitzung fast nicht möglich; nicht schlagfest; magnetisch



Pflege:

nach Gebrauch sofort mit heißem Wasser reinigen; bei Fleckenbildung mit Essig nachreinigen; niemals mit Stahlwolle reinigen; milde Spülmittel verwenden; stets trocken lagern



Versilberter Stahl

Edelmetallüberzug; nicht völlig säurefest; nicht über längere Zeit Sonnenlicht aussetzen

Pflege:

niemals scheuernde Hilfsmittel verwenden; nur mit weichem Lappen und Spezialmitteln reinigen; keine Spülmaschinenreinigung!



Verchromter Stahl

nichtedles Metall mit hartem Chromüberzug; nicht säurefest; nach Beschädigung der Chromschicht kein Schutz gegen Umwelteinflüsse

Pflege:

niemals scheuernde Hilfsmittel verwenden; nur mit weichem Lappen



Aluminium

sehr leichtes Material; sehr gute elektrische und thermische Leitfähigkeit; korrosionsbeständig; Gebrauchstemperatur bis ca. +500 °C

Pflege:

niemals scheuernde Hilfsmittel verwenden; nur mit weichem Lappen und Spezialmitteln reinigen; keine Spülmaschinenreinigung!

Cast Iron

Long-lasting with appropriate care; suitable for all types of cookers (incl. induction); stores heat for a long time and releases it evenly; absolutely hygienic with undamaged surface; relatively heavy material; overheating is almost impossible; not impact-resistant; magnetic

Care:

clean immediately with hot water after use; clean with vinegar if stains form; never clean with steel wool; use mild detergents; always store in a dry place

Silver plated steel

Metal coating; not completely acid-resistant; do not expose to sunlight for long periods of time

Care:

never use abrasive cleaners; clean only with a soft cloth and special cleaning agents; not suitable for dishwashers

Chrome plated steel

Metal with hard chrome coating; not acid-resistant; after damage to the chrome layer no protection against environmental influences

Care:

never use abrasive cleaners; only with a soft cloth

Aluminium

Very light material; very good electrical and thermal conductivity; corrosion-resistant; service temperature up to approx. +500 °C

Care:

never use abrasive cleaners; clean only with a soft cloth and special cleaning agents; not suitable for dishwashers



ABS – Acrylnitril-Butadien-Styrol

sehr gute Oberflächenhärte; temperaturwechselfest; Gebrauchstemperatur bis ca. +100 °C

Pflege:

spülmaschinengeeignet

ABS - acrylonitrile butadiene styrene

very good surface hardness; resistant to temperature changes; service temperature up to approx. +100 °C

care:

dishwasher safe



ACRYL – künstliches Harz

farblos; glasartig; durchsichtig; nicht splinternd; chemisch modifiziert als Plexiglas®; Gebrauchstemperatur ca. -40 °C bis ca. +50 °C

wichtiger Pflegehinweis:

nur handelsübliche Acrylspezialreiniger oder milde alkohol- und ammoniakfreie Reinigungsmittel verwenden; nicht spülmaschinengeeignet;

ACRYL - artificial resin

colourless; glass-like; transparent; not splintering; chemically modified as Plexiglas®; service temperature approx. -40 °C to approx. +50 °C

important care advice:

use only commercially available acrylic special cleaners or mild and ammonia-free cleaning agents; not suitable for dishwashers



EVA - Ethylenvinylacetat

weich elastisch; glänzend; Gebrauchstemperatur bis ca. +60 °C

Pflege:

abwaschbar / wasserfest

EVA - ethylene vinyl acetate

soft elastic; glossy; service temperature up to approx. +60 °C

care:

washable / waterproof



GFK – Glasfaserverstärkter Kunststoff

starr; nahezu unzerbrechlich; Gebrauchstemperatur bis ca. +100 °C

Pflege:

spülmaschinengeeignet

GFK - glass-fibre reinforced plastic

rigid; almost unbreakable; service temperature up to approx. +100 °C

care:

dishwasher-safe



MF - Melamin

sehr hart; stoß- und kratzfest; hygienisch; Gebrauchstemp. ca. -30 °C bis +70 °C

Pflege:

säurebeständig; spülmaschinengeeignet

MF - melamine

very hard; impact- and scratch-resistant; hygienic; service temp. approx. -30 °C to +70 °C

care:

acid-resistant; dishwasher safe



MS - Kunststoff

farblos; glasartig; durchsichtig; Gebrauchstemperatur ca. 0 °C bis ca. +70 °C

Pflege:

nicht spülmaschinengeeignet

MS - plastic

colourless; glass-like; transparent; service temperature approx. 0 °C to +70 °C

care:

not dishwasher-safe



PA - Polyamid

starr; bruch- und schlagfest; mattglänzend; Gebrauchstemperatur bis ca. +220 °C

Pflege:

spülmaschinengeeignet

PA - polyamide

rigid; break- and impact-resistant; matt glossy; service temperature up to approx. +220 °C

care:

dishwasher-safe

**PC - Polycarbonat**

starr; nahezu unzerbrechlich; sehr stabil; formbeständig in kochendem Wasser; mikrowelleneeignet; Gebrauchstemperatur ca. -30 °C bis ca. +100 °C
 Pflege:
 spülmaschineneeignet

PC - polycarbonate

rigid; almost unbreakable; very stable; keeps its shape in boiling water; microwave safe; service temperature approx. -30 °C to approx. +100 °C
 care:
 dishwasher-safe

**PE - Polyethylen / HDPE – hochdichtes Polyethylen**

hart elastisch; unzerbrechlich; ausreichend formbeständig in heißem Wasser; glänzend; Gebrauchstemperatur ca. -30 °C bis ca. +120 °C
 Pflege:
 spülmaschineneeignet

PE - polyethylene / HDPE - high-density polyethylene

hard elastic; unbreakable; sufficiently dimensionally stable in hot water; shiny; service temperature approx. -30 °C to approx. +120 °C
 care:
 dishwasher safe

NDPE – niederdichtes Polyethylen

weich elastisch; unzerbrechlich; kurzzeitig formbeständig in heißem Wasser; nicht glänzend; Gebrauchstemperatur ca. -30 °C bis ca. +95 °C
 Pflege:
 spülmaschineneeignet

NDPE - low density polyethylene

soft elastic; unbreakable; briefly keeps its shape in hot water; not shiny; service temperature approx. -30 °C to approx. +95 °C
 care:
 dishwasher safe

**PET - Polyethylenterephthalat**

hart elastisch; ausreichend formbeständig in heißem Wasser; glänzend; Gebrauchstemperatur ca. -30 °C bis ca. +55 °C
 Pflege:
 spülmaschineneeignet bis 55°C

PET - Polyethylene terephthalate

hard elastic; sufficiently dimensionally stable in hot water; shiny; service temperature approx. -30 °C to approx. +55 °C
 care:
 dishwasher safe up to 55°C

**PP - Polypropylen**

hart elastisch; unzerbrechlich; umweltschonend recycelbar; mikrowelleneeignet; Gebrauchstemperatur ca. -30 °C bis ca. +75 °C
 Pflege:
 spülmaschineneeignet

PP - polypropylene

hard elastic; unbreakable; environmentally friendly recyclable; microwave safe; service temperature approx. -30 °C to approx. +75 °C
 care:
 dishwasher safe

**PS - Polystyrol**

starr; kratzfest; formbeständig in kochendem Wasser; Gebrauchstemperatur bis ca. +70 °C
 Pflege:
 spülmaschineneeignet

PS - polystyrene

rigid; scratch-resistant; keeps its shape in boiling water; service temperature up to approx. +70 °C
 care:
 dishwasher safe

**PVC - Polyvinylchlorid**

säurebeständig; schwer entflammbar; Gebrauchstemperatur ca. -50 °C bis +60 °C
 Pflege:
 nicht spülmaschineneeignet

PVC - polyvinyl chloride

acid-resistant; flame-retardant; service temperature approx. -50 °C to +60 °C
 care:
 not dishwasher safe

**SAN - Styrol-Acrylnitril**

gute Oberflächenhärte; temperaturwechselfest; Gebrauchstemperatur bis ca. +100 °C
 Pflege:
 spülmaschineneeignet

SAN - styrene acrylonitrile

good surface hardness; resistant to temperature changes; service temperature up to approx. +100 °C
 care:
 dishwasher safe

**Silikon**

hohe thermische Beständigkeit; gute Kälteflexibilität; Gebrauchstemp. ca. -70 °C bis ca. +180 °C
 Pflege:
 spülmaschineneeignet

Silicone

high thermal resistance; good low-temperature flexibility; service temperature approx. -70 °C to approx. +180 °C
 care:
 dishwasher safe

**Tritan®**

starr; unzerbrechlich; absolut formbeständig; sehr hohe Chemikalienbeständigkeit; Gebrauchstemperatur ca. -30 °C bis ca. +95 °C; nicht mikrowelleneeignet
 Pflege:
 spülmaschineneeignet

Tritan®

rigid; unbreakable; keeps its shape in boiling water; very high chemical resistance; service temperature approx. -30 °C to approx. +95 °C; not microwaveable
 care:
 dishwasher safe

BETON
CONCRETE

Beton

Werkstoff Beton, coole optik; handgefertigt
Pflege:
nicht spülmaschinengeeignet

PORZELAN
PORCELAIN

Porzellan

hitzebeständig bis ca. +220 °C
Pflege:
spülmaschinengeeignet

SCHIEFER
SLATE

Schiefer

Naturschiefer versiegelt; lebensmittelecht;
Pflege:
nicht spülmaschinengeeignet

KUNST
FASER
TETRON

Tetron

Kunstfaser: 65% Polyester, 35% Viskose
Pflege:
Maschinenwaschbar bis 30 grad

Concrete

Concrete material, cool look; handmade
care:
not dishwasher safe

Porcelain

heat-resistant up to approx. +220 °C
care:
dishwasher safe

Slate

Natural slate sealed; food-safe
care:
not dishwasher safe

Tetron

Artificial fibre: 65% polyester, 35% viscose
care:
Machine washable up to 30 degrees

HOLZ
WOOD

Holz

lebensmittelecht; nicht spülmaschinengeeignet; naturbedingte Abweichung in Form, Farbe, Maserung und Größe; Abweichungen stellen keinen Mangel dar

Pflege:

Direkt nach dem Gebrauch sollten Holzprodukte abgespült und mithilfe einer Spülbürste gereinigt werden. Auch Spülmittel dürfen zur Reinigung verwendet werden. Wir empfehlen auf beiden Seiten zu spülen, damit im Holz keine Spannungen durch einseitige Befeuchtung entstehen. Danach gut abtrocknen und die restliche Feuchtigkeit auf einem Tuch abtropfen lassen. So können die Produkte gleichmäßig von beiden Seiten trocknen. Weichen Sie das Holzschneidbrett nicht ein und lassen Sie es auch nicht im Wasser liegen. Auch nicht in Ofennähe trocknen lassen.

Wie kann man Holzprodukte ölen?

Nicht nur die Reinigung spielt für die Produkte eine wichtige Rolle, sondern auch die Aufrechterhaltung seiner Kondition. Mit ein wenig Öl lässt sich beim Holz daher jede Menge erreichen, denn wird die Oberfläche mit Öl eingerieben, kommt es zur Schließung der Poren.

Beim Ölen sollte allerdings darauf geachtet werden, dass es sich um ein geschmacksneutrales oder geruchloses Öl handelt. Empfehlenswert sind hierbei entweder Traubenkernöl oder auch Mandelkernöl. Vorsicht: sollte man unter einer Nussallergie leiden, ist von der Benutzung des Mandelöls abzuraten). Sie können fast jedes Salatöl verwenden. Dabei gilt die Grundregel: je höher raffiniert umso besser, da es dadurch nicht so leicht ranzig wird. Ein weiteres Öl, das verwendet werden kann, ist Weissöl aus der Apotheke. Auf Olivenöl sollte verzichtet werden, denn dann kann das Brett ranzig riechen und verkleben.

So geht's: Tröpfeln Sie etwas Öl auf das Schneidbrett und verreiben Sie es gleichmäßig auf allen Seiten.

Wood

food-safe; not dishwasher-safe; natural deviation in shape, colour, grain and size; deviations do not constitute a defect

Care:

Immediately after use, wooden products should be rinsed and cleaned with a dishwashing brush. Washing-up liquid may also be used for cleaning. We recommend rinsing on both sides so that no tensions arise in the wood due to one-sided moistening. Then dry well and let the remaining moisture drip off on a cloth. This allows the products to dry evenly from both sides. Do not soak the wooden chopping board or leave it in water. Also do not let it dry near the oven.

How to oil wooden products?

Not only cleaning plays an important role for the products, but also maintaining its condition. A little oil can therefore achieve a lot with wood, because if the surface is rubbed with oil, the pores are closed.

When oiling, however, care should be taken that the oil is tasteless or odourless. Grape seed oil or almond seed oil are recommended. Caution: if you suffer from a nut allergy, it is not advisable to use almond oil. You can use almost any salad oil. The basic rule is: the more highly refined the better, as this makes it less likely to go rancid. Another oil that can be used is white oil from the pharmacy. Olive oil should be avoided, because then the board can smell rancid and stick together.

How to do it: Drip some oil onto the chopping board and rub it evenly on all sides.



Index

Artikel-Nr.	Prüfziffer	Seite															
0																	
00011	7	300	00311	8	296	00568	6	428	00687	4	447	00805	2	129	00914	1	91
00012	4	300	00381	1	101	00570	9	428	00688	1	447	00806	9	89, 129	00937	0	115, 249
00013	1	304	00382	8	101	00572	3	304	00691	1	240	00807	6	129	00941	7	113, 250
00016	2	295	00383	5	101	00574	7	430	00692	8	240	00808	3	122, 249	00942	4	113, 250
00017	9	304	00384	2	101	00576	1	430	00693	5	240	00809	0	123	00945	5	113, 250
00018	6	295	00385	9	101	00578	5	429	00694	2	470	00810	6	120, 244	00947	9	114, 249
00019	3	295	00388	0	101	00580	8	431	00695	9	470	00811	3	120, 244	00953	0	88
00020	9	295	00389	7	108	00581	5	426	00696	6	470	00812	0	120, 244	00954	7	88
00021	6	300	00391	0	108	00582	2	427	00697	3	470	00813	7	120, 244	00955	4	89, 130
00022	3	298	00392	7	108	00583	9	427	00699	7	240, 453	00814	4	120, 244	00956	1	89, 130
00023	0	300	00393	4	108	00584	6	427	00700	0	301	00816	8	129	00957	8	89, 130
00025	4	295	00394	1	108	00585	3	427	00711	6	440	00817	5	123	00958	5	84
00026	1	295	00395	8	108	00586	0	429	00712	3	440	00818	2	122, 134, 288	00959	2	88
00027	8	296	00396	5	108	00587	7	439	00713	0	440	00820	5	107	00960	8	87, 116
00029	2	296	00397	2	108	00588	4	438	00714	7	440	00821	2	107	00966	0	112
00030	8	301	00398	9	108	00589	1	438	00715	4	440	00822	9	107	00968	4	115
00031	5	296	00399	6	108	00590	7	438	00716	1	440	00825	0	107	00969	1	115
00032	2	270	00401	6	276	00591	4	438	00721	5	440	00826	7	107	00971	4	114, 250, 256
00033	9	267, 417	00463	4	135, 289	00592	1	439	00722	2	440	00827	4	104	00973	8	24, 113
00036	0	301	00468	9	136, 216, 288, 290, 489	00593	8	439	00723	9	440	00828	1	104	00975	2	115
00037	7	299	00469	6	216, 288	00594	5	439	00730	7	440	00830	4	94, 107	00979	0	28, 112, 113
00040	7	469	00500	6	131, 423	00595	2	438	00740	6	462	00831	1	442	00984	4	116, 250
00042	1	469	00502	0	132, 424	00596	9	439	00744	4	462	00832	8	442	00986	8	114, 249
00046	9	135, 289	00506	8	131, 423	00597	6	439	00745	1	462	00833	5	442	00987	5	114, 249
00047	6	135, 289	00508	2	132, 424	00598	3	439	00746	8	462	00834	2	442	00988	2	113, 250
00048	3	430	00510	5	131, 423	00599	0	455	00747	5	462	00835	9	125, 248	00989	9	87, 116
00050	6	430	00511	2	131, 423	00600	3	444	00750	5	124, 247	00840	3	454	00990	5	24, 113
00052	0	428	00515	0	131, 423	00601	0	445	00751	2	124, 247	00841	0	454	00991	2	24, 113
00054	4	428	00521	1	132, 424	00602	7	445	00752	9	124, 247	00842	7	454	00992	9	113
00056	8	428	00522	8	132, 424	00603	4	444	00753	6	124, 247	00843	4	127, 241	00993	6	24, 113
00060	5	302	00524	2	132, 424	00604	1	444	00754	3	125, 248	00844	1	127, 241	00994	3	113, 250
00063	6	270	00525	9	132, 424	00605	8	445	00755	0	125, 248	00845	8	243	00995	0	113, 250
00064	3	105	00526	6	132, 424	00606	5	445	00756	7	125, 248	00846	5	129, 243	00996	7	113, 250
00065	0	105	00528	0	132, 424	00607	2	445	00757	4	125, 248	00864	9	128, 245	00997	4	116
00067	4	105	00529	7	132, 424	00610	2	470, 481	00758	1	117	00867	0	121, 244	00998	1	115
00069	8	73, 304	00530	3	133, 425	00611	9	470, 481	00759	8	117	00868	7	121, 244	00999	8	115
00070	4	299	00531	0	133, 425	00612	6	470, 481	00760	4	118	00869	4	121, 244	01000	0	106, 115
00071	1	303	00532	7	133, 425	00615	7	56, 410, 496	00761	1	125, 246	00870	0	121, 243	01010	9	127, 241
00074	2	301	00533	4	133, 425	00617	1	56, 410, 413	00765	9	269, 416	00871	7	121, 243	01011	6	127, 241
00075	9	101	00534	1	133, 425	00618	8	56, 410	00766	6	267, 417	00873	1	121, 243	01012	3	127, 241
00076	6	300	00535	8	133, 425	00619	5	56, 410	00768	0	267, 269, 416, 417	00874	8	121, 243	01013	0	128, 242
00077	2	301	00536	5	133, 425	00620	1	56, 410	00771	0	464	00875	5	121, 243	01014	7	128, 242
00078	0	302	00537	2	133, 425	00621	8	56, 410	00772	7	258, 465	00876	2	121, 243	01015	4	128, 242
00079	7	302	00538	9	133, 425	00623	2	287	00773	4	258	00877	9	121, 243	01016	1	126, 243
00081	0	101	00539	6	133, 425	00625	6	287	00774	1	258	00878	6	128, 246	01017	8	126, 243
00082	7	101	00540	2	133, 425	00626	3	287	00775	8	258	00880	9	126	01018	5	455
00084	1	101	00541	9	133, 425	00627	0	287	00776	5	258	00881	6	126	01019	2	455
00085	8	101	00542	6	133, 425	00634	8	269, 416	00777	2	258	00882	3	126	01020	8	454
00087	2	101	00543	3	133, 425	00636	2	64	00778	9	258	00883	0	89, 130	01021	5	242
00090	2	429	00547	1	131, 423	00637	9	65	00779	6	258, 465	00884	7	89, 130	01022	2	242
00091	9	429	00548	8	131, 423	00650	8	351	00780	2	465	00885	4	89, 130	01023	9	127, 242
00092	6	468	00549	5	131, 423	00652	2	105, 136	00781	9	258	00886	1	89, 130	01024	6	241
00093	3	468	00552	5	133, 425	00662	1	443	00782	6	258	00887	8	121, 244	01025	3	241
00094	0	468	00553	2	133, 425	00664	5	443	00783	3	258	00897	7	120, 245	01026	0	248, 455
00098	8	468	00554	9	133, 425	00666	9	443	00785	7	465	00898	4	120, 245	01309	4	103
00099	5	468	00555	6	133, 425	00668	3	443	00790	1	119, 245	00899	1	120, 245	01310	0	103
00106	0	469	00560	0	427	00670	6	443	00791	8	119, 245	00905	9	122, 242	01311	7	103
00110	7	468	00561	7	292, 427	00671	3	440	00792	5	119, 245	00906	6	122, 242	01312	4	103
00113	8	468	00562	4	427	00672	0	440	00793	2	119, 245	00907	3	127, 242	01313	1	103
			00563	1	427	00673	7	440	00794	9	69	00908	0	127, 242	01314	8	103
			00564	8	427	00677	5	240	00795	6	69	00910	3	91	01317	9	103
						00685	0	447	00796	3	69	00911	0	89, 91, 130	01318	6	103
						00686	7	447				00912	7	91	01322	3	103

01323	0	103	09091	0	35	10503	4	386	10708	3	42	10840	0	46	11044	1	75, 100, 166, 188, 324, 484
01324	7	103	09093	4	35	10504	1	386	10709	0	42	10849	3	36, 383	11048	9	100
01325	4	103	09094	1	35	10505	8	38, 387	10710	6	42	10850	9	46	11051	9	490
01332	2	103	09099	6	106	10506	5	240, 434	10711	3	42	10851	6	37, 39, 384	11052	6	490
01335	3	103	09100	9	34	10509	6	387	10712	0	42	10853	0	37, 384	11053	3	490
01338	4	103	09102	3	34	10510	2	387	10713	7	42	10855	4	38	11054	0	490
01348	3	103	09104	7	34	10511	9	387	10714	4	42	10859	2	46	11055	7	422, 492
01349	0	103	09200	6	34	10512	6	387	10715	1	42	10870	7	20, 45	11056	4	83, 186, 422, 492
01699	6	106, 271	09202	0	34	10513	3	386	10716	8	42	10871	4	20, 45	11065	6	100
01709	2	103	09204	4	34	10514	0	386	10717	5	42	10872	1	20, 45	11070	0	316, 318, 486
01710	8	103				10515	7	386	10718	2	37, 38, 384	10873	8	20, 45	11071	7	316, 318, 486
01711	5	103	1			10516	4	386	10720	5	41	10887	5	19, 495	11072	4	316, 318, 486
01712	2	103	10316	0	267, 417	10517	1	386	10721	2	51	10889	9	495	11073	1	117, 486
01738	2	103	10318	4	416	10520	1	52	10722	9	51	10890	5	19, 495	11074	8	486
01748	1	103	10319	1	416	10525	6	387	10738	0	51	10907	0	46	11075	5	25, 28, 112, 117, 487
02038	2	296	10320	7	416	10526	3	387	10739	7	51	10910	0	49	11100	4	29, 100
02039	9	296	10321	4	269, 416	10527	0	387	10741	0	51	10911	7	49	11101	1	29, 30, 34, 496
02310	9	102	10322	1	415	10528	7	387	10742	7	51	10912	4	49	11110	3	100
02311	6	102	10323	8	415	10529	4	387	10748	9	53	10913	1	49	11118	9	15
02312	3	102	10325	2	415	10530	0	387	10749	6	53	10914	8	49	11119	6	15, 204
03038	1	274	10326	9	415	10531	7	387	10750	2	45	10915	5	47	11150	9	99
03039	8	274	10327	6	415	10532	4	387	10756	4	46	10916	2	47	11155	4	99
03098	5	274	10328	3	414	10533	1	387	10757	1	46	10917	9	47	11244	5	348
03099	2	274	10329	0	414	10534	8	387	10758	8	46	10921	6	48	11295	7	99
03622	2	97, 217	10330	6	414	10535	5	387	10759	5	46	10922	3	48	11300	8	99
03623	9	97, 217	10331	3	414	10536	2	387	10762	5	50	10923	0	48	11305	3	99, 484
03824	0	101	10332	0	414	10560	7	385	10764	9	50	10924	7	48	11442	5	95
04010	6	275	10334	4	414	10561	4	385	10766	3	50	10925	4	48	11444	9	95
04011	3	275	10335	1	414	10562	1	385	10769	4	53	10926	1	48	11446	3	95
04015	1	275	10336	8	414	10563	8	385	10770	0	52	10927	8	48	11455	5	95
04017	5	275	10350	4	414	10564	5	385	10771	7	53	10928	5	48	11495	1	78, 80
04020	5	274	10351	1	414	10565	2	385	10775	5	53	10990	2	57, 419	11496	8	78
04021	2	274	10352	8	49	10566	9	385	10776	2	53	10991	9	57, 419	11497	5	78
04446	3	293	10353	5	49	10567	6	385	10777	9	19, 31, 32, 33, 42, 496	10992	6	57, 419	11498	2	78
06401	0	105, 492	10354	2	49	10568	3	385	10778	6	62	10993	3	58	11499	9	78
06501	7	491	10355	9	415	10569	0	385	10781	6	496	10994	0	58	11503	3	29
06503	1	105	10360	3	415	10570	6	385	10782	3	28, 112, 496	10995	7	57, 419	11505	7	29
06504	8	491	10361	0	415	10571	3	385	10788	5	41	10996	4	57, 419	11510	1	28
06506	2	491	10362	7	415	10572	0	385	10789	2	41	11000	7	100	11512	5	29
06510	9	105, 122, 134, 217, 288, 491	10400	6	37, 384	10573	7	385	10791	5	25, 26, 27, 28, 29, 30, 496	11008	3	17, 26, 29, 315, 487	11514	9	28
06512	3	75, 122, 129, 217, 491	10403	7	37, 384	10574	4	385	10792	2	51	11010	6	25, 26, 28, 29, 170, 183, 315, 487	11522	4	81
06515	4	491	10404	4	37, 384	10575	1	385	10795	3	41	11013	7	486	11523	1	80, 81
06517	8	491	10405	1	37, 384	10576	8	385	10796	0	41	11016	8	129, 487	11524	8	80
06519	2	129, 135, 180, 289, 290, 488	10409	9	37, 384	10577	5	385	10800	4	41	11018	2	17, 315, 487	11526	2	80
06520	8	75, 122, 129, 134, 135, 180, 288, 289	10410	5	37, 384	10578	2	385	10801	1	42	11020	5	100	11527	9	80
06521	5	129, 135, 180, 289, 290, 489	10411	2	37, 384	10579	9	385	10802	8	43	11021	2	170, 183, 485	11528	6	81
06525	3	180, 290, 489	10415	0	38	10585	0	385	10803	5	42	11022	9	324, 485	11529	3	81
06701	1	105, 492	10416	7	38	10586	7	385	10804	2	42	11026	7	316, 485	11533	0	30
08201	4	101	10417	4	38	10587	4	385	10807	3	42	11027	4	170, 316, 318, 324, 485	11538	5	30
09010	1	102	10418	1	38	10588	1	385	10808	0	42	11028	1	316, 485	11540	8	26
09013	2	102, 487	10422	8	39	10589	8	385	10809	7	42	11032	8	100	11541	5	26
09023	1	488	10424	2	39, 40	10608	6	42	10812	7	42	11038	0	100	11542	2	27
09080	4	106	10426	6	39, 40	10661	1	19, 31, 32, 496	10814	1	42	11040	3	100	11543	9	27
09082	8	30	10427	3	40	10663	5	45	10825	7	46	11041	0	100, 166, 170, 188, 484	11546	0	25
09083	5	30	10428	0	39, 40	10668	0	62	10830	1	45	11042	7	100, 166, 183, 188, 318, 324	11547	7	25
09090	3	35	10430	3	39	10690	1	52, 118	10833	2	45	11043	4	100, 166, 188, 484	11555	2	316
			10435	8	40	10691	8	52	10836	3	20, 44				11556	9	93
			10440	2	44	10700	7	41	10837	0	20, 44				11557	6	84
			10450	1	36, 383	10701	4	42	10838	7	20, 44				11558	3	84
			10451	8	36, 383	10703	8	42	10839	4	20, 44						
			10500	3	386	10704	5	42									
			10501	0	39, 40, 386	10707	6	42									
			10502	7	386												

11563	7	58	11780	8	141	11973	4	62	12396	0	337	15348	6	154	2		
11572	9	93	11781	5	141	11974	1	62	12397	7	335, 337	15350	9	490	23642	4	105
11573	6	93	11795	2	79	11975	8	60	12398	4	337	15351	6	490			
11574	3	58	11805	8	60	11977	2	364	12399	1	337	15400	1	156	3		
11575	0	58	11807	2	60	11978	9	360	12403	5	338	15401	8	156	30000	2	74
11576	7	58	11810	2	32	11979	6	364	12404	2	336	15402	5	156	30001	9	74
11595	8	77, 81	11811	9	31, 32	11980	2	79	12483	7	338	15403	2	156	30002	6	74
11596	5	77	11812	6	31	11981	9	79	12484	4	338	15404	9	156	30020	0	74
11597	2	77	11813	3	31	11986	4	79	12879	8	304, 495	15416	2	156	30021	7	74
11598	9	77	11815	7	32	11998	7	138, 295, 367	12940	5	14	15417	9	156	30045	3	467
11599	6	77	11816	4	31, 32	11999	4	138, 295, 367	12941	2	14	15418	6	156	30046	0	467
11607	8	93	11817	1	31	12000	6	100	12990	0	404	15419	3	156	30047	7	467
11616	0	24	11818	8	31	12008	2	487	13122	4	104	15420	9	156	30048	4	467
11617	7	24	11840	9	59	12010	5	487	13377	8	469	15421	6	156	30049	1	467
11619	1	112	11841	6	59	12065	5	100	13378	5	469	15424	7	156	30050	7	19
11620	7	22, 330	11845	4	33	12100	3	100	13379	2	469	15425	4	156	30052	1	19
11621	4	22, 330	11846	1	31, 32	12225	3	345	13380	8	111, 251	15449	0	156	30057	6	467
11622	1	23, 331	11847	8	32	12232	1	346	13382	2	104	15450	6	156	30058	3	468
11623	8	22, 330	11848	5	31, 32	12233	8	344	13385	3	104	15451	3	156	30059	0	467
11625	2	273	11849	2	32	12235	2	345	13622	9	104	15452	0	156	30061	3	467
11626	9	22, 330	11859	1	495	12236	9	344	13940	4	14	15453	7	156	30062	0	467
11627	6	22, 330	11865	2	78, 495	12243	7	348	13941	1	14	15454	4	156	30063	7	467
11628	3	23, 331	11866	9	495	12244	4	348	13955	8	15	15455	1	156	30065	1	369, 471
11629	0	22, 330	11868	3	31, 32, 78, 495	12245	1	344	13965	7	61	15456	8	156	30066	8	369, 471
11645	0	28, 112	11875	1	33, 77, 495	12249	9	343, 344	13966	4	71	15457	5	156	30067	5	369, 471
11647	4	141, 272	11878	2	31, 32, 33, 77, 495	12270	3	76, 341	13980	0	19	15458	2	156	30068	2	369, 471
11648	1	141, 272	11879	9	304, 495	12271	0	76, 341	13981	7	19	15460	5	156	30069	9	369, 471
11649	8	272	11881	2	474	12272	7	76, 341	13987	9	21, 61	15461	2	156	30070	5	369, 471
11650	4	273	11882	2	474	12285	7	349	13990	9	18	15462	9	156	30071	2	369, 471
11651	1	273	11884	3	65	12287	1	47, 348, 349	13995	4	21	15467	4	156	30075	0	369, 470
11671	9	47, 348	11885	0	65	12290	1	350	14940	3	14	15473	5	157	30076	7	369, 470
11672	6	47, 348	11887	4	92	12291	8	337, 338, 349	14941	0	14	15474	2	157	30077	4	369, 470
11675	7	344	11888	1	92	12292	5	350	14953	3	17	15475	9	157	30078	1	369, 470
11683	2	350	11889	8	92	12294	9	350	14954	0	17	15477	3	157	30108	5	293, 426
11705	1	52, 118	11891	1	92	12295	6	76, 334, 336, 337, 338, 340, 341, 349	14956	4	17	15485	8	157	30110	8	293, 426
11706	8	52, 118	11901	7	346				14965	6	61	15486	5	157	30111	5	109, 421
11711	2	70	11910	9	346				14966	3	71	15501	5	157	30112	2	109, 421
11712	9	70	11915	4	345	12296	3	336, 349	14970	0	16	15502	2	157	30113	9	109, 421
11713	6	70	11916	1	345	12299	4	349	14980	9	19	15503	9	91, 157	30114	6	110, 422
11714	3	70	11917	8	345	12300	7	343	14981	6	19	15504	6	157	30115	3	109, 421
11715	0	23, 331	11921	5	294	12310	6	348	14987	8	21, 61	15505	3	157	30116	0	109, 421
11716	7	23, 331	11922	2	294	12322	9	339	14990	8	18	15506	0	76, 91, 157, 341	30117	7	109, 421
11717	4	23, 331	11930	7	296	12323	6	339	14995	3	21	15513	8	98, 157	30118	4	110, 421
11718	1	23, 331	11931	4	296	12324	3	340	15100	0	154	15514	5	98, 157	30119	1	110, 421
11720	4	139	11940	6	368	12325	0	340	15101	7	154	15514	5	98, 157	30120	7	110, 210
11721	1	22, 330	11945	1	365	12329	8	342	15110	9	154	15620	3	75	30121	4	110, 210
11722	8	22, 330	11946	8	365	12330	4	342	15111	6	154	15621	0	75	30126	9	110, 422
11723	5	22, 330	11947	5	365	12335	9	342	15112	3	154	15622	7	75	30130	6	111, 251, 420
11724	2	22, 330	11948	2	137, 366	12336	6	342	15113	0	154	15623	4	75	30131	3	111, 251, 420
11726	6	246, 273	11949	9	137, 366	12337	3	342	15116	1	154	15921	1	270	30132	0	111, 251, 420
11727	3	128, 246, 273	11950	5	368	12338	0	342	15200	7	154	15925	9	270	30133	7	111, 251, 420
11730	3	139	11951	2	137, 366	12350	2	343	15201	4	154	15926	6	270	30134	4	111, 251
11740	2	68	11952	9	137, 366	12352	6	335	15215	1	154	17910	3	15	30140	5	109, 251, 420
11762	4	140	11954	3	138, 367	12353	3	335	15216	8	154	17922	6	15	30141	2	109, 251, 420
11763	1	140	11955	0	138, 367	12354	0	335	15217	5	154	18121	2	492	30142	9	109, 251, 420
11765	5	140	11960	4	138, 367	12360	1	345	15320	2	157, 328	18380	3	488	30148	1	109, 422
11767	9	139	11965	9	137, 366	12366	3	335, 338	15322	6	157, 328	18387	2	27, 315, 488	30149	8	109, 422
11768	6	139	11966	6	137, 312, 366	12370	0	335	15324	0	157, 328	18388	9	27, 29, 30, 217, 315, 488	30200	6	326
11770	9	140	11969	7	92	12371	7	335	15326	4	328	18389	6	16, 315	30206	8	327
11771	6	140	11970	3	60	12372	4	335	15331	8	328				30207	5	327
11775	4	58	11971	0	62	12372	4	335	15332	5	328				30208	2	327
11776	1	58	11972	7	62	12393	9	338	15334	9	328				30210	5	326
11778	5	140				12394	6	336	15335	6	328				30220	4	326

30230	3	326	30443	7	320	35730	3	292	36124	9	381	40223	2	312	40445	8	265
30240	2	326	30444	4	320	35734	1	292	36125	6	228, 379	40224	9	313	40446	5	265
30250	1	326	30445	1	320	35912	3	293	36126	3	379	40225	6	312	40450	2	261
30260	0	481	30446	8	320	36003	7	373	36127	0	228, 379	40226	3	313	40453	3	265
30263	1	481	30447	5	320	36004	4	373	36130	0	54, 382	40227	0	312	40454	0	265
30270	9	326	30450	5	320	36010	5	395	36233	8	292	40228	7	313	40455	7	262
30276	1	327	30451	2	320	36011	2	395	36323	6	292	40229	4	312	40457	1	262
30277	8	327	33206	5	71	36013	6	406	38202	2	101	40230	0	313	40458	8	262
30279	2	319	33207	2	71	36015	0	405				40240	9	313	40460	1	262
30280	8	319	33208	9	85	36017	4	406	4			40242	3	313	40461	8	262, 263
30281	5	319	33209	6	85	36020	4	373	40007	8	294, 317	40243	0	312	40462	5	262, 263
30282	2	319	33210	2	84	36021	1	373	40009	2	294, 317	40244	7	313	40463	2	262
30283	9	319	33211	9	86	36025	9	372	40010	8	294, 317	40245	4	312	40464	9	262
30285	3	319	33212	6	86	36026	6	372	40011	5	294, 317	40246	1	313	40470	0	263
30286	0	319	33214	0	86	36028	0	372	40012	2	294, 317	40247	8	312	40472	4	263
30299	0	311	33215	7	86	36030	3	379	40013	9	294, 317	40249	2	312	40474	8	263
30310	2	326	33216	4	86	36032	7	380	40110	5	102	40260	7	313	40476	2	263
30325	6	87	33217	1	86	36033	4	405	40115	0	102	40262	1	313	40478	6	263
30331	7	23, 331	33219	5	86	36034	1	380	40130	3	294, 317	40263	8	313	40480	9	263
30332	4	374	33220	1	86	36037	2	405	40131	0	294, 317	40264	5	313	40482	3	264
30333	1	382	33232	4	93	36038	9	379	40132	7	314	40270	6	313	40485	4	265
30334	8	82	33238	6	87	36044	0	376	40135	8	314	40272	0	313	40486	1	268, 418
30335	5	85	33246	1	79, 286	36045	7	376	40137	2	314	40274	4	313	40487	8	268, 418
30336	2	83	33248	5	87	36046	4	376	40139	6	314	40276	8	313	40488	5	269, 416
30337	9	83, 324	33249	2	96	36047	1	376	40140	2	314	40290	4	16, 312	40490	8	268, 418
30338	6	83	33250	8	96	36048	8	378	40144	0	93, 314	40291	1	16, 312	40494	6	268, 418
30339	3	82	33251	5	96	36052	5	378	40148	8	314	40292	8	16, 312	40498	4	418
30340	9	321	33252	2	96, 184	36053	2	378	40149	5	315	40293	5	16, 312	40499	1	418
30341	6	321	33255	3	74, 98	36054	9	378	40150	1	315	40294	2	16, 315	40500	4	257
30345	4	321	33256	0	74, 98	36055	6	373	40152	5	314	40295	9	16, 315	40501	1	257
30346	1	321	33260	7	96	36056	3	378	40153	2	315	40296	6	311	40503	5	257
30347	8	321	33261	4	96	36057	0	377	40159	4	314	40297	3	311	40504	2	126, 257
30348	5	321	33262	1	96	36062	4	380	40179	2	317	40299	7	311	40505	9	257
30350	8	321	33269	0	69, 96	36063	1	380	40182	2	317	40300	0	265	40506	6	268, 417
30351	5	321	33270	6	69, 96	36066	2	373	40185	3	236	40310	9	261	40507	3	257
30355	3	320	33271	3	69, 96	36068	6	374	40186	0	106, 233	40311	6	261	40508	0	267, 417
30356	0	126, 320	33272	0	96	36069	3	374	40187	7	106, 233	40312	3	261	40509	7	267, 417
30357	7	322, 434	33273	7	96	36074	7	379	40188	4	106, 233	40313	0	261	40510	3	268, 418
30358	4	322, 434	33280	5	98	36075	4	382	40189	1	327	40320	8	261	40511	0	266
30360	7	321	33281	2	98	36077	8	376	40189	1	327	40330	7	264	40516	5	240, 393
30361	4	321	33282	9	97, 184, 216, 287	36087	7	377	40190	7	327	40331	4	264	40517	2	240, 393
30370	6	321	33288	1	94	36090	7	381	40192	1	314	40333	8	264	40535	6	253
30371	3	321	33292	8	135, 289	36095	2	55, 377	40193	8	314	40404	5	272	40536	3	253
30380	5	322	33293	5	135, 289	36096	9	55, 377	40194	5	314	40405	2	272	40537	0	253
30385	0	322	33294	2	135, 136, 289, 290, 489	36099	0	381	40195	2	314	40410	6	260	40538	7	254
30390	4	322	33295	9	135, 136, 289, 290, 489	36100	3	55, 77	40196	9	314	40411	3	260	40539	4	254
30395	9	322				36101	0	55, 377	40198	3	316	40412	0	260	40540	0	254
30396	6	322				36102	7	404	40200	3	291	40413	7	260	40541	7	255
30410	9	324				36103	4	404	40201	0	291	40414	4	266	40544	8	257
30411	6	324				36104	1	381	40202	7	291	40415	1	261	40545	5	257, 265
30412	3	324	33296	6	135, 289	36105	8	381	40203	4	291	40416	8	256	40546	2	253
30413	0	324	33297	3	135, 289	36106	5	55, 375	40204	1	291	40417	5	256	40547	9	253
30414	7	324	33300	0	66	36107	2	55, 375	40205	8	291	40418	2	256	40548	6	253
30415	4	324	33301	7	67	36108	9	55, 375	40206	5	291	40424	3	264	40549	3	255
30416	1	324	33302	4	66	36109	6	55, 375	40207	2	292	40425	0	303	40550	9	255
30420	8	325	33303	1	67	36111	9	55, 375	40208	9	291	40435	9	259	40551	6	256
30421	5	325	33304	8	66, 67, 97	36112	6	55, 375	40210	2	318	40436	6	259	40552	3	256
30422	2	325	33305	5	97, 118	36115	7	372	40211	9	318	40437	3	259	40553	0	255
30423	9	325	35065	6	350	36116	4	374	40212	6	318	40438	0	259	40554	7	255
30424	6	325	35343	5	350	36120	1	375	40214	0	318	40439	7	259	40555	4	126, 253, 266
30440	6	320	35711	2	293	36121	8	375	40216	4	318	40440	3	261	40556	1	126, 253, 266
30441	3	320	35716	7	52, 118, 293	36122	5	381	40220	1	313	40441	0	261	40557	8	254
30442	0	320	35720	4	292	36123	2	381	40222	5	313	40442	7	259	40558	5	254

40570	7	252	40666	7	279	40768	8	239	60042	3	276	71001	6	451,474	74708	1	465
40571	4	252	40667	4	270,279				60044	7	278	71002	3	451,474	74721	0	463
40572	1	252	40668	1	270,279	5			60045	4	278	71003	0	451,474	74722	7	463
40573	8	252	40669	8	279	50002	0	84	60046	1	278	71004	7	451,474	74731	9	466
40574	5	252	40670	4	111,114, 126,236, 251,420	50205	5	309	60270	0	102	71005	4	451,474	74750	0	418
40575	2	252				50210	9	309	60310	3	102	71006	1	451,474	75001	2	271
40576	9	252	40676	6	138,230,367	50305	2	309	60502	2	277	71400	7	426	75002	9	271
40577	6	252	40680	3	230	50400	4	309	60503	9	277	71421	2	477,496	75600	7	451
40600	1	234	40681	0	230	50600	8	310	60505	3	277	71430	4	418	75800	1	450
40601	8	114,234	40685	8	128,236,245	50601	5	310	60508	4	277	71431	1	403,472	75801	8	449
40602	5	234	40686	5	128,236,246	50602	2	310	60509	1	276	71433	5	426	75803	2	451
40603	2	234	40690	2	237,323	50603	9	310	60510	7	276	71440	3	364	75804	9	451
40604	9	237,323	40691	9	237,323	50605	3	310	60511	4	276	71441	0	365	75805	6	407
40605	6	235	40692	6	237,323	50606	0	310	60512	1	276	71460	1	299	75806	3	450
40606	3	235	40693	3	237,323	50607	7	310	60520	6	277	71461	8	299	75807	0	450
40607	0	235	40694	0	237,323	50608	4	310	60521	3	277	71470	0	304	75808	7	452
40610	0	234	40695	7	237,323	50612	1	310	60522	0	277	71471	7	304	75809	4	452
40611	7	234	40700	8	229	50620	6	311	60523	7	277	71480	9	304	75810	0	449
40612	4	234	40701	5	229	50621	3	311	60524	4	277	71487	8	302	75820	9	407,452
40613	1	234	40702	2	229	50622	0	311	60525	1	277	71489	2	302	75821	6	407,452
40616	2	235	40703	9	229	50623	7	311	60526	8	277	71490	8	304	75822	3	449
40617	9	235	40704	6	229	50624	4	311	60527	5	277	71491	5	304	75823	0	449
40618	6	235	40705	3	229	50625	1	311	60528	2	277	71492	2	301	75824	7	449
40620	9	234	40706	0	229	50626	8	311	60530	5	276	71493	9	301	75825	4	448
40621	6	234	40707	7	229	50627	5	311	60531	2	276	71494	6	301	75830	8	448
40622	3	234	40708	4	229	50630	5	310	60534	3	276	71495	3	303	75831	5	448
40623	0	234	40709	1	229	50631	2	310	60535	0	278	71496	0	298	75832	2	448
40624	7	234	40710	7	229,235	50644	2	318	60536	7	278	71497	7	298	75840	7	446
40625	4	114,234	40711	4	229,235	50702	9	309	60537	4	278	71498	4	302	75841	4	446
40626	1	234	40712	1	228	50707	4	309	60540	4	276	71499	1	302	75842	1	446
40627	8	234	40713	8	228	50710	4	308	60541	1	276	71510	3	299	75843	8	446
40628	5	234	40720	6	238	50712	8	308	60542	8	276	71512	7	299	75844	5	446
40629	2	234	40721	3	238	50722	7	309	60543	5	278	71513	4	299	75850	6	448
40630	8	235	40722	0	229,238	50800	2	310	60544	2	278	71516	5	299	75851	3	448
40631	5	235	40723	7	229,238	50801	9	310	60545	9	278	71520	2	298	75852	0	448
40632	2	280	40724	4	238	50802	6	310	60546	6	278	71521	9	297	75853	7	407,448
40633	9	280	40725	1	238	50803	3	310	60551	0	277	71522	6	297	75854	4	407,448
40634	6	280	40726	8	229,238	50805	7	310	60552	7	277	71523	3	297	75855	1	407,448
40635	3	280	40727	5	229,238	50806	4	310	60554	1	277	71527	1	297	75900	8	441
40636	0	280	40728	2	238	50807	1	310	61190	0	102	71528	8	297	75902	2	441
40637	7	280	40729	9	238	50808	8	310	61280	8	102	71529	5	297	75903	9	441
40638	4	280	40730	5	232	50815	6	310	61400	0	102	71531	8	298	75904	6	441
40640	7	235,269,415	40731	2	232	50817	0	310	65060	2	271,347	73502	6	478	75906	0	441,481
40642	1	233	40732	9	232	50823	1	310	65061	9	347	73505	7	478	75907	7	441
40643	8	233	40733	6	232	50905	4	308	65062	6	347	73506	4	478	75908	4	441
40644	5	233	40734	3	232	50908	5	308	65070	1	394	73507	1	478,479	75912	1	441
40645	2	280	40735	0	232	50910	8	308	65071	8	394	73508	8	478	77315	8	474
40646	9	280	40736	7	232	50913	9	308	65072	5	394	73509	5	478	77338	7	466
40647	6	280	40737	4	232	50915	3	308	66900	0	329,435	73510	1	478	77350	9	472,481
40654	4	236	40738	1	232	50918	4	308	66901	7	329,435	73511	8	478	79000	1	72
40655	1	111,236, 251,420	40740	4	233	6			66902	4	329,435	73513	2	478	79001	8	72
40656	8	111,236, 251,420	40741	1	233	60002	7	277	66904	8	472	73515	6	479	79002	5	72
40657	5	236	40742	8	233	60012	6	277	66905	5	433	73750	1	481	79003	2	72
40658	2	236	40752	7	491	60014	0	277	66906	2	433	74201	7	462	79004	9	72
40659	9	236	40760	2	239	60015	7	277	66910	9	305,432,497	74402	8	465	79005	6	72
40660	5	233	40761	9	239	60016	4	277	66911	6	305,432,497	74404	2	465	79006	3	72
40661	2	279	40762	6	239	60018	8	277	66912	3	305,432,497	74700	5	463	79007	0	72
40662	9	279	40763	3	239	60019	5	277	66913	0	305,432,497	74701	2	463	79553	2	84
40663	6	279	40764	0	239	60037	9	276	66914	7	305,432,497	74702	9	463			
40664	3	279	40765	7	239	60038	6	276	66915	4	305,432,497	74703	6	463			
40665	0	279	40766	4	239	60040	9	276	66916	1	305,432,497	74705	0	463	8		
			40767	1	239	60041	6	277	66917	8	305,432,497	74706	7	463	80023	6	356
									7			74707	4	464	80024	3	356

80025	0	356	81791	3	355	82072	2	359	82276	4	361	83433	0	207, 363	83718	8	197
80026	7	356	81795	1	355	82073	9	359	82277	1	361	83434	7	207, 363	83720	1	197
80027	4	356	81796	8	360	82074	6	359	82278	8	361	83437	8	214	83721	8	196
80028	1	356	81800	2	353	82076	0	359	82279	5	361	83438	5	214	83722	5	197
80029	8	356	81801	9	353	82077	7	359	82280	1	361	83440	8	214	83723	2	196
81000	6	353	81802	6	353	82078	4	359	82281	8	361	83441	5	214	83724	9	197
81095	2	353	81804	0	353	82081	4	359	82300	6	361	83443	9	214	83725	6	196
81100	3	353	81806	4	353	82100	2	361	82301	3	361	83450	7	208	83726	3	197
81101	0	353	81850	7	354	82101	9	357	82306	8	361	83451	4	208, 225	83727	0	196
81102	7	353	81891	0	355	82104	0	357	82307	5	281	83452	1	208	83728	7	197
81104	1	353	81895	8	355	82106	4	357	82308	2	281	83453	8	208	83730	0	197
81106	5	353	81901	6	354	82108	8	357	82309	9	281	83454	5	208	83732	4	197
81108	9	353	81902	3	354	82110	1	357	82310	5	79, 284, 286	83455	2	208	83735	5	196
81109	6	353	81903	0	354	82112	5	357	82312	9	79, 128, 245, 284, 286	83466	8	208, 210	83739	3	196
81116	4	351	81904	7	354	82113	2	357	82314	3	79, 284, 286	83467	5	208	83740	9	198
81117	1	356	81905	4	354	82114	9	357	82316	7	246, 285	83468	2	208	83742	3	198
81118	8	356	81906	1	354	82116	3	357	82318	1	286	83469	9	208	83744	7	198
81191	1	355	81907	8	354	82117	0	357	82319	8	286	83479	8	207, 363	83748	5	225, 362
81195	9	355	81908	5	354	82118	7	357	82328	0	61, 64	83480	4	207, 363	83749	2	225, 362
81198	0	360	81909	2	354	82119	4	357	82328	0	61, 64	83481	1	68, 207, 363	83750	8	225, 362
81199	7	360	81910	8	354	82120	0	357	82338	9	286	83482	8	207, 363	83751	5	362
81200	0	353	81911	5	354	82122	4	357	82345	7	284	83484	2	208	83752	2	225, 362
81201	7	353	81996	2	356	82123	1	357	82346	4	284	83486	6	220	83753	9	225, 362
81202	4	353	81997	9	356	82128	6	357	82347	1	284	83487	3	220	83754	6	225, 362
81204	8	353	81998	6	356	82129	3	357	82350	1	125, 248, 285	83488	0	429	83755	3	225, 362
81206	2	353	81999	3	356	82130	9	357	82351	8	125, 248, 285	83489	7	429	83756	0	225, 362
81208	6	353	82001	2	225, 358, 362	82132	3	357	82352	5	284	83490	3	207, 363	83757	7	225, 362
81209	3	353	82003	6	358	82134	7	357	82354	9	285	83491	0	68, 207, 363	83758	4	225, 362
81292	5	355	82004	3	358	82136	1	357	82355	6	15, 360	83492	7	207, 363	83759	1	225, 362
81295	6	355	82005	0	358	82137	8	357	82356	3	15, 360	83498	9	210	83760	7	224, 363
81296	3	360	82006	7	358	82138	5	357	82357	0	15, 360	83499	6	210	83761	4	224, 363
81300	7	353	82007	4	358	82140	8	357	82359	4	285	83500	9	208	83762	1	224, 363
81302	1	353	82008	1	358	82142	2	357	82360	0	282	83514	6	208	83763	8	224, 363
81304	5	353	82010	4	358	82150	7	357	82361	7	282	83592	4	207, 363	83764	5	224, 363
81306	9	353	82012	8	358	82151	4	357	82362	4	283	83597	9	207, 363	83765	2	224, 363
81308	3	353	82013	5	225, 358, 362	82159	0	357	82363	1	283	83600	6	186, 210, 494	83766	9	224, 363
81391	5	355	82014	2	358	82200	9	361	82370	9	285	83601	3	183, 186, 210, 494	83768	3	224, 363
81395	3	355	82016	6	358	82210	8	338, 340	82371	6	285	83603	7	209, 494	83769	0	224, 363
81400	4	353	82017	3	358	82215	3	338, 340	82394	5	286	83604	4	209, 494	83772	0	224, 363
81401	1	353	82018	0	358	82239	9	65, 282, 283	82395	2	286	83605	1	213, 494	83773	7	224, 363
81402	8	353	82019	7	225, 358, 362	82240	5	65, 282, 283	82419	5	368, 477	83606	8	213, 494	83777	5	213, 239
81404	2	353	82020	3	358	82241	2	282	82420	1	368	83606	8	213, 494	83780	5	213, 239
81406	6	353	82022	7	358	82242	9	282	82440	9	368, 480	83607	5	213, 494	83781	2	213, 237, 239, 323
81408	0	353	82023	4	358	82243	6	65	82441	6	368, 480	83610	5	429	83782	9	213, 239
81492	9	355	82028	9	358	82244	3	65	83310	4	73	83611	2	429	83783	6	213, 239
81495	0	355	82029	6	225, 358, 362	82245	0	283	83311	1	73	83612	9	429	83785	0	203
81502	5	353	82030	2	358	82246	7	283	83401	9	207, 363	83613	6	429	83787	4	203
81504	9	353	82032	6	358	82250	4	64	83402	6	207	83615	0	88	83788	1	203
81506	3	353	82034	0	358	82251	1	64	83403	3	207	83616	7	430	83789	8	203
81591	9	355	82036	4	358	82252	8	64	83404	0	207	83648	8	220	83790	4	203
81595	7	355	82037	1	225, 358, 362	82253	5	64	83405	7	207	83649	5	220	83790	4	203
81602	2	353	82038	8	358	82255	9	63	83406	4	207	83696	9	33, 212	83798	0	213, 239
81604	6	353	82040	1	358	82256	6	63	83407	1	207	83697	6	33, 212	83799	7	203
81606	0	353	82042	5	358	82257	3	63	83408	8	208	83698	3	33, 212	83800	0	202, 221
81608	4	353	82050	0	358	82265	8	63	83409	5	208	83699	0	33, 212	83801	7	218, 351
81692	3	355	82051	7	358	82266	5	63	83410	1	208	83700	3	19, 33, 212	83803	1	218, 351
81695	4	355	82059	3	358	82267	2	63	83414	9	208, 210	83701	0	19, 33, 212	83808	6	202, 221
81700	5	353	82064	7	359	82270	2	361	83415	6	208	83702	7	19, 33, 212	83828	4	202, 204
81701	2	353	82065	4	359	82271	9	361	83417	0	207	83703	4	19, 33, 212	83830	7	202, 204
81702	9	353	82066	1	359	82272	6	361	83418	7	207	83704	1	33, 212	83842	0	220
81704	3	353	82068	5	359	82273	3	361	83419	4	208	83705	8	33, 212	83843	7	220
81706	7	353	82069	2	359	82274	0	361	83424	8	220	83712	6	195	83848	2	218
81707	4	353	82070	8	359	82275	7	361	83426	2	220	83716	4	196	83851	2	218

83867	3	73	83992	2	186	84208	3	173	84445	2	222	84586	2	182	84824	5	169
83868	0	73	83994	6	186	84209	0	173	84446	9	222	84587	9	182	84825	2	168
83869	7	208, 217	84018	8	223, 239	84215	1	213	84448	3	222	84589	3	182	84826	9	168
83878	9	204	84020	1	218	84216	8	213	84449	0	222	84590	9	182	84827	6	168
83879	6	204	84021	8	218	84217	5	201, 223	84450	6	222	84592	3	183	84828	3	168
83880	2	212	84035	5	218	84220	5	213	84452	0	222	84593	0	183	84829	0	168
83881	9	212	84040	9	217	84221	2	212	84454	4	222	84605	0	181	84830	6	169
83884	0	208	84041	6	217	84230	4	199	84456	8	222	84606	7	181	84831	3	169
83887	1	219	84042	3	217	84231	1	199	84458	2	222	84607	4	181	84835	1	169
83888	8	219	84043	0	217	84232	8	199	84460	5	220	84608	1	181	84836	8	169
83889	5	219	84045	4	131, 423	84233	5	199	84462	9	203	84609	8	181	84837	5	169
83890	1	135, 216, 288	84046	1	15, 210	84244	1	186, 209	84464	3	203	84610	4	181	84860	3	73
83891	8	135, 216, 288	84047	8	15, 210	84245	8	186, 209	84466	7	203	84611	1	181	84861	0	73
83892	5	135, 216, 288	84048	5	15, 210	84251	9	110, 422	84470	4	221, 239	84612	8	181	84862	7	73
83893	2	216, 288	84100	0	190	84253	3	110, 422	84471	1	221, 239	84613	5	181	84863	4	73
83897	0	218, 351	84101	7	190	84256	4	171	84472	8	221, 239	84614	2	181	84875	7	189
83900	7	205	84103	1	192	84257	1	187	84490	2	211	84671	5	159	84876	4	189
83901	4	205	84104	8	192	84258	8	187	84491	9	211	84672	2	159	84900	6	193
83902	1	205	84105	5	192	84259	5	187	84492	6	211	84673	9	159	84901	3	193
83903	8	205	84106	2	192	84265	6	173	84509	1	164	84674	6	160	84902	0	193
83904	5	205	84107	9	191	84266	3	171	84510	7	164	84675	3	160	84903	7	193
83905	2	205	84108	6	191	84268	7	171	84511	4	164	84676	0	160	84904	4	194
83906	9	205	84109	3	191	84269	4	171	84512	1	164	84677	7	160	84905	1	194
83907	6	205	84110	9	191	84295	3	213	84514	5	164	84678	4	160	84906	8	194
83908	3	205	84111	6	191	84300	4	225, 362	84515	2	164	84680	7	161	84907	5	194
83909	0	205	84112	3	191	84301	1	225, 362	84517	6	164	84681	4	161	84908	2	194
83910	6	206	84113	0	191	84302	8	225, 362	84519	0	166	84682	1	161	84909	9	194
83911	3	206	84115	4	191	84303	5	225, 362	84520	6	166	84683	8	161	84910	5	194
83912	0	204, 206	84116	1	191	84304	2	225, 362	84521	3	166	84684	5	162	84911	2	194
83913	7	204, 206	84117	8	192	84305	9	225, 362	84522	0	166	84685	2	162	84912	9	194
83914	4	206	84118	5	192	84306	6	225, 362	84523	7	165	84686	9	162	84920	4	179
83915	1	206	84119	2	192	84307	3	225, 362	84524	4	165	84687	6	162	84921	1	179
83916	8	206	84125	3	200	84308	0	225, 362	84525	1	165	84688	3	162	84922	8	179
83917	5	206	84126	0	200	84309	7	225, 362	84526	8	165	84689	0	162	84923	5	179
83918	2	206	84128	4	200, 219	84310	3	225, 362	84528	2	165	84690	6	162	84924	2	179
83919	9	206	84130	7	201	84311	0	225, 362	84529	9	165	84728	6	192	84925	9	179
83920	5	33, 69, 206, 212, 214, 494	84131	4	201	84329	5	167	84530	5	165	84729	3	192	84926	6	180
83921	2	206, 494	84132	1	201	84331	8	167	84555	8	182	84730	9	192	84927	3	180
83922	9	206, 494	84133	8	201	84335	6	167	84556	5	182	84731	6	190	84928	0	180
83923	6	206	84134	5	201	84337	0	167	84558	9	182	84732	3	190	84929	7	180
83924	3	206	84135	2	201	84348	6	196	84559	6	182	84733	0	190	84930	3	181
83925	0	206	84158	1	200, 219	84349	3	196	84561	9	182	84750	7	221	84931	0	181
83926	7	206	84161	1	189	84351	6	196	84562	6	182	84775	0	223	84932	7	181
83929	8	195	84170	3	189	84353	0	196	84564	0	182	84776	7	223	84933	4	181
83932	8	197	84171	0	189	84355	4	195	84565	7	182	84777	4	223	84934	1	181
83933	5	197	84172	7	189	84365	3	174	84567	1	175	84778	1	223	84935	8	181
83935	9	197	84174	1	191	84366	0	174	84568	8	175	84779	8	223	84936	5	182
83941	0	198	84177	2	172	84377	6	174	84569	5	176	84780	4	223	84937	2	182
83946	5	198	84178	9	172	84378	3	174	84570	1	176	84781	1	223	84943	3	179
83947	2	198	84179	6	172	84379	0	174	84571	8	176	84782	8	223	84944	0	179
83949	6	198	84180	2	188	84380	6	174	84572	5	176	84783	5	223	84948	8	183
83955	7	185	84181	9	188	84381	3	174	84573	2	176	84785	9	203	84950	1	211
83956	4	185	84182	6	188	84400	1	169	84574	9	176	84803	0	163	84951	8	211
83957	1	185	84185	7	24, 188	84401	8	169	84575	6	175	84804	7	163	84958	7	211
83958	8	185	84186	4	24, 188	84402	5	169	84576	3	175	84805	4	163	84959	4	211
83960	1	202	84187	1	68, 188	84403	2	169	84577	0	176	84806	1	163	84962	4	181, 493
83961	8	202	84188	8	24, 188	84404	9	169	84578	7	176	84807	8	163	84963	1	181, 493
83962	5	202	84189	5	24, 188	84424	7	208	84579	4	176	84808	5	163	84964	8	181, 493
83971	7	185	84200	7	203	84425	4	208	84580	0	176	84815	3	163	84965	5	182, 493
83980	9	185	84202	1	203	84426	1	208	84581	7	176	84816	0	163	84966	2	182, 493
83981	6	186	84205	2	173	84427	8	208	84582	4	176	84819	1	163	84967	9	182, 493
			84206	9	173	84434	6	172	84583	1	182	84820	7	168	84968	6	182, 493
			84207	6	173	84444	5	222	84584	8	182	84821	4	168	84985	3	183

84986	0	170	85125	2	153	88636	0	453	93111	4	412	93255	5	476	93358	3	402
84987	7	183	85127	6	153	88637	7	445	93112	1	398	93256	2	476	93360	6	402
84988	4	170	85128	3	153	88639	1	463	93114	5	412	93257	9	476	93361	3	402
85021	7	148	85129	0	153	88640	7	444	93116	9	398	93258	6	476	93362	0	402
85024	8	148	85131	3	153	88642	1	444	93120	6	398	93259	3	475	93364	4	391
85025	5	148	85132	0	153	88643	8	450	93121	3	398	93260	9	475	93365	1	391
85026	2	148	85133	7	153	88644	5	450	93122	0	413	93261	6	475	93366	8	395
85027	9	148	85135	1	153	88645	2	450	93124	4	413	93270	8	476	93367	5	388
85028	6	148	85140	5	215	88688	9	466	93125	1	413	93271	5	476	93368	2	399
85029	3	149	85141	2	215	88717	6	464	93129	9	399	93272	2	476	93369	9	399
85030	9	149	85145	0	170	88810	4	456	93134	3	399	93273	9	476	93371	2	391
85036	1	149	85146	7	170	88811	1	456	93138	1	396	93274	6	476	93372	9	391
85037	8	149	85150	4	201	88823	4	456	93139	8	396	93275	3	476	93373	6	391
85038	5	149	85151	1	201	88826	5	456	93140	4	396	93280	7	477	93374	3	391
85040	8	217	85200	6	147	88827	2	456	93141	1	411	93281	4	477	93375	0	392
85041	5	217	85201	3	147	88829	6	457	93144	2	411	93300	2	400	93380	4	408
85042	2	217	85202	0	147	88834	0	457	93145	9	411	93301	9	413	93381	1	408
85043	9	217	85203	7	147	88836	4	457	93146	6	411	93302	6	413	93382	8	408
85055	2	149	85204	4	147	88839	5	458	93147	3	411	93303	3	409	93383	5	408
85056	9	149	85205	1	147	88840	1	458	93148	0	411	93304	0	409	93384	2	408
85057	6	149	85206	8	147	88843	2	401, 458	93152	7	399	93306	4	401	93385	9	408
85060	6	145	85207	5	147	88846	3	401, 457	93153	4	399	93307	1	401	93386	6	408
85061	3	145	85208	2	147	88850	0	457	93154	1	476	93308	8	266, 411	93390	3	408
85062	0	145	85211	2	184	88853	1	458	93155	8	475	93309	5	266, 411	93391	0	408
85063	7	144	85230	3	184, 216, 287	88855	5	473	93156	5	475	93310	1	389	93392	7	408
85064	4	144	85231	0	184, 216, 287	88900	2	473	93157	2	475	93311	8	389	93393	4	408
85065	1	144	85240	2	221, 239	88901	9	473	93160	2	412	93312	5	400	93394	1	408
85066	8	144	85241	9	221, 239	88902	6	473	93161	9	410	93313	2	400	93395	8	408
85067	5	144	85242	6	221, 239	88903	3	474	93163	3	476	93318	7	401, 464	93398	9	392
85068	2	144	85243	3	221, 239	88911	8	473	93164	0	397	93321	7	138, 367	93399	6	392
85069	9	145	85244	0	221, 239	88912	5	473	93165	7	397	93322	4	389	93400	9	392
85070	5	145	85250	1	214	88920	0	459	93166	4	409	93323	1	389	98120	1	90
85071	2	145	85251	8	214	88921	7	459	93167	1	409	93324	8	397			
85072	9	145	85252	5	214	88922	4	459	93168	8	409	93325	5	396			
85073	6	144	85260	0	209	88923	1	459	93169	5	409	93326	2	395			
85074	3	146	85261	7	209	88928	6	459	93170	1	410	93327	9	393			
85075	0	146	85266	2	209	88929	3	461	93171	8	401	93328	6	393			
85076	7	146	85267	9	209	88930	9	461, 480	93173	2	409	93329	3	393			
85077	4	146	88080	1	479	88932	3	459	93174	9	409	93330	9	372, 388			
85080	4	150, 246	88081	8	479	88933	0	459	93175	6	409	93331	6	390			
85081	1	150, 246	88090	0	478	88935	4	460	93176	3	401	93332	3	390			
85082	8	151	88099	3	462	88937	8	460	93179	4	396	93333	0	390			
85083	5	151	88220	1	231	88938	5	460	93180	0	402	93334	7	392			
85084	2	151	88221	8	231	88939	2	460	93181	7	402	93335	4	392			
85088	0	187	88222	5	231	88940	8	460	93182	4	402	93336	1	393			
85092	7	146	88223	2	231	88941	5	460	93189	3	403, 472	93337	8	393			
85093	4	146	88224	9	231	88942	2	460	93190	9	407	93338	5	393			
85097	2	146	88225	6	231	88946	0	461	93191	6	406	93342	2	390			
85098	9	144	88226	3	231	88947	7	461	93192	3	406	93343	9	390			
85099	6	83, 186	88227	0	231	88948	4	461	93200	5	405	93344	6	390			
85100	9	152	88228	7	231	88949	1	462, 480	93201	2	396	93345	3	389			
85101	6	152	88229	4	231				93211	1	395	93346	0	388			
85103	0	152	88256	0	480	9			93212	8	395	93347	7	400			
85104	7	152	88271	3	477	90902	1	34	93214	2	403, 472	93348	4	400			
85105	4	152	88285	0	360	93034	6	399	93220	3	405	93349	1	400			
85107	8	152	88287	4	473	93090	2	54, 380	93225	8	475	93350	7	396			
85108	5	152	88288	1	473	93091	9	54, 380	93226	5	475	93351	4	397			
85109	2	152	88598	1	453	93092	6	54, 380	93230	2	54	93352	1	397			
85111	5	152	88608	7	445	93093	3	54, 380	93250	0	476	93353	8	397			
85120	7	153	88609	4	453	93101	5	411	93251	7	476	93354	5	397			
85121	4	153	88618	6	463	93102	2	412	93252	4	476	93355	2	397			
85123	8	153	88627	8	453	93105	3	54, 380	93253	1	476	93356	9	398			
85124	5	153	88628	5	453	93110	7	412	93254	8	476	93357	6	398			

DE Impressum

Herausgeber: Assheuer + Pott GmbH & Co. KG, Talweg 11, 59846 Sundern, Tel. +49 2933 97350, info@aps-germany.de, www.aps-germany.de
Gestaltung: Assheuer + Pott GmbH & Co. KG · Druck: Druck- und Verlagshaus Fromm + Rasch GmbH & Co. KG, Breiter Gang 10-16, 49074 Osnabrück
Wir behalten uns das Recht vor, die angegebenen Spezifikationen jederzeit zu ändern. Irrtum, Druckfehler und technische Änderungen vorbehalten. Artikelbeschreibungen sowie Abbildungen und Fotodarstellungen sind ohne Gewähr. Alle Angebote ohne Dekoration. Alle Preise verstehen sich unverbindlich (UVP) in Euro zuzüglich der gesetzlichen Mehrwertsteuer.
© 2023 - Die Vervielfältigung dieses Kataloges - auch wenn partial - muss ausschließlich von der Assheuer + Pott GmbH & Co. KG genehmigt werden.
Bildnachweis: Niklas Thiemann Fotodesign · Stoll GmbH – Studio für Fotografie · track by track GmbH · iStock · Envato Elements Pty Ltd.

GB Imprint

Editor: Assheuer + Pott GmbH & Co. KG, Talweg 11, 59846 Sundern, Germany, Tel. +49 2933 97350, info@aps-germany.de, www.aps-germany.de
Design: Assheuer + Pott GmbH & Co. KG - Print: Druck- und Verlagshaus Fromm + Rasch GmbH & Co. KG, Breiter Gang 10-16, 49074 Osnabrück, Germany
We reserve the right to alter at any time the specifications stated without notice. Errors, printing error and technical changes reserved. Item description as well as images and illustrations are without guaranty. All offers are without decoration. All prices are without commitment (RRP) in Euro and exclude the legal VAT prescribed by law.
© 2023 - This catalogue may not be reproduced in whole or in part unless specific prior written authorization of Assheuer + Pott GmbH & Co. KG.
Picture credits: Niklas Thiemann Fotodesign · Stoll GmbH – Studio für Fotografie · track by track GmbH · iStock · Envato Elements Pty Ltd.

ES Impressum

Editor: Assheuer + Pott GmbH & Co. KG, Talweg 11, 59846 Sundern, Alemania, Tel. +49 2933 97350, info@aps-germany.de, www.aps-germany.de
Diseño gráfico: Assheuer + Pott GmbH & Co. KG - Impresión: Druck- und Verlagshaus Fromm + Rasch GmbH & Co. KG, Breiter Gang 10-16, 49074 Osnabrück, Alemania
Nos reservamos el derecho de efectuar modificaciones en cualquier momento, sin aviso previo. Salvo errores de imprenta o impresión o cambios técnicos. La descripción de los artículos, sus imágenes e ilustraciones son sin garantía. Los artículos se ofrecen sin decoración. Todos los precios indicados son precios sugeridos (PVR) en euros y a dichos precios se deberá añadir el impuesto sobre el valor añadido legal vigente.
© 2023 - Todas las reproducciones, aunque parciales, de este catálogo tienen que ser autorizadas por escrito por Assheuer + Pott GmbH & Co. KG.
Derechos de la imagen: Niklas Thiemann Fotodesign · Stoll GmbH – Studio für Fotografie · track by track GmbH · iStock · Envato Elements Pty Ltd.

FR Impressum

Éditeur: Assheuer + Pott GmbH & Co. KG, Talweg 11, 59846 Sundern, Allemagne, Tel. +49 2933 97350, info@aps-germany.de, www.aps-germany.de
Design: Assheuer + Pott GmbH & Co. KG - Impression: Druck- und Verlagshaus Fromm + Rasch GmbH & Co. KG, Breiter Gang 10-16, 49074 Osnabrück, Allemagne
Nous nous réservons le droit de modifier à tout moment les spécifications. Toutes erreurs, fautes d'impression et modifications techniques sont réservées. Les descriptions d'articles, les illustrations et les photos sont sans garantie. Toutes les articles s'entendent hors décoration. Tous les prix sont donnés sans engagement (PVC) et s'entendent en Euro et T. V. A. légale en vigueur non incluse.
© 2023 - Toute reproduction même partielle de ce catalogue est interdite sauf autorisation expresse de Assheuer + Pott GmbH & Co. KG.
Crédit photo: Niklas Thiemann Fotodesign · Stoll GmbH – Studio für Fotografie · track by track GmbH · iStock · Envato Elements Pty Ltd.



buffet | tabletop | bar

Assheuer + Pott GmbH & Co. KG

Talweg 11 | 59846 Sundern
Germany

Phone: +49 (0) 29 33 / 97 35 - 0
E-Mail: info@aps-germany.de

aps-germany.de

KATALOG NR 49
CATALOG NO 49
CATÁLOGO N° 49
CATALOGUE N° 49



Keep in touch!
aps_germany

