



**zafferano**  
LAMPES-À-PORTER

**zafferano**  
LAMPES-À-PORTER

# Indice delle collezioni

## Collections overview

04	10	12	14	16	18
<b>Amelie</b>	Tavolo Table lamp	Terra Floor lamp	Picchetto Lamp with peg	Sospensione Suspension lamp	Parete Wall lamp
20	22	24	26	28	30
<b>Super O</b>	Tavolo Table lamp	Terra Floor lamp	Terra sospesa Ceiling-suspended floor lamp	Sospensione Suspension lamp	Parete Wall lamp
34	40	42	46	48	50
<b>Circe</b>	Tavolo Table lamp	<b>Poldina</b>	Stopper	<b>Lido</b>	Bottiglia Bottle

52	58	60	62	64	
<b>Sister Light Wi-Fi</b>	Tavolo Table lamp	Mini tavolo Mini table lamp	Picchetto Lamp with peg	Parete Wall lamp	
66	68	70	72	74	76
<b>Ofelia</b>	Micro tavolo Micro table lamp	<b>Olivia</b>	Micro tavolo Micro table lamp	<b>Swap</b>	Tavolo Table lamp
78	82	84	85	90	91
<b>Poldina</b>	Parete Wall lamp	Sospensione Suspension lamp	Picchetto Lamp with peg	Tavolo Table lamp	Micro tavolo Micro table lamp
92	94	96	98	100	105
<b>Pina</b>	Tavolo Table lamp	<b>Home Solar</b>	Terra Floor lamp	<b>Liolà</b>	Tavolo Table
106	106	107	111		
<b>Accessori e ricambi</b> Accessories and spares	Accessori Accessories	Basi di ricarica e caricatori Charging bases and chargers	Batterie Battery packs		

# Amelie

Design Sara Moroni



Amelie è una collezione di lampade a batteria, portatili e ricaricabili, che comprende le tipologie da tavolo, terra, parete, a sospensione e con picchetto. Le lampade da tavolo, terra, parete e con picchetto vengono fornite con un tappo in silicone e un gancio, che permettono di trasformarli in una sospensione. Un controllo “touch” presente nella parte superiore della testa permette l'accensione, la regolazione dell'intensità luminosa e la selezione della temperatura di colore della luce tra 2200 K, 2700 K e 3000 K. Grazie a un alto indice di protezione, le lampade della collezione sono utilizzabili anche all'esterno. Sono dotate di base di ricarica a contatto. Caricabatterie non incluso.

Amelie is a collection of portable, rechargeable battery-operated lamps that includes the following models: table, floor, wall and suspension lamps, and lamp with peg. The table, floor and wall lamps and lamp with peg are supplied with a silicone cap and a hook, so that they can be transformed into a suspension lamp. On the head, a touch sensor allows you to switch it on, adjust the luminous intensity and select the color temperature of the light to 2200 K, 2700 K or 3000 K. With the high IP rating, the lamps can also be used outdoors. The lamps come with a contact charging base; battery charger not included.



Amelie table lamp  
leaf green → LD1090V3



Amelie suspension lamp  
leaf green → **LD1091V3**



Amelie wall lamp  
white → **LD1092B3**



Amelie lamp with peg  
terracotta → **LD1094T3**



Amelie floor lamp  
white → **LD1096B3**

**Dati tecnici**

## Technical data

**LED TOUCH DIMMER**

2200-2700-3000 K | CRI>80  
253-300-308 lm | 3 W | IP65  
5 Vdc max 1A



Corpo in pressofusione di alluminio verniciato  
Painted die-cast aluminum body

Schermo diffusore in policarbonato opale  
Opal polycarbonate diffuser

Adatta all'uso esterno (lampada IP65) e interno  
(lampada su base di ricarica IP20)  
Suitable for outdoor (lamp IP65) and indoor use  
(lamp on charging base IP20)

Durata di circa 10 h alla massima potenza  
Battery lasts about 10 h at full power

Tempo di ricarica a 1A: 6 h  
Charging time at 1A: 6 h

Pacco batteria al litio ricaricabile e sostituibile  
Rechargeable and replaceable lithium battery pack

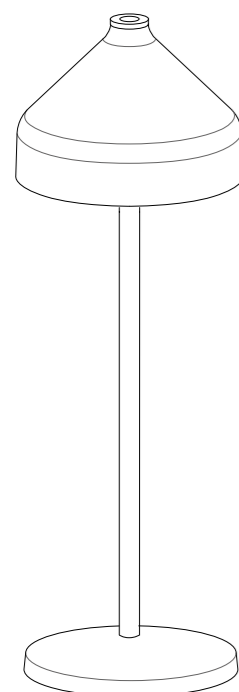

Ø 12 x 34 cm  
Ø 4,7 x 13,3 in

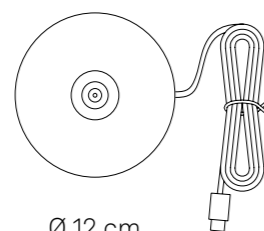

Ø 12 cm  
Ø 4,7 in

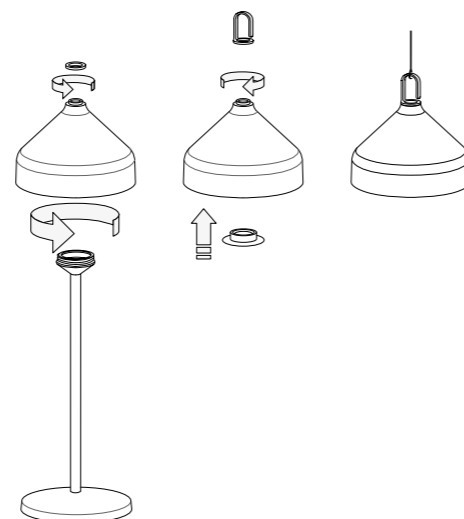
**Componenti inclusi**

## Components included

Base di ricarica a contatto  
Contact charging base

Accessorio per utilizzo a sospensione  
(tappo in silicone e gancio)

Accessories to use as a suspension lamp  
(silicon cap and hook)

**Accessori non inclusi**

## Accessories not included

Caricatore / Charger  
100-240 V | USB Type A  
LD0490UA

**Finiture**

## Finishes



**LD1090B3**  
Bianco / White  
RAL 9016



**LD1090D3**  
Nero / Black  
RAL 9011



**LD1090V3**  
Verde foglia / Leaf green  
RAL 150 60 10



**LD1090T3**  
Terracotta  
Pantone 49-12 C



Amelie table lamp  
terracotta → **LD1090T3**

**Dati tecnici**

## Technical data

**LED TOUCH DIMMER**

2200-2700-3000 K | CRI>80  
253-300-308 lm | 3 W | IP65  
5 Vdc max 1A



Corpo in pressofusione di alluminio verniciato  
Painted die-cast aluminum body

Schermo diffusore in policarbonato opale  
Opal polycarbonate diffuser

Adatta all'uso esterno (lampada IP65) e interno  
(lampada su base di ricarica IP20)  
Suitable for outdoor (lamp IP65) and indoor use  
(lamp on charging base IP20)

Durata di circa 10 h alla massima potenza  
Battery lasts about 10 h at full power

Tempo di ricarica a 1A: 6 h  
Charging time at 1A: 6 h

Pacco batteria al litio ricaricabile e sostituibile  
Rechargeable and replaceable lithium battery pack

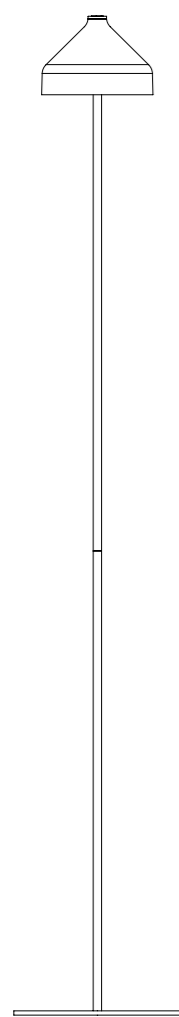
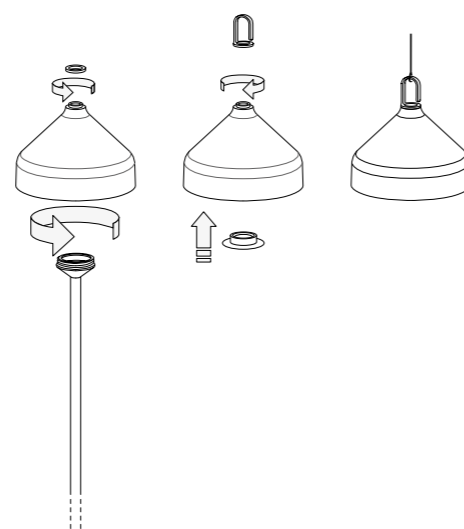

Ø 20 x 120 cm  
Ø 7,8 x 47 in

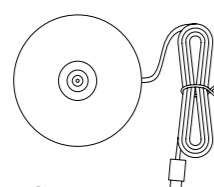

Ø 12 cm  
Ø 4,7 in

**Componenti inclusi**

## Components included

Base di ricarica a contatto  
Contact charging base

Accessorio per utilizzo a sospensione  
(tappo in silicone e gancio)

Accessories to use as a suspension lamp  
(silicon cap and hook)

**Accessori non inclusi**

## Accessories not included

Caricatore / Charger  
100-240 V | USB Type A  
LD0490UA

**Finiture**

## Finishes

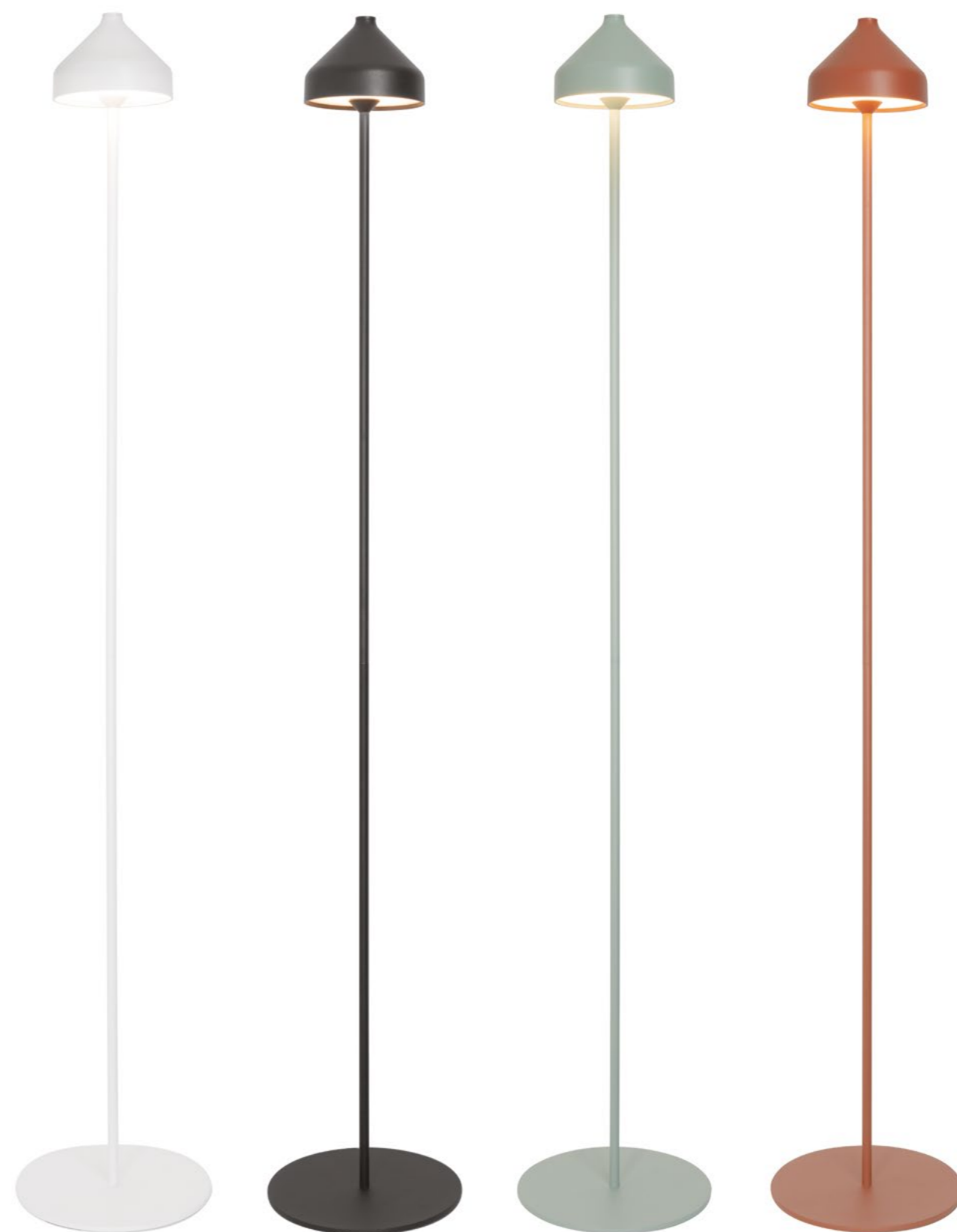

**LD1096B3**  
Bianco / White  
RAL 9016

**LD1096D3**  
Nero / Black  
RAL 9011

**LD1096V3**  
Verde foglia / Leaf green  
RAL 150 60 10

**LD1096T3**  
Terracotta  
Pantone 49-12 C



**Dati tecnici**

## Technical data

**LED TOUCH DIMMER**

2200-2700-3000 K | CRI&gt;80

253-300-308 lm | 3 W | IP65

5 Vdc max 1A

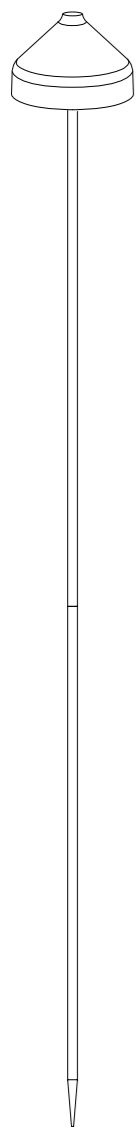

Ø 12 x 120 cm  
Ø 4,7 x 47 in

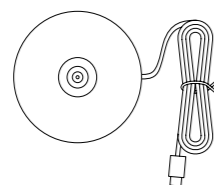

Ø 12 cm  
Ø 4,7 in

Corpo in pressofusione di alluminio verniciato

Painted die-cast aluminum body

Schermo diffusore in policarbonato opale

Opal polycarbonate diffuser

Adatta all'uso esterno (lampada IP65) e interno (lampada su base di ricarica IP20)

Suitable for outdoor (lamp IP65) and indoor use (lamp on charging base IP20)

Durata di circa 10 h alla massima potenza

Battery lasts about 10 h at full power

Tempo di ricarica a 1A: 6 h

Charging time at 1A: 6 h

Pacco batteria al litio ricaricabile e sostituibile

Rechargeable and replaceable lithium battery pack

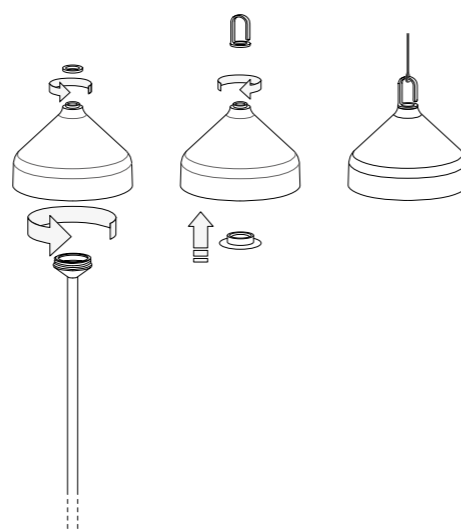
**Componenti inclusi**

Components included

Base di ricarica a contatto

Contact charging base

Accessorio per utilizzo a sospensione (tappo in silicone e gancio)

Accessories to use as a suspension lamp (silicon cap and hook)

**Accessori non inclusi**

Accessories not included

Caricatore / Charger

100-240 V | USB Type A

LD0490UA

**Finiture**

## Finishes



**LD1094B3**  
Bianco / White  
RAL 9016



**LD1094D3**  
Nero / Black  
RAL 9011



**LD1094V3**  
Verde foglia / Leaf green  
RAL 150 60 10



**LD1094T3**  
Terracotta  
Pantone 49-12 C

**Dati tecnici**

## Technical data

**LED TOUCH DIMMER**

2200-2700-3000 K | CRI>80  
253-300-308 lm | 3 W | IP65  
5 Vdc max 1A



Corpo in pressofusione di alluminio verniciato  
Painted die-cast aluminum body

Schermo diffusore in policarbonato opale  
Opal polycarbonate diffuser

Adatta all'uso esterno (lampada IP65) e interno  
(lampada su base di ricarica IP20)  
Suitable for outdoor (lamp IP65) and indoor use  
(lamp on charging base IP20)

Durata di circa 10 h alla massima potenza  
Battery lasts about 10 h at full power

Tempo di ricarica a 1A: 6 h  
Charging time at 1A: 6 h

Pacco batteria al litio ricaricabile e sostituibile  
Rechargeable and replaceable lithium battery pack

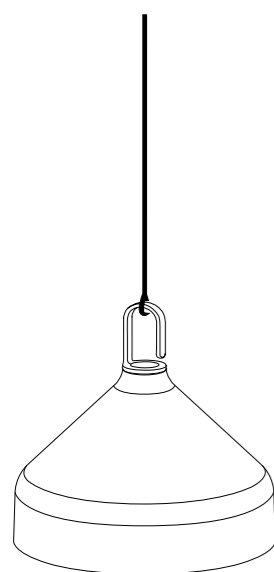

Ø 12 x 12 cm  
Ø 4,7 x 4,7 in

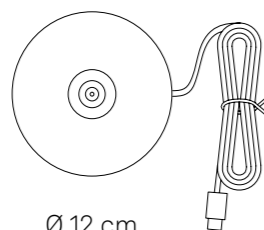

Ø 12 cm  
Ø 4,7 in

**Componenti inclusi**

Components included

Base di ricarica a contatto  
Contact charging base

Tappo in silicone e gancio  
Silicon cap and hook

**Accessori non inclusi**

Accessories not included

Caricatore / Charger  
100-240 V | USB Type A  
LD0490UA

**Finiture**

## Finishes

**LD1091B3**

Bianco / White  
RAL 9016

**LD1091D3**

Nero / Black  
RAL 9011

**LD1091V3**

Verde foglia / Leaf green  
RAL 150 60 10

**LD1091T3**

Terracotta  
Pantone 49-12 C



**Dati tecnici**

## Technical data

**LED TOUCH DIMMER**

2200-2700-3000 K | CRI>80  
253-300-308 lm | 3 W | IP65  
5 Vdc max 1A



Corpo in pressofusione di alluminio verniciato  
Painted die-cast aluminum body

Schermo diffusore in policarbonato opale  
Opal polycarbonate diffuser

Adatta all'uso esterno (lampada IP65) e interno  
(lampada su base di ricarica IP20)  
Suitable for outdoor (lamp IP65) and indoor use  
(lamp on charging base IP20)

Durata di circa 10 h alla massima potenza  
Battery lasts about 10 h at full power

Tempo di ricarica a 1A: 6 h  
Charging time at 1A: 6 h

Pacco batteria al litio ricaricabile e sostituibile  
Rechargeable and replaceable lithium battery pack

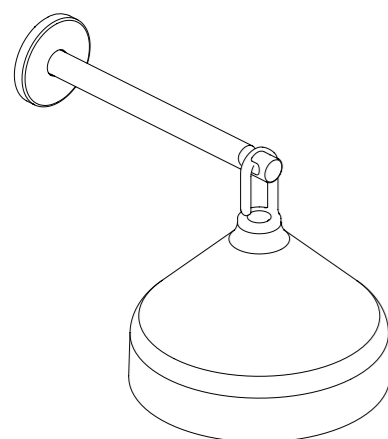

20 x 12 x 14 cm  
7,8 x 4,7 x 5,5 in

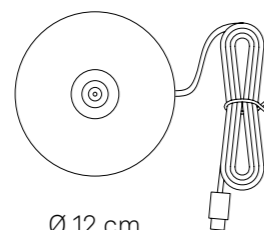

Ø 12 cm  
Ø 4,7 in

**Componenti inclusi**

Components included

Base di ricarica a contatto  
Contact charging base

Tappo in silicone e gancio  
Silicon cap and hook

**Accessori non inclusi**

Accessories not included

Caricatore / Charger  
100-240 V | USB Type A  
LD0490UA

**Finiture**

## Finishes

**LD1092B3**

Bianco / White  
RAL 9016

**LD1092D3**

Nero / Black  
RAL 9011

**LD1092V3**

Verde foglia / Leaf green  
RAL 150 60 10

**LD1092T3**

Terracotta  
Pantone 49-12 C



# Super O

Design Studio Kairos



Super O è una collezione di lampade a batteria, portatili e ricaricabili che comprende le tipologie da tavolo, terra (in tre modelli), terra sospesa (in tre modelli), parete (in due modelli) e a sospensione. Il modulo luminoso si fissa alla montatura di ciascun modello tramite un magnete, e - ruotando a 360° - permette di orientare la luce. Un controllo "touch" presente nella parte superiore del modulo permette l'accensione, la regolazione dell'intensità luminosa (dimmerazione a 4 step) e la selezione della temperatura di colore della luce tra 2700 K, 3150 K e 4000 K. Grazie a un alto indice di protezione, le lampade della collezione sono utilizzabili anche all'esterno. Possiedono un sistema di controllo elettronico che monitora l'autonomia residua e garantisce un flusso luminoso costante fino all'esaurimento della batteria, permettendo di ottimizzare le ricariche ed effettuarle sempre in maniera corretta. Il modulo si rimuove in modo pratico e si ricarica comodamente connettendolo all'apposito disco di ricarica a contatto. Caricabatterie non incluso.

Super O is a collection of portable, rechargeable battery-operated lamps that includes the following: table, floor (three models), ceiling-suspended floor (three models) and wall (two models) lamps, and a suspension lamp. The lighting module is attached to the frame of the lamps with a magnet. It can rotate 360°, allowing to direct the flow of light. On the head, a touch sensor allows you to switch it on, adjust the luminous intensity (4-step: 100%, 60%, 30%, 6%) and select the color temperature of the light to 2700 K, 3150 K or 4000 K. With the high IP rating, the lamps can also be used outdoors. They feature an electronic control system that monitors the remaining autonomy and ensures a constant luminous flux until the battery runs out; recharging is therefore optimized and always properly done. The module can be easily removed from the frame and conveniently recharged by connecting it to the contact charging base; battery charger not included.



**Dati tecnici**

## Technical data

**LED TOUCH DIMMER**

2700-3150-4000 K | CRI>90  
287-331-336 lm | 3,5 W | IP65  
5 Vdc max 2A

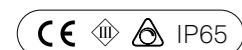

Corpo in pressofusione di alluminio verniciato  
Painted die-cast aluminum body

Schermo diffusore in policarbonato prismatico  
Prismatic polycarbonate diffuser

Adatta all'uso esterno (lampada IP65) e interno  
Suitable for outdoor (lamp IP65) and indoor use

Durata di 10 - 160 h, in base alla regolazione  
del flusso luminoso  
Battery lasts 10 - 160 h, depending on the  
luminous flux setting

Tempo di ricarica a 2A: 5 h  
Charging time at 2A: 5 h

Pacco batteria al litio ricaricabile e sostituibile  
Rechargeable and replaceable lithium battery pack

**Finiture**

## Finishes



**LD1152B3**  
Bianco / White  
RAL 9003



**LD1152N3**  
Nero / Black  
RAL 9005

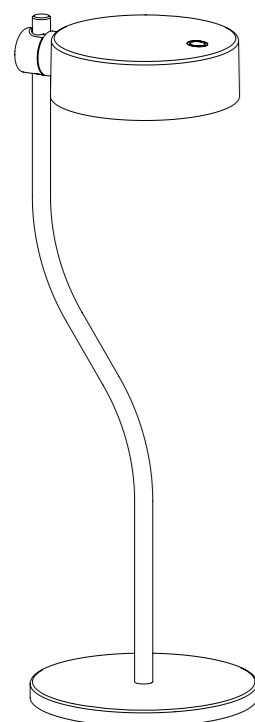

16,6 x 15 x 46 cm  
6,5 x 5,9 x 18,1 in

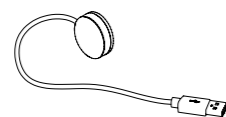

Ø 3 x 1 cm  
Ø 1,2 x 0,4 in

**Componenti inclusi**

Components included

Disco per ricarica a contatto  
Contact charging puck

**Accessori non inclusi**

Accessories not included

Caricatore / Charger  
100-240 V | USB Type A (LD0300UC)



Super O table lamp  
white → **LD1152B3**

**Dati tecnici**

## Technical data

**LED TOUCH DIMMER**

2700-3150-4000 K | CRI>90  
287-331-336 lm | 3,5 W | IP65  
5 Vdc max 2A

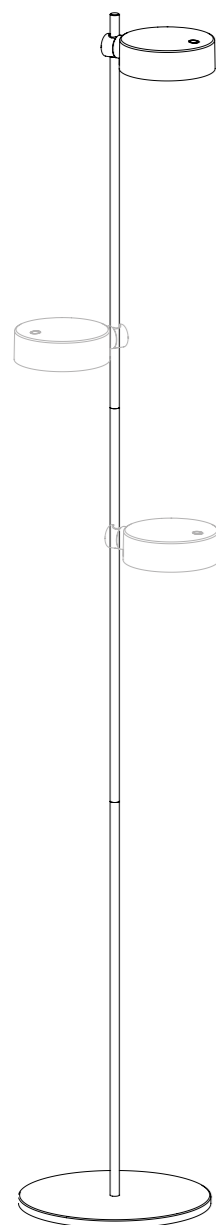

Ø 25 x 160 cm  
Ø 9,8 x 63 in

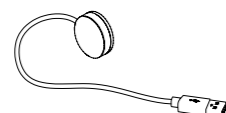

Ø 3 x 1 cm  
Ø 1,2 x 0,4 in

Corpo in pressofusione di alluminio verniciato  
Painted die-cast aluminum body

Schermo diffusore in policarbonato prismatico  
Prismatic polycarbonate diffuser

Adatta all'uso esterno (lampada IP65) e interno  
Suitable for outdoor (lamp IP65) and indoor use

Durata di 10 - 160 h, in base alla regolazione  
del flusso luminoso  
Battery lasts 10 - 160 h, depending on the  
luminous flux setting

Tempo di ricarica a 2A: 5 h  
Charging time at 2A: 5 h

Pacco batteria al litio ricaricabile e sostituibile  
Rechargeable and replaceable lithium battery pack

**Finiture**

## Finishes



Bianco / White  
RAL 9003

1 Modulo luce  
1 Lighting module

**LD1154B3**

2 Moduli luce  
2 Lighting modules

**LD1155B3**

3 Moduli luce  
3 Lighting modules

**LD1156B3**



Nero / Black  
RAL 9005

1 Modulo luce  
1 Lighting module

**LD1154N3**

2 Moduli luce  
2 Lighting modules

**LD1155N3**

3 Moduli luce  
3 Lighting modules

**LD1156N3**

**Accessori non inclusi**

Accessories not included

Caricatore / Charger  
100-240 V | USB Type A (LD0300UC)

**Componenti inclusi**

Components included

Disco per ricarica a contatto  
Contact charging puck

Super O floor lamp  
(2 Lighting modules) black → **LD1155N3**



**Dati tecnici**

## Technical data

**LED TOUCH DIMMER**

2700-3150-4000 K | CRI>90  
287-331-336 lm | 3,5 W | IP65  
5 Vdc max 2A

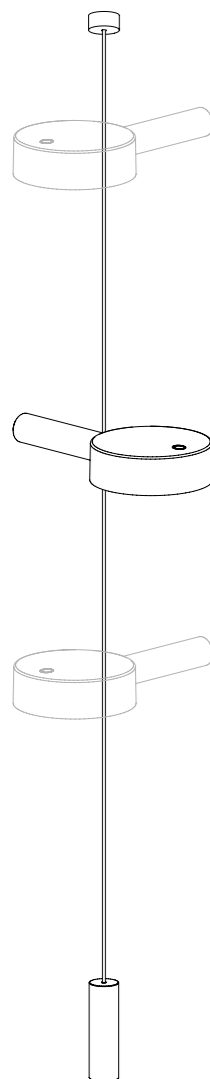

12,5 x 24,7 x 500 cm  
4,9 x 9,7 x 196,9 in

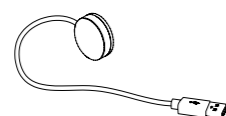

Ø 3 x 1 cm  
Ø 1,2 x 0,4 in

Corpo in pressofusione di alluminio verniciato  
Painted die-cast aluminum body

Schermo diffusore in policarbonato prismatico  
Prismatic polycarbonate diffuser

Adatta all'uso esterno (lampada IP65) e interno  
Suitable for outdoor (lamp IP65) and indoor use

Durata di 10 - 160 h, in base alla regolazione  
del flusso luminoso  
Battery lasts 10 - 160 h, depending on the  
luminous flux setting

Tempo di ricarica a 2A: 5 h  
Charging time at 2A: 5 h

Pacco batteria al litio ricaricabile e sostituibile  
Rechargeable and replaceable lithium battery pack

**Finiture**

## Finishes



Bianco / White  
RAL 9003

1 Modulo luce  
1 Lighting module  
**LD1157B3**

2 Moduli luce  
2 Lighting modules  
**LD1158B3**

3 Moduli luce  
3 Lighting modules  
**LD1159B3**



Nero / Black  
RAL 9005

1 Modulo luce  
1 Lighting module  
**LD1157N3**

2 Moduli luce  
2 Lighting modules  
**LD1158N3**

3 Moduli luce  
3 Lighting modules  
**LD1159N3**

**Componenti inclusi**

## Components included

Disco per ricarica a contatto / Contact charging puck

Cavo di colore grigio scuro / Dark gray cable

Cavo di colore rosso / Red cable

Contrappeso da terra / Floor counterweight

Contrappeso modulo luce

Counterweight for lighting module

**Accessori non inclusi**

## Accessories not included

Caricatore / Charger

100-240 V | USB Type A (LD0300UC)



Super O ceiling-suspended  
floor lamp (1 Lighting module)  
black → **LD1157N3**

**Dati tecnici**

## Technical data

**LED TOUCH DIMMER**

2700-3150-4000 K | CRI>90  
287-331-336 lm | 3,5 W | IP65  
5 Vdc max 2A



Corpo in pressofusione di alluminio verniciato  
Painted die-cast aluminum body

Schermo diffusore in policarbonato prismatico  
Prismatic polycarbonate diffuser

Adatta all'uso esterno (lampada IP65) e interno  
Suitable for outdoor (lamp IP65) and indoor use

Durata di 10 - 160 h, in base alla regolazione  
del flusso luminoso  
Battery lasts 10 - 160 h, depending on the  
luminous flux setting

Tempo di ricarica a 2A: 5 h  
Charging time at 2A: 5 h

Pacco batteria al litio ricaricabile e sostituibile  
Rechargeable and replaceable lithium battery pack

**Finiture**

## Finishes



**LD1153B3**  
Bianco / White  
RAL 9003



**LD1153N3**  
Nero / Black  
RAL 9005

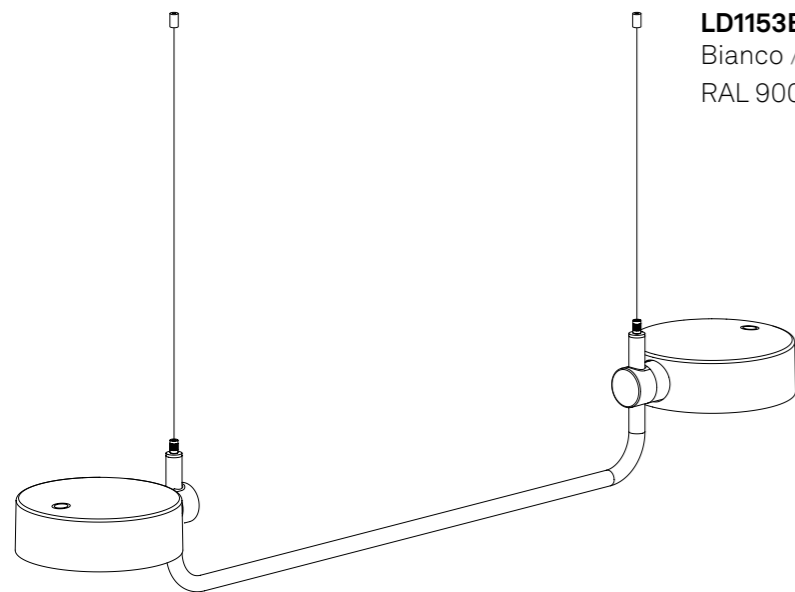

77 x 12,5 x 300 cm  
30,3 x 4,9 x 118,1 in

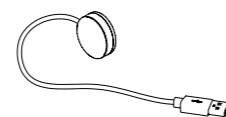

Ø 3 x 1 cm  
Ø 1,2 x 0,4 in

**Componenti inclusi**

Components included

Disco per ricarica a contatto  
Contact charging puck

**Accessori non inclusi**

Accessories not included

Caricatore / Charger  
100-240 V | USB Type A (LD0300UC)



Super O suspension lamp  
white → **LD1153B3**



**Dati tecnici****Technical data****LED TOUCH DIMMER**

2700-3150-4000 K | CRI>90  
287-331-336 lm | 3,5 W | IP65  
5 Vdc max 2A



Corpo in pressofusione di alluminio verniciato  
Painted die-cast aluminum body

Schermo diffusore in policarbonato prismatico  
Prismatic polycarbonate diffuser

Adatta all'uso esterno (lampada IP65) e interno  
Suitable for outdoor (lamp IP65) and indoor use

Durata di 10 - 160 h, in base alla regolazione  
del flusso luminoso

Battery lasts 10 - 160 h, depending on the  
luminous flux setting

Tempo di ricarica a 2A: 5 h

Charging time at 2A: 5 h

Pacco batteria al litio ricaricabile e sostituibile

Rechargeable and replaceable lithium battery pack

**Finiture****Finishes**

**LD1151B3**  
Bianco / White  
RAL 9003



**LD1151N3**  
Nero / Black  
RAL 9005

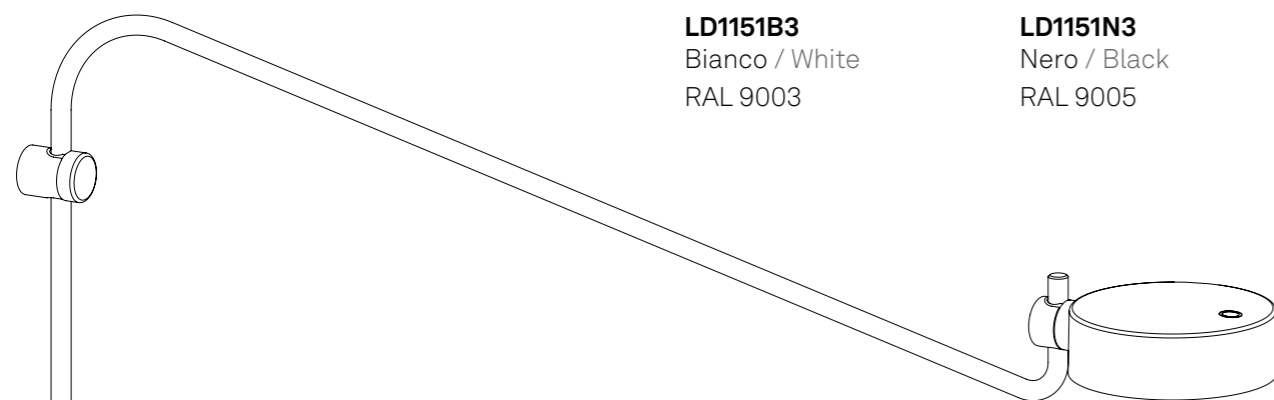

12,5 x 40,5 x 85,3 cm  
4,9 x 15,9 x 33,6 in

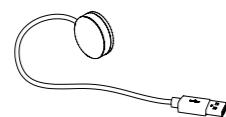

Ø 3 x 1 cm  
Ø 1,2 x 0,4 in

**Componenti inclusi**

Components included

Disco per ricarica a contatto  
Contact charging puck

**Accessori non inclusi**

Accessories not included

Caricatore / Charger  
100-240 V | USB Type A (LD0300UC)



Super O wall lamp  
white → **LD1151B3**

**Dati tecnici**

## Technical data

**LED TOUCH DIMMER**

2700-3150-4000 K | CRI>90  
287-331-336 lm | 3,5 W | IP65  
5 Vdc max 2A



Corpo in pressofusione di alluminio verniciato  
Painted die-cast aluminum body

Schermo diffusore in policarbonato prismatico  
Prismatic polycarbonate diffuser

Adatta all'uso esterno (lampada IP65) e interno  
Suitable for outdoor (lamp IP65) and indoor use

Durata di 10 - 160 h, in base alla regolazione  
del flusso luminoso

Battery lasts 10 - 160 h, depending on the  
luminous flux setting

Tempo di ricarica a 2A: 5 h

Charging time at 2A: 5 h

Pacco batteria al litio ricaricabile e sostituibile

Rechargeable and replaceable lithium battery pack

**Finiture**

## Finishes

**LD1150B3**

Bianco / White  
RAL 9003

**LD1150N3**

Nero / Black  
RAL 9005

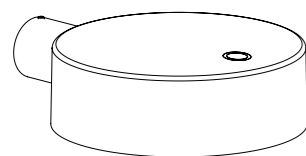

12,5 x 4,3 x 16,2 cm  
4,9 x 1,7 x 6,4 in

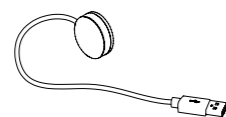

Ø 3 x 1 cm  
Ø 1,2 x 0,4 in

**Componenti inclusi**

Components included

Disco per ricarica a contatto  
Contact charging puck

**Accessori non inclusi**

Accessories not included

Caricatore / Charger  
100-240 V | USB Type A (LD0300UC)



Super O wall lamp  
black → **LD1150N3**

# Circe

## Tavolo pro

Table lamp pro



Circe è una lampada da tavolo a batteria, portatile e ricaricabile. Nella parte superiore della testa è presente un pulsante che permette l'accensione, la regolazione dell'intensità luminosa e la selezione della temperatura di colore della luce tra 2200 K e 3000 K (bianco dinamico). Grazie ad un alto indice di protezione, la lampada è utilizzabile anche all'esterno (ad eccezione dei modelli con finitura galvanica, dei quali è sconsigliato l'uso continuativo in esterni). È dotata di base di ricarica a contatto. Caricabatterie non incluso.

Circe is a rechargeable battery-powered cordless table lamp. The knob on the top of the lampshade allows switching on/off, dimming, and tuning the color temperature of the light between 2200 K and 3000 K (Dynamic Tunable White). It is suitable for both indoor and outdoor use (except gold and rose gold finishes). Circe comes with a contact charging base; the battery charger is not included.



Circe table lamp  
white → LD1005B3



Circe table lamp  
corten → **LD1005R3**

Circe table lamp  
white → **LD1005B3**





Circe table lamp  
black → **LD1005N3**

Circe table lamp glossy  
rose gold → **LD1005E3**

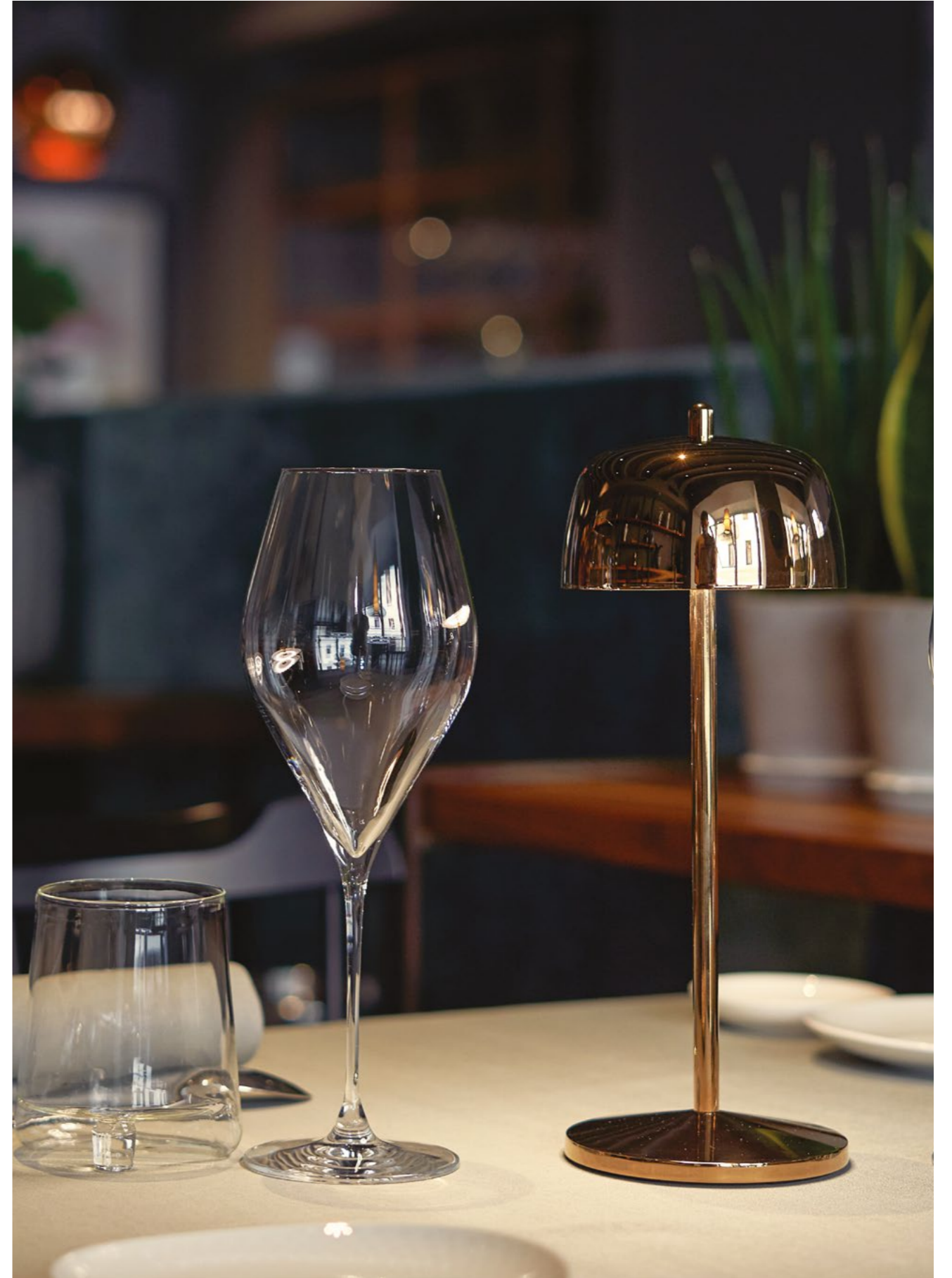

**Dati tecnici**

## Technical data

**LED DIMMER**

2200-3000 K | CRI>80  
214-224 lm | 2,2 W | IP65  
5 Vdc max 1A



Corpo in pressofusione di alluminio verniciato  
Painted die-cast aluminum body

Schermo diffusore in policarbonato prismatico  
Prismatic polycarbonate diffuser

Adatta all'uso esterno (lampada IP65) e interno  
(lampada su base di ricarica IP20)  
Suitable for outdoor (lamp IP65) and indoor use  
(lamp on charging base IP20)

Durata di circa 9 h alla massima potenza  
Battery lasts about 9 h at full power

Tempo di ricarica a 1A: 6 h  
Charging time at 1A: 6 h

Pacco batteria al litio ricaricabile e sostituibile  
Rechargeable and replaceable lithium battery pack

**Avvertenze**

## Remarks

Le lampade con finitura galvanica lucida oro e oro rosa non sono adatte per uso esterno.  
The lamps with gold and rose gold glossy galvanic finish are not suitable for outdoor use.

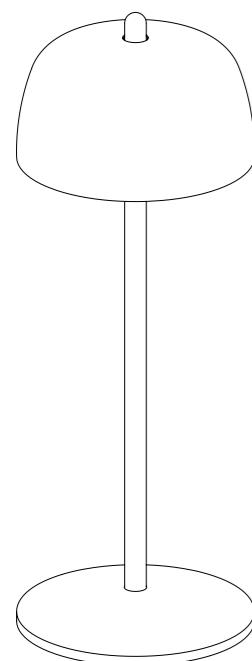

Ø 11 x 30 cm  
Ø 4,3 x 11,8 in

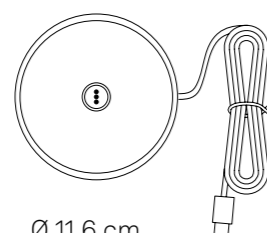

Ø 11,6 cm  
Ø 4,5 in

**Accessori inclusi**

Accessories included

Base di ricarica a contatto  
Contact charging base

**Accessori non inclusi**

Accessories not included

Caricatore / Charger  
100-240 V | USB Type A  
LD0490UA

**Finiture**

## Finishes

**LD1005B3**

Bianco / White  
RAL 9002

**LD1005R3**

Corten

**LD1005N3**

Nero / Black  
RAL 9005

**LD1005O3**

Oro lucido / Glossy gold  
Galvanic finish

**LD1005E3**

Oro rosa lucido / Glossy rose gold  
Galvanic finish

Le lampade con finitura galvanica lucida oro e oro rosa non sono adatte per uso esterno.  
The lamps with gold and rose gold glossy galvanic finish are not suitable for outdoor use.

# Poldina

## Stopper



Poldina è una lampada a batteria, portatile e ricaricabile, con tappo in silicone, che si può inserire su una bottiglia, trasformandola in un oggetto luminoso. Nella parte superiore della testa è presente un controllo "touch", che permette l'accensione, la regolazione dell'intensità luminosa e la selezione della temperatura di colore della luce tra 2200K, 2700K e 3000K. Grazie a un alto indice di protezione, la lampada è utilizzabile anche all'esterno. Possiede un sistema di controllo elettronico che monitora e segnala l'autonomia residua della batteria, permettendo di ottimizzare le ricariche ed effettuarle sempre in maniera corretta. Il tappo in silicone (adatto al contatto alimentare) si adatta a diversi colli di bottiglia e si rimuove in modo pratico, permettendo di ricaricare comodamente la lampada sulla propria base di ricarica a contatto; caricabatterie non incluso. Poldina Stopper è utilizzabile anche con le bottiglie in ceramica "Lido", acquistabili separatamente (pag. 48).

Poldina is a rechargeable battery-operated, cordless lamp. Thanks to a silicone stopper cork, the lamp can be placed on a bottle, turning it into a luminous object. A "touch" control on the head allows switching on/off, dimming, and selecting the color temperature of the light (2200K, 2700K, or 3000K). It is suitable for both indoor and outdoor use. An electronic control system monitors the remaining autonomy and ensures a constant luminous flux until the battery runs out. Recharging is therefore optimized and always properly done. The silicone cap (suitable for food contact) fits different bottle necks and can be easily removed, allowing the lamp to be conveniently recharged on its contact charging base; battery charger not included. Poldina Stopper can also be used with "Lido" ceramic bottles, which can be purchased separately (page 48).



Poldina Stopper black → **LD0349D3**  
Lido ceramic bottle black → **FAS1508**



Poldina Stopper black → **LD0349D3**  
Lido ceramic bottle black → **FAS1508**

Poldina Stopper sand → **LD0349S3**  
Lido ceramic bottle sand → **FAS1507 + PUN1507**





**Dati tecnici**

Technical data

**LED TOUCH DIMMER**

2200-2700-3000 K | CRI>80  
234-251-256 lm | 2,2 W | IP54  
5 Vdc max 1A



Ø 2,5 x 3,8 cm  
Ø 1 x 1,5 in

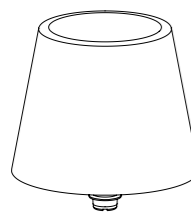

Ø 11,1 x 11,1 cm  
Ø 4,4 x 4,4 in

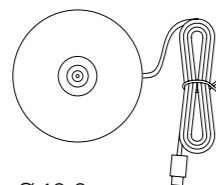

Ø 10,2 cm  
Ø 4 in

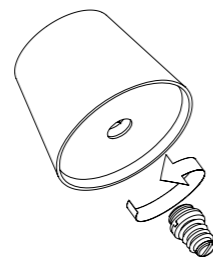

Corpo in pressofusione di alluminio verniciato  
Painted die-cast aluminum body

Schermo diffusore in policarbonato  
Polycarbonate diffuser

Tappo in silicone  
Silicon cover

Adatta all'uso esterno (lampada IP54) e interno  
Suitable for outdoor (lamp IP54) and indoor use

Durata di circa 12 h alla massima potenza  
Battery lasts about 12 h at full power

Tempo di ricarica a 1A: 6/7 h  
Charging time at 1A: 6/7 h

Pacco batteria al litio ricaricabile e sostituibile  
Rechargeable and replaceable lithium battery pack

**Finiture**

Finishes



**LD0349B3**  
Bianco / White  
RAL 9003



**LD0349A3**  
Blu avio / Avio blue  
Pantone 7468 U



**LD0349F3**  
Rosso / Red  
RAL 3000



**LD0349G3**  
Salvia / Sage green  
Pantone 5635 U



**LD0349S3**  
Sabbia / Sand



**LD0349D3**  
Nero / Black  
RAL 9004

**Componenti inclusi**

Components included

Base di ricarica a contatto  
Contact charging base

Tappo in silicone per Poldina / Poldina silicon cover

**Accessori non inclusi**

Accessories not included

Caricatore / Charger  
100-240 V | USB Type A  
LD0490UA



Poldina Stopper Avio blue → **LD0349A3**  
Lido ceramic bottle light blue → **RIG1508**

# Lido

Design Federico de Majo

## Bottiglia in ceramica Ceramic bottle



Bottiglia in ceramica, nella cui imboccatura si può alloggiare la lampada Poldina Stopper.

È prodotta in tre modelli, diversi tra loro per forma e motivo decorativo; ciascun modello è disponibile in cinque colori, con tappo sferico in tinta.

La stretta collaborazione con un'antica fabbrica di Civita Castellana – borgo viterbese dove l'arte della ceramica è attestata fin dal X secolo a.C. – consente a Zafferano di avvalersi di una produzione esclusiva di manufatti "Made in Italy", decorati a mano su disegno proprio.

Ceramic bottle in whose mouth the Poldina Stopper lamp can be placed.

It is produced in three models, different in shape and decorative motif; each model is available in five colors, with matching spherical cap.

The close collaboration with an ancient factory in Civita Castellana, a village in the Viterbo area where the art of ceramics has been attested since the 10th century B.C., allows Zafferano to take advantage of an exclusive production of "Made in Italy" artifacts, hand-decorated according to its own design.



Lido ceramic bottle green → FAS1505

## Dati tecnici

### Technical data

Ceramica decorata a mano  
Hand-painted ceramic

Tappo ermetico, in materiale plastico,  
adatto al contatto alimentare  
Airtight plastic stopper, suitable for  
food contact

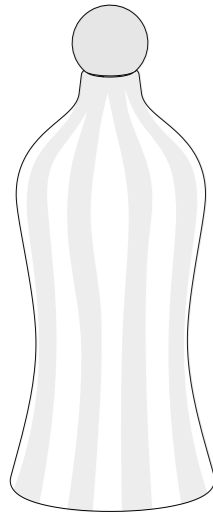

Ø 11 x 26,5 cm  
Ø 4,3 x 10,4 in  
90 cl

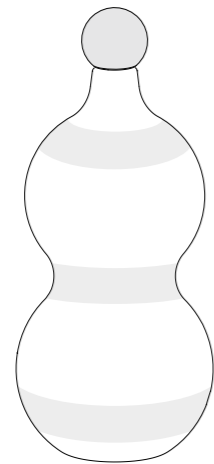

Ø 10,4 x 24,5 cm  
Ø 4,1 x 9,6 in  
82 cl

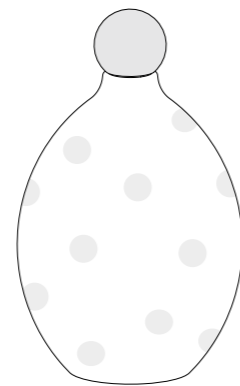

Ø 13 x 20,5 cm  
Ø 5,1 x 8,1 in  
114 cl



## Finiture

### Finishes



**RIG1501**  
Righe azzurre  
Light blue stripes



**RIG1502**  
Righe rosse  
Red stripes



**RIG1505**  
Righe verdi  
Green stripes



**RIG1507**  
Righe sabbia  
Sand stripes



**RIG1508**  
Righe nere  
Black stripes



**FAS1501**  
Fasce azzurre  
Light blue bands



**FAS1502**  
Fasce rosse  
Red bands



**FAS1505**  
Fasce verdi  
Green bands



**FAS1507**  
Fasce sabbia  
Sand bands



**FAS1508**  
Fasce nere  
Black bands



**PUN1501**  
Pois azzurri  
Light blue dots



**PUN1502**  
Pois rossi  
Red dots



**PUN1505**  
Pois verdi  
Green dots



**PUN1507**  
Pois sabbia  
Sand dots



**PUN1508**  
Pois neri  
Black dots

# Sister Light

WI-FI

Design Federico de Majo



Video Sister  
Light Wi-Fi ↗



Sister Light Wi-Fi è una nuova collezione di lampade a batteria, portatili e ricaricabili, controllabili anche da remoto mediante l'utilizzo dell'applicazione Zafferano Lighting. La collezione comprende le tipologie da tavolo (in due altezze), parete e con picchetto. Un controllo "touch" presente nella parte superiore della testa permette accensione, dimmerazione a 4 step e selezione della temperatura di colore della luce (2200 K, 2700 K, 3000 K e 4000 K). L'app permette molti controlli aggiuntivi (\*). Grazie all'indice di protezione IP65, sono utilizzabili anche all'esterno; sono inoltre resistenti alla nebbia salina (1500 h). Possiedono un sistema di controllo elettronico che monitora l'autonomia residua e garantisce un flusso luminoso costante fino all'esaurimento della batteria, permettendo di ottimizzare le ricariche ed effettuarle sempre in maniera corretta. Tutti i modelli si ricaricano svitando la testa e ponendola sulla base di ricarica a contatto, inclusa; i modelli da tavolo si ricaricano anche appoggiando la lampada sulla base di ricarica a contatto. Caricabatterie non incluso.

Sister Light Wi-Fi is a new collection of portable, rechargeable battery-operated lamps that can be remote controlled using the Zafferano Lighting app. The collection includes the following models: table lamp (two heights), wall lamp and lamp with peg. On the head, a touch control allows you to turn it on/off, dim (4-step: 100%, 60%, 30%, 6%) and select the color temperature of the light among 2200 K, 2700 K, 3000 K and 4000 K. Many additional controls are available in app (\*). With their IP65 rating, the lamps can also be used outdoors; they are salt spray resistant (1500 h). All models feature an electronic control system that monitors the remaining autonomy and ensures a constant luminous flux until the battery runs out. Recharging is therefore optimized and always properly done. All models can be recharged by unscrewing the top and positioning it on the contact charging base, included. The table versions can be recharged also by positioning the whole lamp on the contact charging base. Battery charger not included.

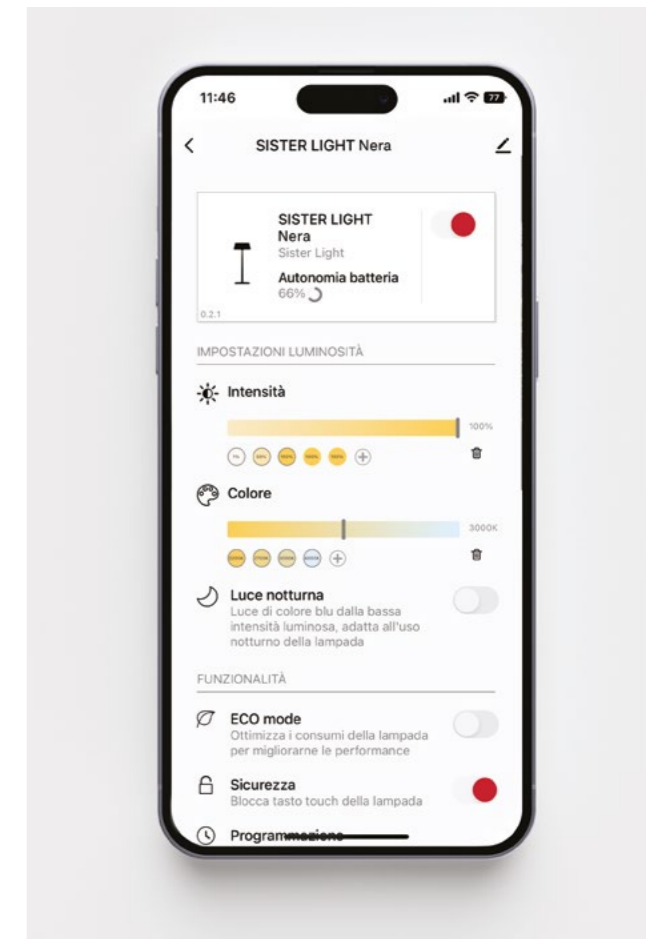

## (\* Zafferano Lighting App

- Creare e controllare gruppi di lampade
- Dimmer 1-100 con possibilità di creare step personalizzati
- Bianco dinamico (2200K-4000K) con possibilità di creare step personalizzati
- Disabilitazione del "touch" di controllo
- Controllo del livello di carica della batteria
- Timer spegnimento lampada
- Luce notturna
- Eco-Mode
- Disabilitazione del LED di stato
- Definizione tempo di connessione al Wi-Fi
- Modalità emergenza
- Grouping lamps for all-at-once control
- Dimming 1-100 and preset custom dim levels
- Tunable Dynamic White (2200K-4000K) and preset custom color temperature levels
- Disabling touch control
- Monitoring battery charge level
- Time programming (lamp off)
- Activating night light
- Activating Eco Mode
- Disabling status LED
- Wi-Fi connection time-setting
- Activating Emergency Mode



Download Zafferano Lighting App



Sister Light Wi-Fi  
table lamp ivory → **LD108013**



Sister Light Wi-Fi  
wall lamp copper → **LD1082R3**



Sister Light Wi-Fi  
table lamp mini gold → **LD108103**



Sister Light Wi-Fi lamp with peg  
pearly white → **LD1083B3**

**Dati tecnici**

## Technical data

**LED TOUCH DIMMER**

2200-2700-3000-4000 K | CRI>90  
250-275-296-338 lm | 3,2 W | IP65  
5 Vdc max 2A



Corpo in alluminio anodizzato spazzolato  
(oro, rame, verde) oppure verniciato  
(bianco perlato, nero perlato, avorio)  
Brushed anodized (gold, copper, green) or painted  
aluminum body (pearly white, pearly black, ivory)

Diffusore in policarbonato prismatico  
Prismatic polycarbonate diffuser

Adatta all'uso esterno (lampada IP65) e interno  
(lampada su base di ricarica IP20)  
Suitable for outdoor (lamp IP65) and indoor use  
(lamp on charging base IP20)

Resistenza agli urti (IK07) e alla nebbia salina (1500h)  
Impact resistance (IK07) and salt spray resistance  
(1500h)

Durata 8 - 58 h, in base alla regolazione del flusso  
luminoso e alle impostazioni del Wi-Fi  
Battery lasts 8 - 58 h, depending on the luminous  
flux and Wi-Fi setting

Tempo di ricarica a 2A: 5 h  
Charging time at 2A: 5 h

Pacco batteria al litio ricaricabile e sostituibile  
Rechargeable and replaceable lithium battery pack

**AVVERTENZE / REMARKS**

Per poter funzionare, la lampada deve essere  
collegata a una rete Wi-Fi con frequenza 2,4 GHz.  
In order to work, the lamp must be connected  
to a 2.4 GHz frequency Wi-Fi network.

Firmware del dispositivo aggiornabile da remoto.  
Remotely upgradable device firmware.

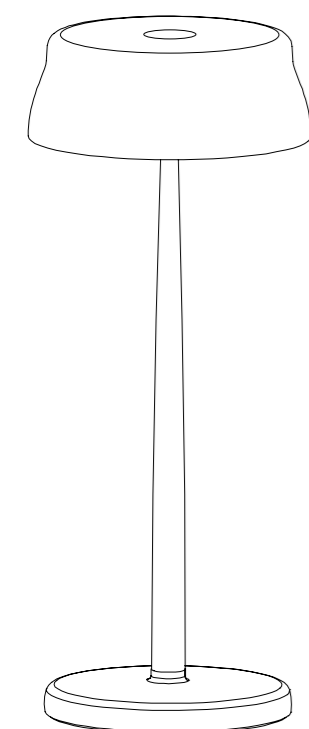

Ø 13,2 x 33 cm  
Ø 5,2 x 13 in

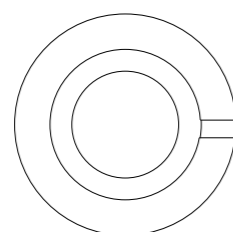

Ø 11,3 cm  
Ø 4,4 in

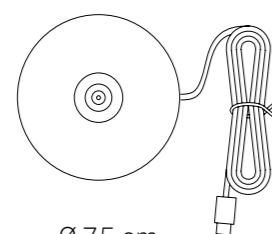

Ø 7,5 cm  
Ø 3 in

**Componenti inclusi**

Components included

Base di ricarica a contatto  
Contact charging base

Adattatore per base di ricarica a contatto  
Contact charging base adapter

**Accessori non inclusi**

Accessories not included

Caricatore / Charger  
100-240 V | USB Type A  
LD0300UC

**Finiture**

## Finishes



**LD108003**  
Oro / Gold



**LD1080R3**  
Rame / Copper



**LD1080V3**  
Verde / Green



**LD1080B3**  
Bianco perlato / Pearly white  
RAL 9010



**LD1080D3**  
Nero perlato / Pearly black  
RAL 9011



**LD1080I3**  
Avorio / Ivory  
RAL 1015

**Dati tecnici**

## Technical data

**LED TOUCH DIMMER**

2200-2700-3000-4000 K | CRI>90  
250-275-296-338 lm | 3,2 W | IP65  
5 Vdc max 2A



Corpo in alluminio anodizzato spazzolato  
(oro, rame, verde) oppure verniciato  
(bianco perlato, nero perlato, avorio)  
Brushed anodized (gold, copper, green) or painted  
aluminum body (pearly white, pearly black, ivory)

Diffusore in policarbonato prismatico  
Prismatic polycarbonate diffuser

Adatta all'uso esterno (lampada IP65) e interno  
(lampada su base di ricarica IP20)  
Suitable for outdoor (lamp IP65) and indoor use  
(lamp on charging base IP20)

Resistenza agli urti (IK07) e alla nebbia salina (1500h)  
Impact resistance (IK07) and salt spray resistance  
(1500h)

Durata 8 - 58 h, in base alla regolazione del flusso  
luminoso e alle impostazioni del Wi-Fi  
Battery lasts 8 - 58 h, depending on the luminous  
flux and Wi-Fi setting

Tempo di ricarica a 2A: 5 h  
Charging time at 2A: 5 h

Pacco batteria al litio ricaricabile e sostituibile  
Rechargeable and replaceable lithium battery pack

**AVVERTENZE / REMARKS**

Per poter funzionare, la lampada deve essere  
collegata a una rete Wi-Fi con frequenza 2,4 GHz.  
In order to work, the lamp must be connected  
to a 2.4 GHz frequency Wi-Fi network.

Firmware del dispositivo aggiornabile da remoto.  
Remotely upgradable device firmware.

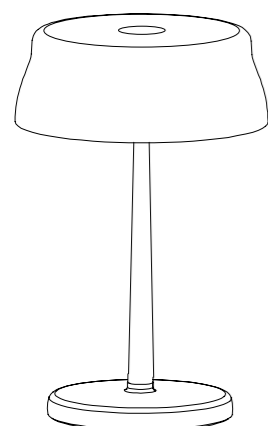

Ø 13,2 x 17 cm  
Ø 5,2 x 6,7 in

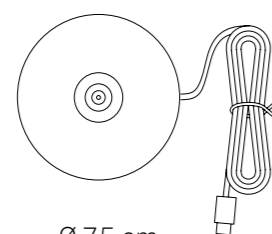

Ø 7,5 cm  
Ø 3 in

**Componenti inclusi**

Components included

Base di ricarica a contatto  
Contact charging base

**Accessori non inclusi**

Accessories not included

Caricatore / Charger  
100-240 V | USB Type A  
LD0300UC

**Finiture**

## Finishes

**LD108103**

Oro / Gold

**LD1081R3**

Rame / Copper

**LD1081V3**

Verde / Green

**LD1081B3**Bianco perlato / Pearly white  
RAL 9010**LD1081D3**Nero perlato / Pearly black  
RAL 9011**LD1081I3**Avorio / Ivory  
RAL 1015



**Dati tecnici**

## Technical data

**LED TOUCH DIMMER**

2200-2700-3000-4000 K | CRI>90  
250-275-296-338 lm | 3,2 W | IP65  
5 Vdc max 2A



Corpo in alluminio anodizzato spazzolato  
(oro, rame, verde) oppure verniciato  
(bianco perlato, nero perlato, avorio)  
Brushed anodized (gold, copper, green) or painted  
aluminum body (pearly white, pearly black, ivory)

Diffusore in policarbonato prismatico  
Prismatic polycarbonate diffuser

Adatta all'uso esterno (lampada IP65) e interno  
(lampada su base di ricarica IP20)  
Suitable for outdoor (lamp IP65) and indoor use  
(lamp on charging base IP20)

Resistenza agli urti (IK07) e alla nebbia salina (1500h)  
Impact resistance (IK07) and salt spray resistance  
(1500h)

Durata 8 - 58 h, in base alla regolazione del flusso  
luminoso e alle impostazioni del Wi-Fi  
Battery lasts 8 - 58 h, depending on the luminous  
flux and Wi-Fi setting

Tempo di ricarica a 2A: 5 h  
Charging time at 2A: 5 h

Pacco batteria al litio ricaricabile e sostituibile  
Rechargeable and replaceable lithium battery pack

**AVVERTENZE / REMARKS**

Per poter funzionare, la lampada deve essere  
collegata a una rete Wi-Fi con frequenza 2,4 GHz.  
In order to work, the lamp must be connected  
to a 2.4 GHz frequency Wi-Fi network.

Firmware del dispositivo aggiornabile da remoto.  
Remotely upgradable device firmware.

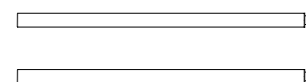
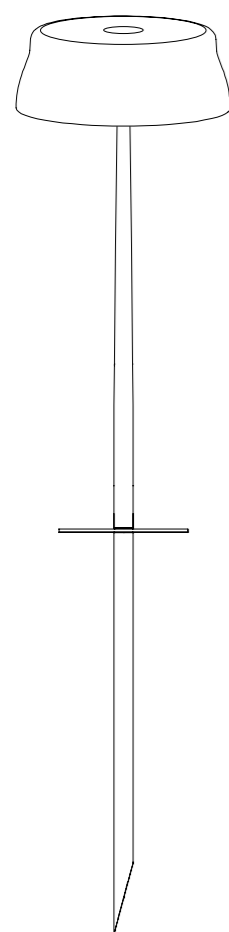

25 cm  
9,8 in

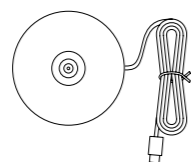

Ø 7,5 cm  
Ø 3 in

Ø 13,2 x 58-83-106 cm  
Ø 5,2 x 22,8-32,6-41,7 in

**Componenti inclusi**

Components included

Base di ricarica a contatto  
Contact charging base  
Stelo (2 pz.) / Stem (2 pcs.)

**Accessori non inclusi**

Accessories not included

Caricatore / Charger  
100-240 V | USB Type A  
LD0300UC

**Finiture**

## Finishes



**LD1083O3**  
Oro / Gold



**LD1083R3**  
Rame / Copper



**LD1083V3**  
Verde / Green



**LD1083B3**  
Bianco perlato / Pearly white  
RAL 9010



**LD1083D3**  
Nero perlato / Pearly black  
RAL 9011



**LD1083I3**  
Avorio / Ivory  
RAL 1015

**Dati tecnici**

## Technical data

**LED TOUCH DIMMER**

2200-2700-3000-4000 K | CRI>90  
250-275-296-338 lm | 3,2 W | IP65  
5 Vdc max 2A



Corpo in alluminio anodizzato spazzolato  
(oro, rame, verde) oppure verniciato  
(bianco perlato, nero perlato, avorio)  
Brushed anodized (gold, copper, green) or painted  
aluminum body (pearly white, pearly black, ivory)

Diffusore in policarbonato prismatico  
Prismatic polycarbonate diffuser

Adatta all'uso esterno (lampada IP65) e interno  
(lampada su base di ricarica IP20)  
Suitable for outdoor (lamp IP65) and indoor use  
(lamp on charging base IP20)

Resistenza agli urti (IK07) e alla nebbia salina (1500h)  
Impact resistance (IK07) and salt spray resistance  
(1500h)

Durata 8 - 58 h, in base alla regolazione del flusso  
luminoso e alle impostazioni del Wi-Fi  
Battery lasts 8 - 58 h, depending on the luminous  
flux and Wi-Fi setting

Tempo di ricarica a 2A: 5 h  
Charging time at 2A: 5 h

Pacco batteria al litio ricaricabile e sostituibile  
Rechargeable and replaceable lithium battery pack

**AVVERTENZE / REMARKS**

Per poter funzionare, la lampada deve essere  
collegata a una rete Wi-Fi con frequenza 2,4 GHz.  
In order to work, the lamp must be connected  
to a 2.4 GHz frequency Wi-Fi network.

Firmware del dispositivo aggiornabile da remoto.  
Remotely upgradable device firmware.

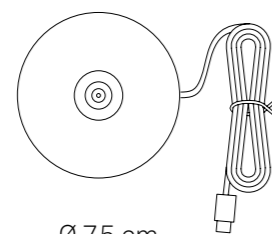
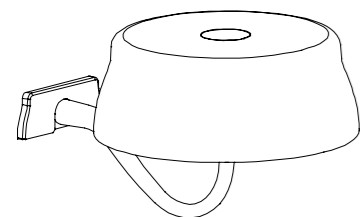

9,8 x 13,2 x 18 cm  
3,5 x 5,1 x 7,1 in

Ø 7,5 cm  
Ø 3 in

**Componenti inclusi**

Components included

Base di ricarica a contatto  
Contact charging base

**Accessori non inclusi**

Accessories not included

Caricatore / Charger  
100-240 V | USB Type A  
LD0300UC

**Finiture**

## Finishes



**LD108203**  
Oro / Gold



**LD1082R3**  
Rame / Copper



**LD1082V3**  
Verde / Green



**LD1082B3**  
Bianco perlato / Pearly white  
RAL 9010



**LD1082D3**  
Nero perlato / Pearly black  
RAL 9011



**LD1082I3**  
Avorio / Ivory  
RAL 1015

# Ofelia micro

## Tavolo pro

Table lamp pro



Ofelia micro è una lampada da tavolo a batteria, portatile e ricaricabile. Nella parte superiore della testa è presente un controllo "touch", che permette l'accensione, la regolazione dell'intensità luminosa e la selezione della temperatura di colore della luce tra 2200 K, 2700 K e 3000 K. Ofelia micro possiede inoltre la funzione di memoria dell'impostazione di dimmerazione, che memorizza gli step di dimmerazione. Grazie a un alto indice di protezione, la lampada è utilizzabile anche all'esterno. È dotata di base di ricarica a contatto; caricabatterie incluso.

Ofelia micro is a rechargeable battery-powered cordless table lamp. A "touch" control on the head allows switching on/off, dimming, and selecting the color temperature of the light (2200 K, 2700 K or 3000 K). Ofelia micro is equipped with the dimmer memory function, which adjusts the light intensity and memorizes the dimmer steps. It is suitable for both indoor and outdoor use. The lamp comes with a contact charging base; battery charger included.



Ofelia micro table lamp corten → **LD1880R3**  
Ofelia micro table lamp sand → **LD1880S3**

**Dati tecnici**

## Technical data

**LED TOUCH DIMMER**

2200-2700-3000 K | CRI>80  
183-195-216 lm | 2,2 W | IP65  
5 Vdc max 1A



Corpo in pressofusione di alluminio verniciato  
Painted die-cast aluminum body

Schermo diffusore in policarbonato  
Polycarbonate diffuser

Adatta all'uso esterno (lampada IP65) e interno  
(lampada su base di ricarica IP20)  
Suitable for outdoor (lamp IP65) and indoor use  
(lamp on charging base IP20)

Durata di circa 9 h alla massima potenza  
Battery lasts about 9 h at full power

Tempo di ricarica a 1A: 4,5 h  
Charging time at 1A: 4,5 h

Pacco batteria al litio ricaricabile e sostituibile  
Rechargeable and replaceable lithium battery pack

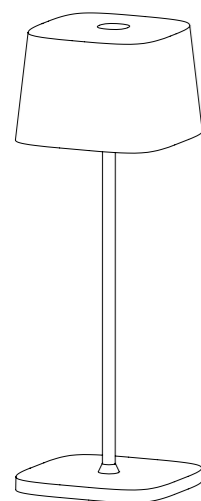

6,7 x 6,7 x 20 cm  
2,6 x 2,6 x 7,9 in

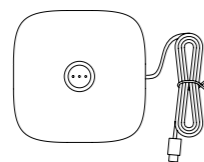

7,1 x 7,1 cm  
2,8 x 2,8 in

**Componenti inclusi**

Components included

Base di ricarica a contatto  
Contact charging base

**Accessori non inclusi**

Accessories not included

Caricatore / Charger  
100-240 V | USB Type A  
LD0490UA

**Finiture**

## Finishes



**LD1880B3**  
Bianco / White  
RAL 9016



**LD1880R3**  
Corten



**LD1880N3**  
Grigio scuro  
/ Dark gray  
RAL 7024



**LD1880S3**  
Sabbia / Sand  
RAL 1014



**LD1880G3**  
Salvia / Sage green  
Pantone 5635 U



# Olivia micro

## Tavolo pro

Table lamp pro



Olivia micro è una lampada da tavolo a batteria, portatile e ricaricabile. Nella parte superiore della testa è presente un controllo "touch", che permette l'accensione, la regolazione dell'intensità luminosa e la selezione della temperatura di colore della luce tra 2200 K, 2700 K e 3000 K. Olivia micro possiede inoltre la funzione di memoria dell'impostazione di dimmerazione, che memorizza gli step di dimmerazione. Grazie a un alto indice di protezione, la lampada è utilizzabile anche all'esterno. È dotata di base di ricarica a contatto; caricabatterie incluso.

Olivia micro is a rechargeable battery-powered cordless table lamp. A "touch" control on the head allows switching on/off, dimming, and selecting the color temperature of the light (2200 K, 2700 K or 3000 K). Olivia micro is equipped with the dimmer memory function, which adjusts the light intensity and memorizes the dimmer steps; consequently, every time it is switched on, the light intensity will correspond to that previously set. It is suitable for both indoor and outdoor use. The lamp comes with a contact charging base; battery charger included.



Olivia micro table lamp  
white → LD1840B3

**Dati tecnici**

## Technical data

**LED TOUCH DIMMER**

2200-2700-3000 K | CRI>80  
183-187-225 lm | 2,2 W | IP65  
5 Vdc max 1A



Corpo in pressofusione di alluminio verniciato  
Painted die-cast aluminum body

Schermo diffusore in policarbonato  
Polycarbonate diffuser

Adatta all'uso esterno (lampada IP65) e interno  
(lampada su base di ricarica IP20)  
Suitable for outdoor (lamp IP65) and indoor use  
(lamp on charging base IP20)

Durata di circa 9 h alla massima potenza  
Battery lasts about 9 h at full power

Tempo di ricarica a 1A: 4,5 h  
Charging time at 1A: 4,5 h

Pacco batteria al litio ricaricabile e sostituibile  
Rechargeable and replaceable lithium battery pack

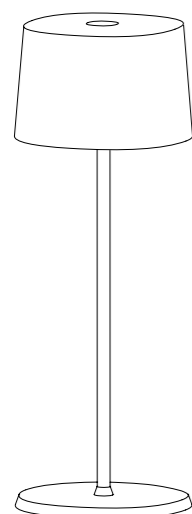

Ø 7,5 x 20 cm  
Ø 2,9 x 7,9 in

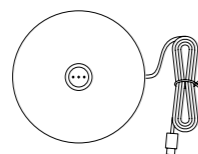

Ø 7,9 cm  
Ø 3,1 in

**Componenti inclusi**

Components included

Base di ricarica a contatto  
Contact charging base

**Accessori non inclusi**

Accessories not included

Caricatore / Charger  
100-240 V | USB Type A  
LD0490UA

**Finiture**

## Finishes



**LD1840B3**  
Bianco / White  
RAL 9016



**LD1840R3**  
Corten



**LD1840N3**  
Grigio scuro / Dark gray  
RAL 7012



**LD1840S3**  
Sabbia / Sand  
RAL 1014



Olivia table lamp dark gray → **LD0850N3**  
Olivia mini table lamp dark gray → **LD0860N3**  
Olivia micro table lamp dark gray → **LD1840N3**

# Swap

## Tavolo pro

Table lamp pro



Rispetto alla precedente, la nuova versione di Swap permette anche la regolazione dell'intensità luminosa (dimmerazione a 4 step) e la selezione della temperatura di colore della luce tra 2200 K, 2700 K e 3000 K. La nuova Swap inoltre ha altezza ridotta (29 cm). Swap è una lampada da tavolo a batteria, portatile e ricaricabile. Grazie a un alto indice di protezione, la lampada è utilizzabile anche all'esterno. Possiede un sistema di controllo elettronico che monitora e segnala l'autonomia residua della batteria, permettendo di ottimizzare le ricariche ed effettuarle sempre in maniera corretta. Swap è personalizzabile con paralumi in vetro, ceramica o tessuto, acquistabili separatamente. È dotata di base di ricarica a contatto; caricabatterie non incluso.

Compared to the previous one, the new version of Swap allows also dimming (4-step: 100%, 60%, 30%, 6%) and selecting the color temperature of the light to 2200 K, 2700 K or 3000 K. The new Swap is also smaller (29 cm / 11,4 in). Swap is a rechargeable battery-powered cordless table lamp. It is suitable for both indoor and outdoor use. An electronic control system monitors the remaining autonomy and ensures a constant luminous flux until the battery runs out. Recharging is therefore optimized and always properly done. Swap can be customized with glass, ceramic, or fabric lampshades, to be purchased separately. The lamp comes with a contact charging base; battery charger not included.



Swap table lamp black + fabric lampshade black  
→ LD1030N3 + LD102005

**Dati tecnici**

## Technical data

**LED TOUCH DIMMER**

2200-2700-3000 K | CRI&gt;90

141-168-192 lm | 2 W | IP65

5 Vdc max 2A



Corpo in pressofusione di alluminio verniciato

Painted die-cast aluminum body

Schermo diffusore in policarbonato satinato

Satin polycarbonate diffuser

Adatta all'uso esterno (lampada IP65) e interno

(lampada su base di ricarica IP20)

Suitable for outdoor (lamp IP65) and indoor use

(lamp on charging base IP20)

Durata di circa 13 h alla massima potenza

Battery lasts about 13 h at full power

Tempo di ricarica a 2A: 3 h

Charging time at 2A: 3 h

Pacco batteria al litio ricaricabile e sostituibile

Rechargeable and replaceable lithium battery pack

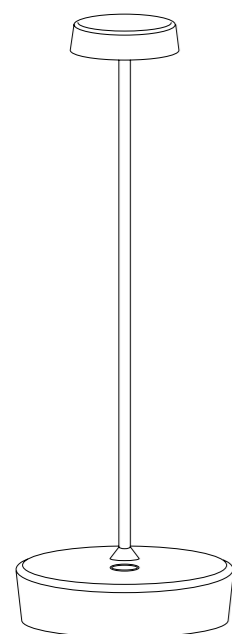

Ø 10 x 29 cm  
Ø 3,9 x 11,4 in

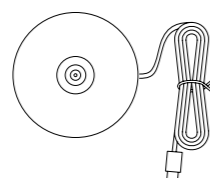

Ø 7,5 cm  
Ø 2,9 in

**Finiture**

## Finishes

**LD1030B3**

Bianco / White

RAL 9002

**LD1030R3**

Corten

**LD1030N3**

Nero / Black

RAL 9005

**Componenti inclusi**

Components included

Base di ricarica a contatto

Contact charging base

**Accessori non inclusi**

Accessories not included

Caricatore / Charger

100-240 V | USB Type A

LD0300UC

Swap table lamp black → **LD1030N3**

Resort IKOS Andalusia

Marbella-Estepona, Spain

Photo Ikos Resorts



# Poldina

## Parete pro

Wall lamp pro

## Sospensione pro

Suspension lamp pro

## Picchetto pro

Lamp with peg pro



Nuove versioni di Poldina picchetto, parete e sospensione dotate di testa magnetica che si rimuove in modo pratico e si ricarica comodamente sulla propria base di ricarica a contatto; caricabatterie incluso. Poldina è una lampada a batteria, portatile e ricaricabile con picchetto. Nella parte superiore della testa è presente un controllo "touch", che permette l'accensione, la regolazione dell'intensità luminosa e la selezione della temperatura di colore della luce tra 2200 K, 2700 K e 3000 K. Grazie a un alto indice di protezione, la lampada è utilizzabile anche all'esterno. Possiede un sistema di controllo elettronico che monitora e segnala l'autonomia residua della batteria, permettendo di ottimizzare le ricariche ed effettuarle sempre in maniera corretta.

New versions of Poldina with peg, wall, and suspension lamp with magnetic head, which can be removed easily and recharged conveniently on their own contact charging base; the battery charger is included. Poldina is a rechargeable battery-powered cordless lamp with peg. A "touch" control on the head allows switching on/off, dimming, and selecting the color temperature of the light (2200 K, 2700 K or 3000 K). It is suitable for both indoor and outdoor use. An electronic control system monitors the remaining autonomy and ensures a constant luminous flux until the battery runs out. Recharging is therefore optimized and always properly done.

Poldina suspension lamp  
white → LD0686B3





Poldina wall lamp  
dark gray → **LD0688N3**



Poldina lamp with peg  
white → **LD0682B3**

**Dati tecnici**

## Technical data

**LED TOUCH DIMMER**

2200-2700-3000 K | CRI>80  
234-251-256 lm | 2,2 W | IP54  
5 Vdc max 1A



Corpo in pressofusione di alluminio verniciato  
Painted die-cast aluminum body

Schermo diffusore in policarbonato  
Polycarbonate diffuser

Adatta all'uso esterno (lampada IP54) e interno  
(lampada su base di ricarica IP20)  
Suitable for outdoor (lamp IP54) and indoor use  
(lamp on charging base IP20)

Durata di circa 9 h alla massima potenza  
Battery lasts about 9 h at full power

Tempo di ricarica a 1A: 6 h  
Charging time at 1A: 6 h

Pacco batteria al litio ricaricabile e sostituibile  
Rechargeable and replaceable lithium battery pack

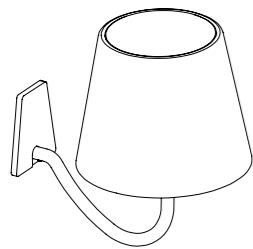

15,8 x 14 cm  
6,2 x 5,5 in

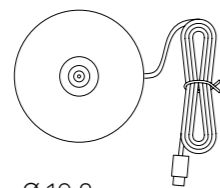

Ø 10,2 cm  
Ø 4 in

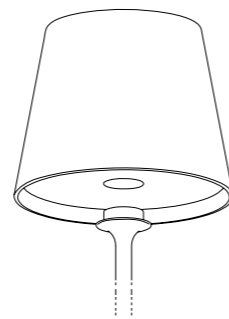
**Finiture**

## Finishes

**LD0688B3**

Bianco / White  
RAL 9003

**LD0688R3**

Corten

**LD0688N3**

Grigio scuro  
/ Dark gray

**Componenti inclusi**

Components included

Base di ricarica a contatto  
Contact charging base

**Accessori non inclusi**

Accessories not included

Caricatore / Charger  
100-240 V | USB Type A  
LD0490UA

**Dati tecnici**

## Technical data

**LED TOUCH DIMMER**

2200-2700-3000 K | CRI>80  
234-251-256 lm | 2,2 W | IP54  
5 Vdc max 1A



Corpo in pressofusione di alluminio verniciato  
Painted die-cast aluminum body

Schermo diffusore in policarbonato  
Polycarbonate diffuser

Adatta all'uso esterno (lampada IP54) e interno  
(lampada su base di ricarica IP20)  
Suitable for outdoor (lamp IP54) and indoor use  
(lamp on charging base IP20)

Durata di circa 9 h alla massima potenza  
Battery lasts about 9 h at full power

Tempo di ricarica a 1A: 6 h  
Charging time at 1A: 6 h

Pacco batteria al litio ricaricabile e sostituibile  
Rechargeable and replaceable lithium battery pack

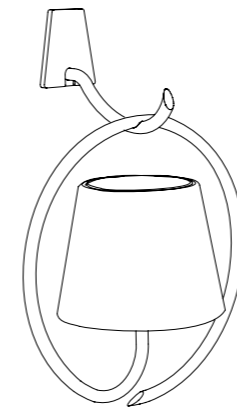

12,5 x 14 cm  
4,8 x 10,4 in

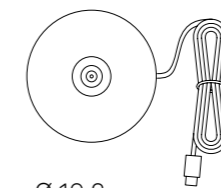

Ø 10,2 cm  
Ø 4 in

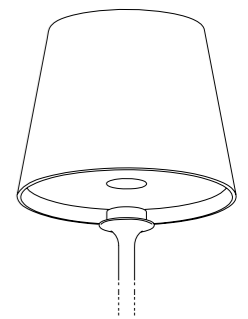
**Finiture**

## Finishes

**LD0689B3**

Bianco / White  
RAL 9003

**LD0689R3**

Corten

**LD0689N3**

Grigio scuro  
/ Dark gray

**Componenti inclusi**

Components included

Base di ricarica a contatto  
Contact charging base

**Accessori non inclusi**

Accessories not included

Caricatore / Charger  
100-240 V | USB Type A  
LD0490UA

**Dati tecnici**

## Technical data

**LED TOUCH DIMMER**

2200-2700-3000 K | CRI>80  
234-251-256 lm | 2,2 W | IP54  
5 Vdc max 1A



Corpo in pressofusione di alluminio verniciato  
Painted die-cast aluminum body

Schermo diffusore in policarbonato  
Polycarbonate diffuser

Adatta all'uso esterno (lampada IP54) e interno  
(lampada su base di ricarica IP20)  
Suitable for outdoor (lamp IP54) and indoor use  
(lamp on charging base IP20)

Durata di circa 9 h alla massima potenza  
Battery lasts about 9 h at full power

Tempo di ricarica a 1A: 6 h  
Charging time at 1A: 6 h

Pacco batteria al litio ricaricabile e sostituibile  
Rechargeable and replaceable lithium battery pack

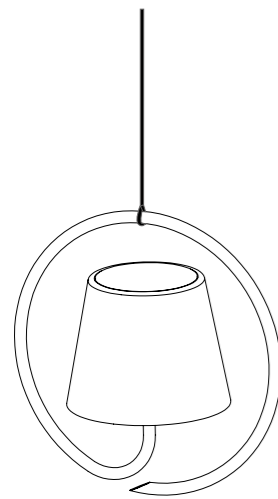

19,8 x 19,8 x 11 cm  
7,8 x 7,8 x 4,3 in

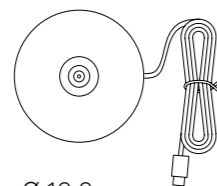

Ø 10,2 cm  
Ø 4 in

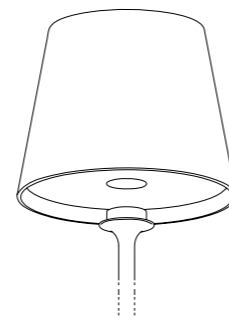
**Finiture**

## Finishes



**LD0686B3**  
Bianco / White  
RAL 9003



**LD0686R3**  
Corten



**LD0686N3**  
Grigio scuro  
/ Dark gray

**Componenti inclusi**

Components included

Base di ricarica a contatto  
Contact charging base

**Accessori non inclusi**

Accessories not included

Caricatore / Charger  
100-240 V | USB Type A  
LD0490UA

**Dati tecnici**

## Technical data

**LED TOUCH DIMMER**

2200-2700-3000 K | CRI>80  
234-251-256 lm | 2,2 W | IP54  
5 Vdc max 1A



Corpo in pressofusione di alluminio verniciato  
Painted die-cast aluminum body

Schermo diffusore in policarbonato  
Polycarbonate diffuser

Adatta all'uso esterno (lampada IP54) e interno  
(lampada su base di ricarica IP20)  
Suitable for outdoor (lamp IP54) and indoor use  
(lamp on charging base IP20)

Durata di circa 9 h alla massima potenza  
Battery lasts about 9 h at full power

Tempo di ricarica a 1A: 6 h  
Charging time at 1A: 6 h

Pacco batteria al litio ricaricabile e sostituibile  
Rechargeable and replaceable lithium battery pack

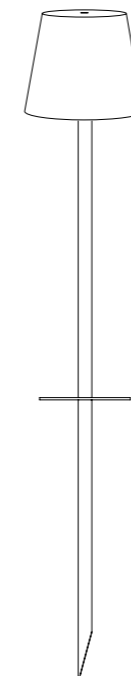

Ø 11 x 60 cm  
Ø 4,3 x 23,6 in

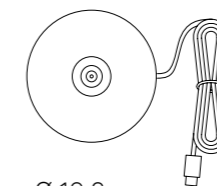

Ø 10,2 cm  
Ø 4 in

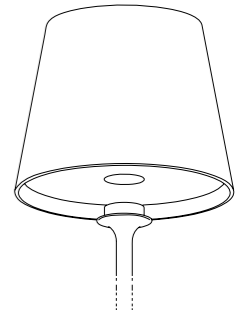
**Avvertenze / Remarks**

La stabilità della lampada è garantita  
con l'uso di massimo tre prolunghe  
The stability of the lamp is guaranteed  
when using three extensions maximum

**Finiture**

## Finishes



**LD0682B3**  
Bianco / White  
RAL 9003



**LD0682R3**  
Corten



**LD0682N3**  
Grigio scuro  
/ Dark gray

**Componenti inclusi**

Components included

Base di ricarica a contatto  
Contact charging base

**Accessori non inclusi**

Accessories not included

Caricatore / Charger  
100-240 V | USB Type A  
LD0490UA

# Poldina

## Poldina micro

**Tavolo pro**  
Table lamp pro



Video Poldina ↗



La finitura craquelé è realizzata tramite l'applicazione manuale di una foglia metallica color oro: questa lavorazione imita un disegno di screpolature superficiali, che rivelano il colore di fondo creando un gradevole contrasto cromatico e di texture.

Come le altre lampade portatili e ricaricabili già a catalogo, queste nuove versioni sono in alluminio pressofuso; si accendono, spengono e regolano con un tocco; si ricaricano con l'apposita base a contatto; permettono di scegliere la temperatura di colore della luce a LED tra 2200 K, 2700 K e 3000 K.

Adatte esclusivamente a uso interno.

The craquelé finish is created through the manual application of a gold-colored metal leaf: this process imitates a superficial pattern of cracks, which reveal the background color, creating a pleasing contrast in color and texture.

Just like the other portable and rechargeable lamps in the Zafferano catalog, these new versions are made of die-cast aluminum; they are turned on/off, and dimmed with a touch; they are recharged with a contact base; and they allow the user to choose the color temperature of the LED light between 2200 K, 2700 K, and 3000 K. The lamps are not suitable for outdoor use.



Poldina table lamp  
red - gold color leaf → **LD034OFFO**



Poldina table lamp micro  
 Capri blue - gold color leaf → **LD0490KFO**  
 Poldina table lamp  
 Avio blue - gold color leaf → **LD0340AFO**



Poldina table lamp micro  
 black - gold color leaf → **LD0490DFO**

**Dati tecnici**

## Technical data

**LED TOUCH DIMMER**

2200-2700-3000 K | CRI>80  
234-251-256 lm | 2,2 W | IP65  
50-60 Hz | 5 Vdc max 1A



Corpo in pressofusione di alluminio verniciato  
Painted die-cast aluminum body

Schermo diffusore in policarbonato  
Polycarbonate diffuser

Durata di circa 12 h alla massima potenza  
Battery lasts about 12 h at full power

Tempo di ricarica a 1A: 6/7 h  
Charging time at 1A: 6/7 h

Pacco batteria al litio ricaricabile e sostituibile  
Rechargeable and replaceable lithium battery pack

**Avvertenze**

## Remarks

Le lampade con finitura craquelé non sono adatte per uso esterno.  
The lamps with craquelé finish are not suitable for outdoor use.

Per effetto della natura manuale della tecnica adottata nella lavorazione con foglia metallica, l'aspetto finale della finitura delle lampade può risultare differente. Eventuali difformità attestano il pregio e l'unicità di ciascuna lampada e non vanno considerate come imperfezioni.

Due to the manual nature of the technique adopted in the application of the metal foil, the final appearance of the lamps' finishing can be different. Any apparent imperfections attest to the quality and exclusivity of each lamp and should not be considered as imperfections.

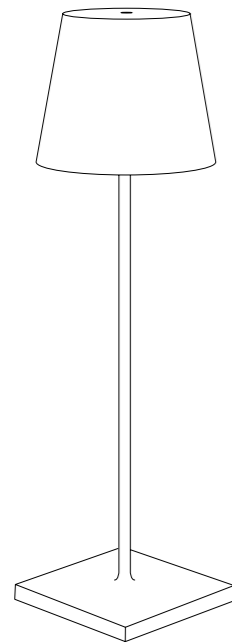

Ø 11 x 38 cm  
Ø 4,3 x 15 in

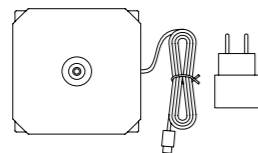

9,4 x 9,4 cm  
3,7 x 3,7 in

**Finiture**

## Finishes

**LD0340DFO**

Nero - Foglia color oro craquelé / Black - Gold color leaf  
RAL 9004

**LD0340AFO**

Blu avio - Foglia color oro craquelé / Avio blue - Gold color leaf craquelé  
Pantone 7468 U

**LD0340FFO**

Rosso - Foglia color oro craquelé / Red - Gold color leaf craquelé  
RAL 3000

**Componenti inclusi**

## Components included

Base di ricarica a contatto e caricatore  
Contact charging base and charger

**Dati tecnici**

## Technical data

**LED TOUCH DIMMER**

2200-2700-3000 K | CRI>80  
174-177-195 lm | 1,8 W | IP65  
5 Vdc max 1A



Corpo in pressofusione di alluminio verniciato  
Painted die-cast aluminum body

Schermo diffusore in policarbonato  
Polycarbonate diffuser

Durata di circa 7/8 h alla massima potenza  
Battery lasts about 7/8 h at full power

Tempo di ricarica a 1A: 3 h  
Charging time at 1A: 3 h

Pacco batteria al litio ricaricabile e sostituibile  
Rechargeable and replaceable lithium battery pack

**Avvertenze**

## Remarks

Le lampade con finitura craquelé non sono adatte per uso esterno.  
The lamps with craquelé finish are not suitable for outdoor use.

Per effetto della natura manuale della tecnica adottata nella lavorazione con foglia metallica, l'aspetto finale della finitura delle lampade può risultare differente. Eventuali difformità attestano il pregio e l'unicità di ciascuna lampada e non vanno considerate come imperfezioni.

Due to the manual nature of the technique adopted in the application of the metal foil, the final appearance of the lamps' finishing can be different. Any apparent imperfections attest to the quality and exclusivity of each lamp and should not be considered as imperfections.

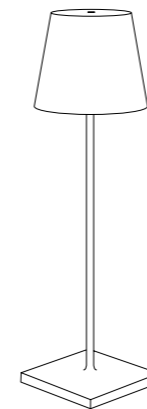

Ø 7 x 27,5 cm  
Ø 2,8 x 10,8 in

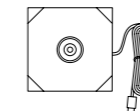

6,7 x 6,7 cm  
2,6 x 2,6 in

**Finiture**

## Finishes

**LD0490DFO**

Nero - Foglia color oro craquelé / Black - Gold color leaf  
RAL 9004

**LD0490KFO**

Blu Capri - Foglia color oro craquelé / Capri blue - Gold color leaf craquelé  
RAL 5019

**LD0490FFO**

Rosso - Foglia color oro craquelé / Red - Gold color leaf craquelé  
RAL 3000

**Componenti inclusi**

## Components included

Base di ricarica a contatto  
Contact charging base

**Accessori non inclusi**

## Accessories not included

Caricatore / Charger  
100-240 V | USB Type A  
LD0490UA

# Pina

## Tavolo pro

Table lamp pro



Pina è una lampada da tavolo a batteria, portatile e ricaricabile. Sulla base è presente un controllo "touch", che permette l'accensione, la regolazione dell'intensità luminosa e la selezione della temperatura di colore della luce tra 2200 K, 2700 K e 3000 K. Possiede un sistema di controllo elettronico che monitora e segnala l'autonomia residua della batteria, permettendo di ottimizzare le ricariche ed effettuarle sempre in maniera corretta. È dotata di base di ricarica a contatto; caricabatterie incluso.

Pina is a rechargeable battery-powered cordless table lamp. A "touch" control on the base allows switching on/off, dimming, and selecting the color temperature of the light (2200 K, 2700 K or 3000 K). An electronic control system monitors the remaining autonomy and ensures a constant luminous flux until the battery runs out. Recharging is therefore optimized and always properly done. The lamp comes with a contact charging base; battery charger included.



Pina table lamp  
black - gold color leaf → **LD1650DFO**



**Dati tecnici**

## Technical data

**LED TOUCH DIMMER**

2200-2700-3000 K | CRI>80  
178-204-206 lm | 2,2 W | IP54  
50-60 Hz | 5 Vdc max 1A



Corpo in pressofusione di alluminio verniciato

Painted die-cast aluminum body

Schermo diffusore in policarbonato

Polycarbonate diffuser

Durata di circa 12 h alla massima potenza

Battery lasts about 12 h at full power

Tempo di ricarica a 1A: 6/7 h

Charging time at 1A: 6/7 h

Pacco batteria al litio ricaricabile e sostituibile

Rechargeable and replaceable lithium battery pack

**Avvertenze**

## Remarks

Le lampade con finitura craquelé non sono adatte per uso esterno.

The lamps with craquelé finish are not suitable for outdoor use.

Per effetto della natura manuale della tecnica adottata nella lavorazione con foglia metallica, l'aspetto finale della finitura delle lampade può risultare differente. Eventuali difformità attestano il pregio e l'unicità di ciascuna lampada e non vanno considerate come imperfezioni.

Due to the manual nature of the technique adopted in the application of the metal foil, the final appearance of the lamps' finishing can be different. Any apparent imperfections attest to the quality and exclusivity of each lamp and should not be considered as imperfections.

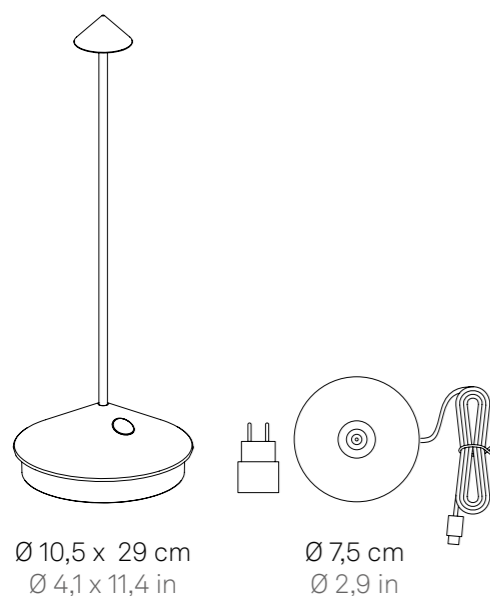
**Finiture**

## Finishes

**LD1650DFO**

Nero - Foglia color oro craquelé  
/ Black - Gold color leaf

RAL 9004

**Componenti inclusi**

## Components included

Base di ricarica a contatto e caricatore  
Contact charging base and charger

Pina table lamp  
black - gold color leaf → **LD1650DFO**



# Home Solar

## Paletto Bollard



Paletto adatto all'uso esterno, disponibile in due modelli: basso, alto. Ha struttura in pressofusione di alluminio verniciato grigio scuro o corten e diffusore in polycarbonato trasparente. Home Solar è privo di collegamento alla rete elettrica e dotato di pannello solare, sensore crepuscolare, sensore di movimento e picchetto per installazione diretta su terreno. I sensori della lampada sono comandati da due interruttori: quando il sensore crepuscolare è attivo (☾) e rileva una luminosità ambientale minore di 150 Lux, la lampada si accende al 50% della sua intensità; quando anche il sensore di movimento è attivo (👤) e rileva un movimento, la lampada si accende al massimo della sua potenza per poi abbassarla al 10%.

Bollard lamp for outdoor use, available in two models: low and high. It has a dark grey or corten painted die-cast aluminum frame and a transparent polycarbonate diffuser. Home Solar is mains-independent and fitted with a solar panel, dusk sensor, motion sensor and peg for inserting it directly into the ground. The lamp sensors are controlled by two switches: when the dusk sensor is active (☾) and detects an ambient brightness of less than 150 Lux, the lamp switches on at 50% of its intensity. When the motion sensor is active (👤), too, and detects movement, the lamp switches on at full power, and then lower its intensity to 10%.



Home Solar bollard  
dark gray → LD0257G3

## Dati tecnici

### Technical data

**LED**  
3000 K | 3,7 V | CRI>84  
415 lm | 2,2 W | IP54



Corpo in pressofusione di alluminio verniciato  
Die-cast painted aluminum body  
Schermo diffusore in policarbonato  
Polycarbonate diffuser  
Lampada dotata di sensore crepuscolare  
e di movimento  
Lamp fitted with dusk and motion sensors  
Ricarica: 6-8 h (luce solare)  
Charge: 6-8 h (sunshine)  
Durata batteria: luce piena 10-11h; micro 20 - 25h  
Work time: Full power 10-11h; energy saving 20 - 25h

### Componenti inclusi

#### Components included

Viti per cemento e picchetto in metallo  
Screws and metal peg

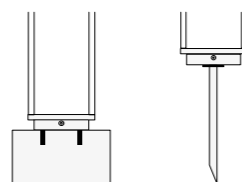

### Accessori non inclusi

#### Accessories not included

Base zavorrata / Stabilizing base  
Accessorio per stabilizzare la lampada  
senza ancorarla al terreno.  
Accessory to stabilise the lamp without  
anchoring it to the ground.



16 x 16 x 0,8 cm  
6,3 x 6,3 x 0,3 in



**LD0255R3**  
Corten



**LD0255G3**  
Grigio scuro  
Dark gray

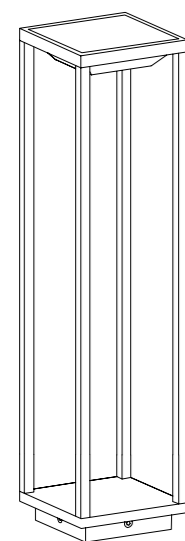

14 x 14 x 50 cm  
5,5 x 5,5 x 19,7 in

## Finiture

### Finishes



**LD0256R3**  
Corten



**LD0256G3**  
Grigio scuro  
/ Dark gray

## Dati tecnici

### Technical data

**LED**  
3000 K | 3,7 V | CRI>84  
415 lm | 2,2 W | IP54



Corpo in pressofusione di alluminio verniciato  
Die-cast painted aluminum body  
Schermo diffusore in policarbonato  
Polycarbonate diffuser  
Lampada dotata di sensore crepuscolare  
e di movimento  
Lamp fitted with dusk and motion sensors  
Ricarica: 6-8 h (luce solare)  
Charge: 6-8 h (sunshine)  
Durata batteria: luce piena 10-11h; micro 20 - 25h  
Work time: Full power 10-11h; energy saving 20 - 25h

### Componenti inclusi

#### Components included

Viti per cemento e picchetto in metallo  
Screws and metal peg

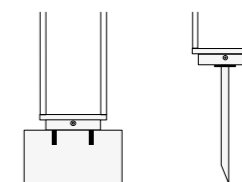

### Accessori non inclusi

#### Accessories not included

Base zavorrata / Stabilizing base  
Accessorio per stabilizzare la lampada  
senza ancorarla al terreno.  
Accessory to stabilise the lamp without  
anchoring it to the ground.

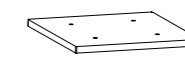

16 x 16 x 0,8 cm  
6,3 x 6,3 x 0,3 in



**LD0255R3**  
Corten



**LD0255G3**  
Grigio scuro  
Dark gray

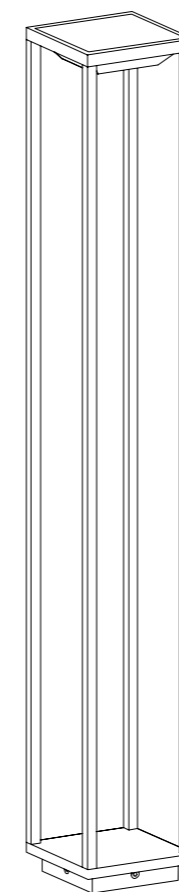

14 x 14 x 100 cm  
5,5 x 5,5 x 39,4 in

## Finiture

### Finishes



**LD0257R3**  
Corten



**LD0257G3**  
Grigio scuro  
/ Dark gray

# Liolà

## Tavolo Table



Tavolini composti da un piano rotondo in termoplastico e tre gambe in legno di frassino, disponibili in otto varianti: alto oppure basso, con piano bianco oppure nero, con gambe in colore naturale oppure verniciate nere. Realizzati con materiali di qualità, in collaborazione con artigiani e laboratori selezionati, i tavolini Liolà sono progettati per un uso professionale nel settore ristorazione, ma sono adatti anche all'uso domestico, anche come svuotatasche o per appendere una borsa.

Tables composed of a round thermoplastic top and three ash wood legs, available in eight variations: tall or low, with a white or black top, with legs in natural color or painted black. Liolà tables are made in collaboration with selected artisans and workshops, using high quality materials, and are designed for professional use in restaurants, but are also suitable for home use, for example as a tray or to hang a bag.



Liolà high table  
black - natural wood → **ZLS0104**



Liolà table  
black - black wood → **ZLS0005**



Liolà high table  
white - natural wood → **ZLS0101**



Liola table white - natural wood → **ZLS0001**  
 Liola high table white - natural wood → **ZLS0101**

### Dati tecnici Technical data

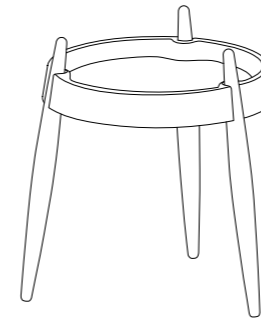

Ø 40 x 47 cm  
 Ø 15,7 x 18,5 in

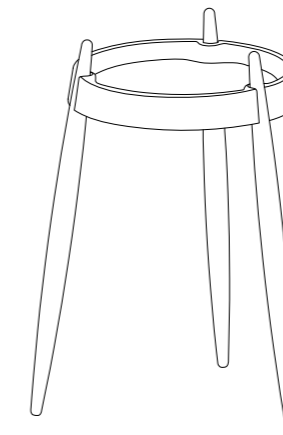

Ø 40 x 67 cm  
 Ø 15,7 x 26,4 in

Piano in termoplastico  
 Thermoplastic top  
 Gambe in legno di frassino  
 Wood legs



### Finiture Finishes



**ZLS0001**  
 Bianco - Frassino naturale  
 White - Natural wood



**ZLS0002**  
 Bianco - Frassino nero  
 White - Black wood



**ZLS0004**  
 Nero - Frassino naturale  
 Black - Natural wood



**ZLS0005**  
 Nero - Frassino nero  
 Black - Black wood



**ZLS0101**  
 Bianco - Frassino naturale  
 White - Natural wood



**ZLS0102**  
 Bianco - Frassino nero  
 White - Black wood



**ZLS0104**  
 Nero - Frassino naturale  
 Black - Natural wood



**ZLS0105**  
 Nero - Frassino nero  
 Black - Black wood

# Accessori

## Accessories



Super O  
Modulo luce aggiuntivo  
Additional lighting module  
Bianco / White  
**LD1060B3**



Super O  
Modulo luce aggiuntivo  
Additional lighting module  
Nero / Black  
**LD1060N3**

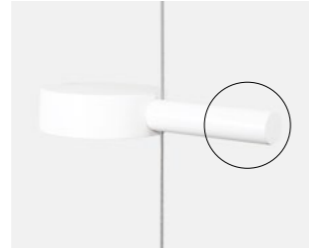

Super O  
Contrappeso per modulo luce  
Counterweight for additional  
light module  
Bianco / White  
**LD1063B3**

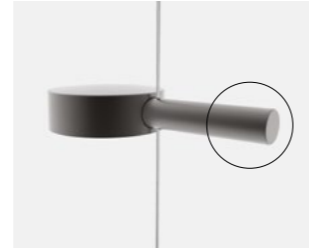

Super O  
Contrappeso per modulo luce  
Counterweight for additional  
light module  
Nero / Black  
**LD1063N3**



Poldina  
Copper  
**LD0349A3** Blu Avio / Avio blue  
**LD0349B3** Bianco / White  
**LD0349D3** Nero / Black  
**LD0349F3** Rosso / Red  
**LD0349G3** Salvia / Sage green  
**LD0349S3** Sabbia / Sand

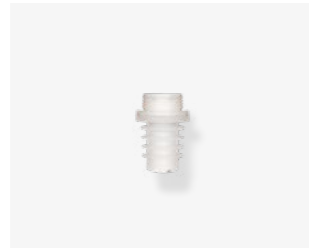

Poldina  
Tappo per testa in silicone  
Silicone head plug  
**LD0349TP**



Caricabatterie con entrata USB  
USB port power charger  
**LD0490UA**  
  
INPUT: AC 100-240V | 50-60Hz  
OUTPUT: 5Vdc - max 1 A



Caricabatterie con doppia entrata USB  
e spina intercambiabile (EU/USA/UK)  
Dual USB port power charger and an  
interchangeable plug suitable for EU/  
USA/UK  
**LD0300UC**  
  
INPUT: AC 100-240V | 50-60Hz  
OUTPUT: 5Vdc - max 2,1 A



Caricatore multiplo 8 prese USB  
8 x USB ports multi charger  
  
40W  
INPUT: AC 100-240V | 50-60Hz  
OUTPUT: 5Vdc - max 8A (8 pcs.)  
**LD0340RA**



Poldina table lamp  
Base di ricarica a contatto  
multipla 6 posti  
Multi-contact charging base  
6 slots  
**LD0350RP**

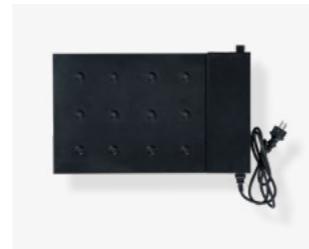

Poldina micro  
Base di ricarica a contatto  
multipla 12 posti  
Multi-contact charging base  
12 slots  
**LD0490RP**



Amelie, Circe, Ofelia micro,  
Olivia micro  
Base di ricarica a contatto  
multipla 6 posti  
Multi-contact charging base  
6 slots  
**LD0870RP**

## Accessori e ricambi

### Accessories and spare parts



Amelie collection  
Base di ricarica a contatto  
Contact charging base  
**LD1090RB**

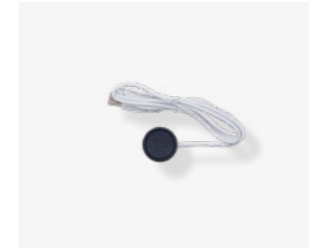

Super O collection  
Disco per ricarica a contatto  
Contact charging puck  
**LD1060RB**



Circe table lamp  
Base di ricarica a contatto  
Contact charging base  
**LD1005RB**

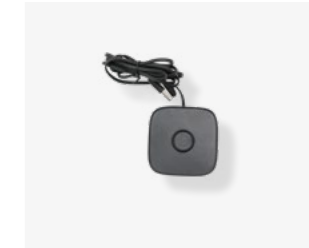

Ofelia micro  
Base di ricarica a contatto  
Contact charging base  
**LD1880RB**

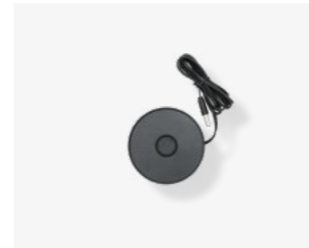

Olivia micro  
Base di ricarica a contatto  
Contact charging base  
**LD1840RB**



Sister Light collection  
Base di ricarica a contatto  
Contact charging base  
**LD1080RB**



Sister Light table lamp  
Adattatore per base di ricarica  
Charging base adapter  
**LD1080BS**



Pina  
Base di ricarica a contatto  
Contact charging base  
**LD0650RB**



Poldina table lamp  
Base di ricarica a contatto  
Contact charging base  
**LD0350RB**



Poldina micro  
Base di ricarica a contatto  
Contact charging base  
**LD0490RB**



Poldina suspension lamp,  
Poldina wall lamp,  
Poldina lamp with peg  
Base di ricarica a contatto  
Contact charging base  
**LD0688RB**

**Base di ricarica a contatto multipla (max 6 posti)**

Multi-contact charging base (max 6 slots)

→ Poldina (table lamp), Pina



→ LD0350RP

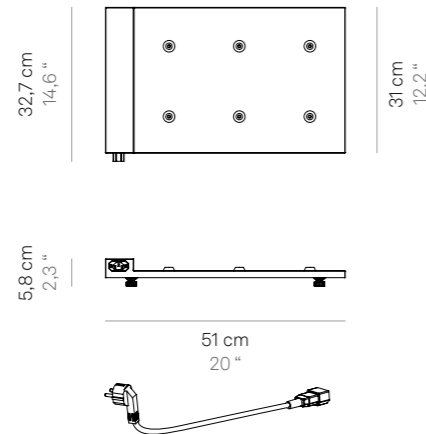

35W  
INPUT: AC 100-240V | 50-60Hz  
OUTPUT: 5Vdc max 6A

Base di ricarica a contatto multipla (max 6 posti) e modulare: più basi possono essere collegate in sequenza per caricare contemporaneamente più lampade. Particolarmente adatto all'uso professionale. Modular multi-contact (max 6 slots) charging base: they can be connected in sequence to simultaneously charge multiple set of lamps. Particularly suitable for professional use.

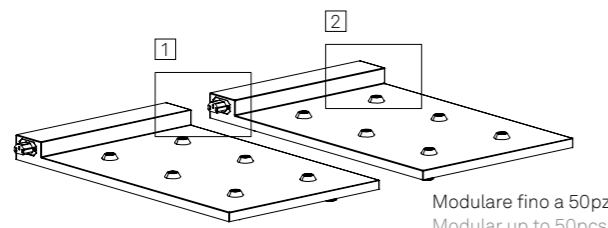
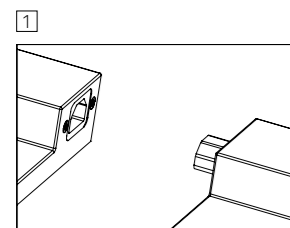

Modulare fino a 50pz  
Modular up to 50pcs

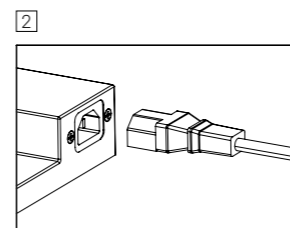
**Base di ricarica a contatto multipla (max 12 posti)**

Multi-contact charging base (max 12 slots)

→ Poldina micro



→ LD0490RP

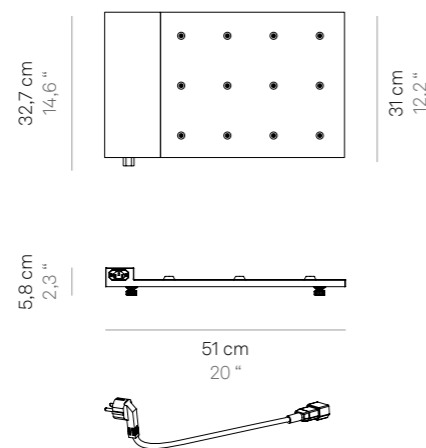

35W  
INPUT: AC 100-240V | 50-60Hz  
OUTPUT: 5Vdc max 12A

Base di ricarica a contatto multipla (max 12 posti) e modulare: più basi possono essere collegate in sequenza per caricare contemporaneamente più lampade. Particolarmente adatto all'uso professionale. Modular multi-contact (max 12 slots) charging base: they can be connected in sequence to simultaneously charge multiple set of lamps. Particularly suitable for professional use.

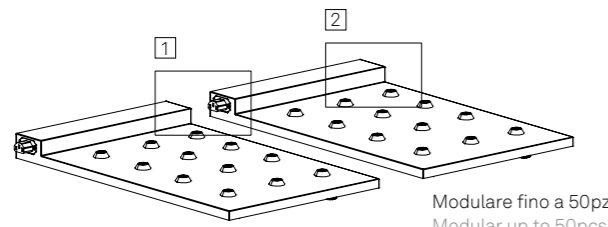
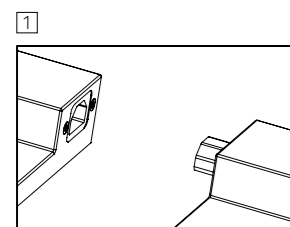

Modulare fino a 50pz  
Modular up to 50pcs

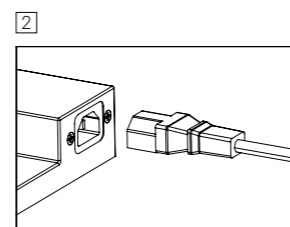
**Base di ricarica a contatto multipla (max 6 posti)**

Multi-contact charging base (max 6 slots)

→ Amelie, Circe, Olivia micro, Ofelia micro



→ LD0870RP

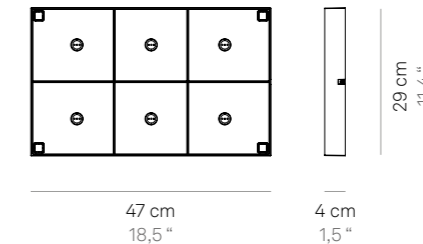

45W  
INPUT: AC 100-240V | 50-60Hz  
OUTPUT: 9Vdc max 5A

Base di ricarica a contatto multipla (max 6 posti) e modulare: più basi possono essere impilate (fino a max 3 livelli) per caricare contemporaneamente più lampade. Particolarmente adatto all'uso professionale. Modular multi-contact (max 6 slots) charging base: they can be stacked (up to max 3 levels) to simultaneously charge multiple set of lamps. Particularly suitable for professional use.

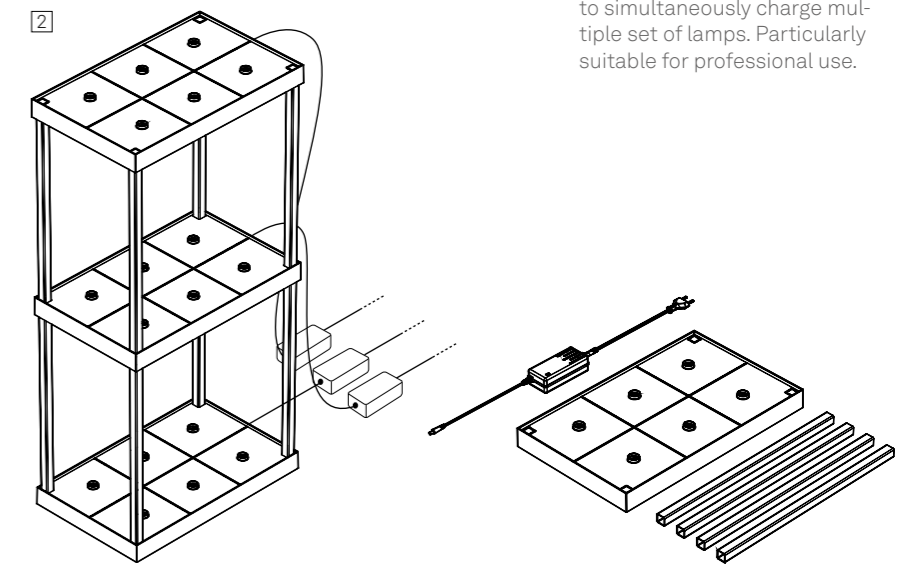
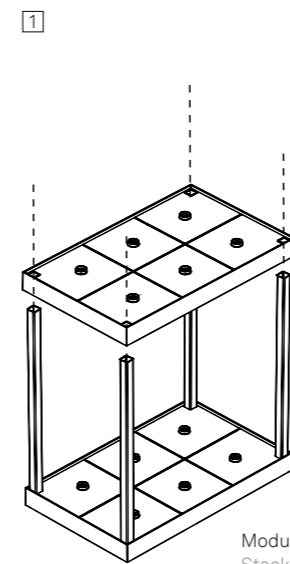

Modulare fino a 3 livelli.  
Stackable up to 3 levels.

**Caricatore multiplo 8 prese USB**

8 x USB ports multi charger



→ LD0340RA

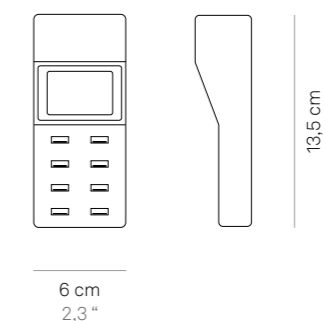

40W  
INPUT: AC 100-240V | 50-60Hz  
OUTPUT: 5Vdc - max 8A (8 pcs.)

Caricatore multipresa USB (8 x USB-A). Permette la carica di max 8 dispositivi contemporaneamente. Un display mostra graficamente il livello delle batterie in ricarica. Particolarmente adatto all'uso professionale. USB multi-socket charger (8 x USB-A). Can charge of up to 8 devices simultaneously. A graphic display shows the level of the batteries being charged. Particularly suitable for professional use.



## Batterie ricaricabili

### Rechargeable batteries

Le batterie ricaricabili sono soggette ad usura. La vita delle batterie, il cui standard è di circa 450 ricariche, può essere ridotta da alcuni fattori come: ① la modalità non corretta di ricarica (la lampada va ricaricata quando è scarica: circa il 10% della sua autonomia residua); ② lunghi periodi di stazionamento senza utilizzo; ③ lunghi periodi di stazionamento su base di ricarica in tensione anche se la lampada risulta carica; ④ l'utilizzo di accessori non originali per la ricarica; ⑤ l'esposizione del prodotto a temperature molto alte o molto fredde. Quando le lampade non si ricaricano più o l'autonomia risulta molto ridotta, le batterie devono essere sostituite. I ricambi delle lampade ricaricabili Zafferano sono disponibili a catalogo e identificati con apposito codice. La garanzia sulle batterie è valida solo per difetti di fabbricazione, che si manifestano al primo utilizzo.

All rechargeable batteries are subject to wear when used. The life of batteries, which can generally be recharged 450 times, may be reduced by certain factors: ① incorrect recharging mode (the lamp must be recharged when it is flat: about 10% of its remaining autonomy); ② when left unused for a long time; ③ when left for a long time on a live recharging base even if the lamp is recharged; ④ when non-original accessories are used for recharging; ⑤ when the product is exposed to very high or very low temperatures. When the lamps no longer recharge or their autonomy after recharging is very short, the batteries must be replaced. Spare parts for Zafferano rechargeable lamps can be found in the catalogue and identified by a special code. The warranty for batteries is only valid for manufacturing defects, if occurred at first use.

**BAT04701906701900**  
Pacco batteria sostitutiva singola (necessari 2 pz. per **Pina, Home Solar**)  
Single replacement battery pack (x2 pcs. needed for **Pina table lamp, Home Solar**)

3,7V | 1x2200mA/H



**BAT04704004001000**  
Pacco batteria sostitutiva singola (necessario 1 pz. per **Poldina micro**)  
Single replacement battery pack (1 pc. needed for **Poldina micro table lamp**)

3,7V | 1x1900mA/H



**BAT04709003005000**  
Pacco batteria sostitutiva doppia (necessario 1 pz. per **Ofelia micro, Olivia micro**)  
Double replacement battery pack (1 pc. needed for **Ofelia micro table lamp, Olivia micro table lamp**)

3,7V | 2x1500mA/H



**Video tutorial / Tutorial video**  
sostituzione batterie  
battery replacement

**BAT04703706701900**  
Pacco batteria sostitutiva doppia (necessario 1 pz. per **Amelie, Circe, Poldina tavolo, Poldina picchetto, Poldina sospensione, Poldina parete**)  
Double replacement battery pack (1 pc. needed for **Amelie, Circe, Poldina table lamp, Poldina lamp with peg, Poldina suspension lamp, Poldina wall lamp**)

3,7V | 2x2200mA/H



**BAT04703706701901**  
Pacco batteria sostitutiva doppia (necessario 2 pz. per **Super O**)  
Double replacement battery pack (2 pcs. needed for **Super O**)

3,7V | 2x2500mA/H



**BAT04705506701900**  
Pacco batteria sostitutiva tripla (necessario 1 pz. per **Sister Light tavolo, Sister Light mini tavolo, Sister Light picchetto, Sister Light parete**)  
Triple replacement battery pack (x1 pc. needed for **Sister Light table lamp, Sister Light mini table lamp, Sister Light lamp with peg, Sister Light wall lamp**)

3,7V | 7500mA/H





**CE**  
 Dichiaro che il prodotto soddisfa gli standard dell'UE per la salute, la sicurezza e la protezione ambientale.  
 Declares that the product meets EU standards for health, safety, and environmental protection.



**CLASS II**  
 Apparecchio dotato di doppio isolamento e/o isolamento rinforzato in ogni parte e senza dispositivo di messa a terra.  
 Light fitting equipped with double isolation and/or isolation reinforced in every part and without earthing device.



**CLASS III**  
 Apparecchio basato su un'alimentazione a bassissima tensione di sicurezza, in cui non si producono tensioni superiori alla stessa.  
 Light fitting based on a very low safety voltage power supply, in which no tensions higher than the same are produced.



**IP PROTECTION DEGREE**  
 IP20: apparecchio protetto dalla penetrazione di corpi solidi di dimensioni maggiori a 12mm e non protetto dai liquidi.  
 IP54: apparecchio protetto da polveri e da spruzzi d'acqua.  
 IP65: apparecchio fortemente protetto da polveri e da getti d'acqua.  
 IP20: protected from the penetration of solid objects greater than 12 mm and non protected from liquids.  
 IP54: protected from dust and splashing water.  
 IP65: highly protected from dust and water jets.



**DIMMABLE**  
 Indica che è possibile regolare l'intensità luminosa della lampada.  
 Indicates that the light intensity of the lamp can be adjusted.

Headquarters  
**Zafferano SRL**  
 Viale dell'industria 26  
 31055 Quinto di Treviso (TV), Italy  
 T +39 0422 470507  
 F +39 0422 470400  
 vendite@zafferanoitalia.com

Subsidiary  
**Zafferano America LLC**  
 301 Penhorn Avenue  
 Suite 5,  
 Secaucus, NJ 07094  
 T +1 888 744 5277  
 info@zafferanoamerica.com

Stores  
**Zafferano Store Treviso**  
 Viale dell'Industria, 26  
 Quinto di Treviso (Italy)

**Zafferano Store Milano**  
 Via Fatebenefratelli, 23  
 Milan (Italy)

**Zafferano Store New York**  
 121 Varick Street  
 New York, NY 10013 (USA)

Art Direction, Graphic Design  
 Zafferano Design  
 © Copyright Zafferano SRL

Printing  
 L'Artegrafica  
 December 2023

NEWLAP24-01

L'azienda si riserva di apportare modifiche e/o migliorie di carattere tecnico ed estetico ai propri modelli e prodotti in qualsiasi momento e senza preavviso.  
 The company reserves the right to make modifications and improvements of a technical or aesthetic nature to the products at any time without notice.

Il prodotto è protetto da garanzia, a norma di legge.  
 The product is covered by a warranty, according to the law.